



# **Expansion of Hong Kong International Airport into a Three-Runway System**

Marine Travel Routes and Management Plan for  
Construction and Associated Vessels  
Document No. 355482/06/04.02

September 2024

Airport Authority Hong Kong

This page left intentionally blank for pagination.

Mott MacDonald  
3/F Manulife Place  
348 Kwun Tong Road  
Kwun Tong  
Kowloon  
Hong Kong

T +852 2828 5757  
mottmac.hk

# **Expansion of Hong Kong International Airport into a Three-Runway System**

Marine Travel Routes and Management Plan for  
Construction and Associated Vessels  
Document No. 355482/06/04.02

September 2024

Airport Authority Hong Kong

# Issue and Revision Record

Revision	Date	Originator	Checker	Approver	Description
A	Feb 2015	Various	Eric Ching	Anne F. Kerr	First Draft
B	May 2015	Various	Eric Ching	Anne F. Kerr	Second Draft
C	Jun 2015	Various	Eric Ching	Anne F. Kerr	Third Draft
D	Aug 2015	Various	Eric Ching	Jon Pavey	Fourth Draft
E	Aug 2015	Various	Eric Ching	Jon Pavey	Fifth Draft
F	Sep 2015	Various	Eric Ching	Jon Pavey	Sixth Draft
G	Nov 2015	Various	Terence Kong	Eric Ching	Seventh Draft
H	Dec 2015	Various	Terence Kong	Eric Ching	Final
I	Nov 2016	Various	Julia Chan	Eric Ching	6-month Review
J	Jan 2020	Various	Julia Chan	Eric Ching	Review Update
K	Mar 2020	Various	Julia Chan	Eric Ching	Review Update
L	Apr 2020	Various	Julia Chan	Eric Ching	Review Update
M	May 2020	Various	Julia Chan	Eric Ching	Review Update
N	Jul 2020	Various	Julia Chan	Eric Ching	Review Update
O	Oct 2020	Various	Julia Chan	Eric Ching	Review Update
P	Mar 2022	Various	Julia Chan	Eric Ching	Review Update
Q	May 2022	Various	Julia Chan	Eric Ching	Review Update

**Document reference:** 355482 |

## Information class: Standard

This document is issued for the party which commissioned it and for specific purposes connected with the above-captioned project only. It should not be relied upon by any other party or used for any other purpose.

We accept no responsibility for the consequences of this document being relied upon by any other party, or being used for any other purpose, or containing any error or omission which is due to an error or omission in data supplied to us by other parties.

This document contains confidential information and proprietary intellectual property. It should not be shown to other parties without consent from us and from the party which commissioned it.

---

# Contents

<b>1</b>	<b>Introduction</b>	<b>1</b>
1.1	Background	1
1.2	Purpose of the Plan	1
<b>2</b>	<b>Project Description</b>	<b>3</b>
2.1	Introduction	3
2.2	Non-construction Related Activities	3
2.3	Construction Methods	3
2.3.1	Land Formation	3
2.3.2	Diversion of Submarine Aviation Fuel Pipelines	4
2.3.3	Diversion of Submarine 11kV Cables	4
2.3.4	Construction of Runway Approach Lights	5
2.3.5	Construction of Hong Kong International Airport Approach Area (HKIAAA) Marker Buoys	5
2.3.6	General Activities	5
2.4	Types of Working Vessels Involved	5
2.4.1	Non-self-propelled Vessels	6
2.4.2	Self-propelled Vessels	6
2.4.3	Vessels Delivering Materials to and from the Project Site	7
2.5	Structure of the Plan	7
<b>3</b>	<b>Technical Guidelines to Avoid Water Quality Impacts during Operation of Barges and Construction Vessels</b>	<b>8</b>
3.1	Introduction	8
3.2	Local and International Standards and Regulations	8
3.2.1	Water Pollution Control Ordinance (Cap. 358)	8
3.2.2	The Technical Memorandum - Standards for Effluents Discharged into Drainage and Sewerage Systems, Inland and Coastal Waters (TM-DSS) (Cap. 358AK)	8
3.2.3	International Convention for the Prevention of Pollution from Ships (MARPOL 73/78)	8
3.2.4	Marine Parks Ordinance (Cap.476)	8
3.2.5	Others Relevant Legislation and Requirements	9
3.3	Guidelines for Preventing Water Quality Impacts	9
3.3.1	General	9
3.3.2	Avoidance of Sediment Plumes	9
3.3.3	Wastewater	10
3.3.4	Spillage / Leakages	10
3.4	Specific Requirements for Managing Marine Construction Activities	10

<b>4</b>	<b>Practices or Measures to Keep Construction-related Vessels to a Practical Minimum</b>	<b>12</b>
4.1	Rolling Vessel Plan	12
4.2	Marine Traffic Control	12
4.3	Reduction of Waste Materials	12
4.4	Provision of Regular Trips of Passenger Vessels Services	13
<b>5</b>	<b>Predefined and Regular Routes for Construction Vessels</b>	<b>14</b>
5.1	Considerations of Setting Marine Travel Route	14
5.1.1	Existing Navigation Channel and Marine Traffic	14
5.1.2	Restricted Areas, Height Restriction and Speed Limit	14
5.1.3	Water Depth	14
5.1.4	Other Marine Facilities	15
5.2	Design of Marine Travel Route for Construction Vessels	19
5.2.1	General Arrangements for Construction Vessels	19
5.2.2	Construction Vessels Transit Route	19
5.2.3	General Arrangements for Existing and Future Marine Facilities	20
5.2.4	Guidelines for Safe Vessel Operations Travelling Outside and Within the Works Area	21
5.2.5	Contingency Arrangements	24
<b>6</b>	<b>Skipper Training and Guidelines for Safe Vessel Operations in the Presence of the CWDs</b>	<b>26</b>
6.1	Impacts on CWDs and Precautionary Measures	26
6.2	Skipper Training	26
6.3	Guidelines for Safe Vessel Operations in the Presence of the CWDs	26
<b>7</b>	<b>Speed Limit of 10-knot for Construction Vessels within Works Area &amp; CWD Hotspots</b>	<b>32</b>
7.1	Works Area	32
7.2	Dolphin Protection Areas	32
7.3	Chinese White Dolphin “Hotspot” Areas	32
<b>8</b>	<b>Implementation and Monitoring</b>	<b>41</b>
8.1	Method of Implementation and Monitoring	41
8.1.1	Marine Traffic Monitoring Systems	41
8.1.2	Record of Travel Route	42
8.1.3	Water Quality and Vessel Movement	42
8.2	Supervision Staff	43
<b>9</b>	<b>Summary and Conclusion</b>	<b>44</b>
<b>10</b>	<b>References</b>	<b>45</b>

Appendix A Project Location	46
Appendix B Working Vessels Involved in the Construction Activities	47
Appendix C Code of Conduct in the Presence of Dolphins	52
Appendix D Implementation Schedule for Marine Travel Routes and Management Plan for Construction and Associated Vessels	53

## Tables

Table 2-1: Indicative Working Vessels Involved in the Construction Activities	5
Table 7-1: Criteria for each 1 km <sup>2</sup> grid in defining the dolphin habitat index, based on the ranking of four factors (i.e. current density by DPSE, historical density by DPSE, habitat rating and 50% core area usage by CWDs)	33

## Figures

Figure 5-1a: Existing and Future Marine Facilities and Dolphin Protection Areas Before Interim Two Runway System (I-2RS)	
Figure 5-1b: Existing and Future Marine Facilities and Dolphin Protection Areas After I-2RS and Before Designation of NLMP	
Figure 5-1c: Existing and Future Marine Facilities and Dolphin Protection Areas After Designation of NLMP	
Figure 5-2: Indicative Marine Travel Route with Forecast Construction Traffic Movements during Peak Period per Day After Commencement of Reclamation Before I-2RS (modified from BMT, 2014)	
Figure 5-3: Indicative Marine Travel Route with Forecast Construction Traffic Movements on Average per Day After Commencement of Reclamation Before I-2RS (modified from BMT, 2014)	
Figure 5-4a: Indicative Marine Travel Route After I-2RS and Before Designation of NLMP	
Figure 5-4b: Indicative Marine Travel Route After Designation of NLMP	
Figure 5-5: Potential Routes to Typhoon Shelters	
Figure 6-1a: Overall Principles for Construction Vessels Travel Within / Outside the Works Area Before I-2RS	
Figure 6-1b: Overall Principles for Construction Vessels Travel Within / Outside the Works Area After I-2RS and Before Designation of NLMP	
Figure 6-1c: Overall Principles for Construction Vessels Travel Within / Outside the Works Area After Designation of NLMP	
Figure 6-1d: No Entry Zone and 10-knot Speed Limit Area for Construction Vessels Travel Within / Outside the Works Area After Designation of NLMP	
Figure 7-1: Current density of Chinese White Dolphins with corrected survey effort per km <sup>2</sup> in waters around Lantau Island between January – December 2022 (number within grids)	

represent “DPSE” = no. of dolphins per 100 units of survey effort; from Hung, 2023). In the dolphin habitat index developed for this plan, DPSE of 0.0 – 20.0 is rated as “Low”, 20.1 – 40.0 as “Medium” and 40.1 or above as “High”.

Figure 7-2: Historical density of Chinese White Dolphins with correct survey effort per km<sup>2</sup> in waters around Lantau Island during 2001 – 2012 (numbers within grids represent “DPSE” = no. of dolphins per 100 units of survey effort; from Hung, 2014). In the dolphin habitat index developed for this plan, DPSE of 0.0 – 20.0 is rated as “Low”, 20.1 – 40.0 as “Medium” and 40.1 or above as “High”

Figure 7-3: Habitat rating of Chinese White Dolphins in Hong Kong using quantitative habitat use information collected during 2001 – 2012 (number with grids represents the sum of scores totalled from 10 selection criteria; from Hung, 2014). In the dolphin habitat index developed for this plan, habitat rating of 0 – 10 is rated as “Low”, 11 – 20 as “Medium”, and 21 or above as “High”

Figure 7-4: Number of individual Chinese White Dolphins with their 50% utilization distribution (UD) core areas overlapped with each 1 km<sup>2</sup> grid in waters around Lantau Island from 2001 – 2012 (Hung, 2014). In the dolphin habitat index developed for this plan, 50% core area of 0-10 is rated as “Low”, 11-30 as “Medium”, and 31 or above as “High”

Figure 7-5a: Dolphin Habitat Index and Marine Travel Routes Before I-2RS

Figure 7-5b: Dolphin Habitat Index and Marine Travel Routes After I-2RS and Before Designation of NLMP

Figure 7-5c: Dolphin Habitat Index and Marine Travel Routes After Designation of NLMP

Figure 8-1: Typical Marine Traffic Monitoring System



# 1 Introduction

## 1.1 Background

The Government of the Hong Kong Special Administrative Region (HKSAR) approved in principle the adoption of the Three-Runway System (3RS) as the future development option for Hong Kong International Airport (HKIA) for planning purposes on 20 March 2012, and also approved the recommendation of Airport Authority Hong Kong (AAHK) to proceed with the statutory environmental impact assessment (EIA). An EIA study brief (ESB-250/2012) for the 3RS project (henceforth referred to as the 'project') was issued by the Environmental Protection Department (EPD) on 10 August 2012. The EIA report has been prepared according to the EIA study brief requirements, which identified 12 key environmental assessment aspects to be addressed as part of the EIA study. On 7 November 2014, the EIA for the project (EIA Register No.: AEIAR-185/2014) was approved and an Environmental Permit (EP) (Permit No.: EP-489/2014) was issued for the project. The project locations with indication of land formation area including area reserved for aviation support development are shown in **Appendix A**.

The project is located on a new land formation immediately north of HKIA in North Lantau, covering a permanent footprint of approximately 650 ha. As stated in the approved EIA report, the project primarily comprises:

- New third runway with associated taxiways, aprons and aircraft stands;
- New passenger concourse building;
- Expansion of the existing Terminal 2 (T2) building; and
- Related airside and landside works, and associated ancillary and supporting facilities.

Mott MacDonald Hong Kong Limited is commissioned to prepare the Marine Travel Routes and Management Plan for Construction and Associated Vessels in accordance with the Environmental Permit to minimise the chance of vessel collision and the disturbance to the Chinese White Dolphins (CWD) during construction of the project.

## 1.2 Purpose of the Plan

This Marine Travel Routes and Management Plan for Construction and Associated Vessels was prepared and submitted in December 2015 in accordance with Condition 2.9 of the Environmental Permit (EP-489/2014). The Plan which described the regular marine travel routes of construction and associated vessels travelling to and from the Works Area, and relevant specifications to minimise the chance of vessel collision and the disturbance to the CWDs was approved in December 2015.

The purpose of the updated Marine Travel Routes and Management Plan for Construction and Associated Vessels (hereafter as the "Updated Plan") is to align with the updated construction requirements and programme, and designation of North Lantau Marine Park (NLMP) with effect on 1 November 2024. At the time of submitting this Updated Plan, marine-based Deep Cement Mixing Works and filling operations of the reclamation works have been completed. General activities such as delivering site materials and construction equipment, manoeuvring and anchoring of working barges or vessels, transportation of site staff, and exportation of surplus fill and / or waste for disposal will continue. The plan ensures aviation and marine safety requirements during the commissioning of the 3RS and designation of NLMP.

The implementation schedule of the recommended mitigation measures for the Plan is presented in **Appendix D**. This Updated Plan includes but not limited to the following information / specifications:

- i. detailed technical guidelines to avoid adverse water quality impacts for compliance of Contractors over the operation of barges and construction vessels to be deployed in the project area (**Section 3**);
- ii. practices or measures to keep stationary and moving construction-related vessels, including construction plants, construction vessels, delivery barges, and passenger vessels for staff, to a practical minimum (**Section 4**);
- iii. predefined and regular routes for construction vessels covering waters both inside and outside the Works Area (**Section 5**);
- iv. training with proper record for all vessel captains working in the area, prior to construction, to educate them about local cetaceans, as well as guidelines for safe vessel operations in the presence of the CWD (**Section 6**); and
- v. speed limit of 10-knot for construction vessels within Works Area and hotspots of the CWD (**Section 7**).

## 2 Project Description

### 2.1 Introduction

This section presents a brief description of the types of 3RS construction activities that are relevant to this Plan. Details of working vessels that would typically be utilised for each type of construction activity were also described, in order to identify areas where potential impacts to water quality and CWDs could be minimised during the construction phase, and as such fulfilling the requirements of the EP as stated in **Section 1.2**.

### 2.2 Non-construction Related Activities

There are various types of non-construction related activities proposed to be undertaken during the construction phase. These included survey boats, monitoring vessels and sampling vessels related to environmental monitoring and auditing (EM&A) and site investigation vessels related to quality control measures, and voluntary patrol vessels at the marine park and Dolphin Protection Areas. The above mentioned vessels will not form part of the construction and associated vessels under this Updated Plan.

### 2.3 Construction Methods

The 3RS project is located on a new land formation immediately north of HKIA in North Lantau, covering a permanent footprint of approximately 650 ha. For the purpose of this Updated Plan, only those construction activities which are marine-based or would utilize construction and associated vessels are described in this section. Relevant activities include land formation, diversion of submarine aviation fuel pipelines, diversion of submarine 11kV cables, construction of runway approach lights, construction of marker buoys and general activities.

#### 2.3.1 Land Formation

The main components of land formation comprise modification of the existing seawall, ground improvement of the underlying marine sediments, new seawall construction and filling. Ground improvement in lieu of dredging was adopted to minimise any impacts to water quality and marine ecology. Marine site investigation (S.I.) works were conducted regularly as quality control measures during ground improvement and reclamation works.

##### 2.3.1.1 Modification of Existing Seawall

To connect the new land formation area with the existing airport island, the seawall along the northern perimeter of the airport island needs to be modified to interface with the new land formation.

##### 2.3.1.2 Geotextile and Sand Blanket Laying

The methods for sand blanket laying would include closed grab dredgers, hydraulic pumping with spreader pontoon and other methods as shown in Silt Curtain Deployment Plan. Where using closed grab dredgers, a proposed silt curtain would fully enclose the cage surrounding the grab of the dredger (such full enclosures are typically associated with higher silt removal efficiency). Where hydraulic pumping with spreader pontoon is adopted, a double-layer floating silt curtain surrounding the sand blanket laying activity would be implemented. For other methods, Contractor's customised cage type silt curtain would be implemented. Upon commencement of the marine filling activities with advance seawall and enhanced silt curtain surrounding the reclamation area, the remaining sand blanket laying activities would be protected by the seawall and the enhanced silt curtain. The localised full-enclosure-type silt curtains surrounding the sand

blanket laying activities would no longer be required. The geotextile and sand blanket laying works were completed in May 2020.

#### 2.3.1.3 Ground Improvement of the Underlying Marine Sediments

Various ground improvement methods, including Deep Cement Mixing (DCM)<sup>1</sup>, and Prefabricated Vertical Drains (PVD) were proposed for the 3RS project. The ground improvement methods to be adopted varied depending on location (within or outside the contamination mud pit (CMP) boundaries) and the 'land type' to be supported. The ground improvement works were completed in April 2022.

#### 2.3.1.4 Seawall Construction

The majority of the seawalls for the airport expansion comprised sloping seawalls, except for some localised areas where vertical seawalls are required. These seawalls covers the entire boundary of the new land formation. Due to spatial constraints within each Works Area, sectional construction of the seawall was not commence until after the completion of the respective seawall ground improvement works in that section. The seawall construction works were completed in April 2022.

#### 2.3.1.5 Marine and Land Filling

Different fill materials including rock fill, public fill, sand fill, rock armour and graded filter layer will be used to form the land and seawalls. Seawalls comprised rock fill as the seawall core, and rock armour and graded filter layer to form the protective layers. The marine filling works were completed in the first quarter of 2023.

### 2.3.2 Diversion of Submarine Aviation Fuel Pipelines

Diversion of the existing submarine aviation fuel pipelines used a horizontal directional drilling (HDD) method forming pipeline tunned by drilling through bedrock from a launching site located at the west of the airport island to the daylighting point adjacent to the Aviation Fuel Receiving Facility at Sha Chau, outside the land formation footprint (see **Appendix A** - Figure). The diversion of submarine aviation fuel pipeline was completed in January 2019. Although the diversion of aviation fuel pipelines did not involve major marine-based construction activities, a positioning barge was deployed to check the alignment of horizontal directional drill pipe (HDDP) and a floating platform was set up in the Sha Chau and Lung Kwu Chau Marine Park (SCLKCMP) to support the HDD daylighting and pipelines connection works on land. Transportation vessels were also used to transport site staff to the Works Area located within the marine park.

### 2.3.3 Diversion of Submarine 11kV Cables

The existing 11kV Submarine Cable connecting HKIA and Sha Chau required to be diverted to facilitate the new land formation. A short section of marine approach trench (approximately 20 m) was formed to facilitate the cable laying operation. The submarine cable laying and burying works were conducted by water jetting method, which fed high pressure water into the blade of the jet sled and the blade be lowered until full penetration. The diversion of Submarine 11kV cables was completed in January 2019.

---

<sup>1</sup> Note that DCM refers to a ground improvement method / soil mixing technique in which cement slurry is mixed with soft soil to produce a cemented soil compound with higher strength and stiffness than the original soil. Different variants of this method have been widely adopted in other countries and exist under different terms such as Cement Deep Mixing (CDM), Cutter Soil Mixing (CSM), Cement Deep Soil Mixing (CDSM), Deep Soil Mixing (DSM) or Deep Jet Mixing (DJM) (all based on the same operating principals).

### 2.3.4 Construction of Runway Approach Lights

The approach lights will extend off the eastern and western edges of the new land formation into the adjacent marine waters. The section of the approach lights in marine waters was installed on small marine structures supported with piles, on top of which the light barrettes will be placed. A maintenance deck in the form of a metal bridge extended from each end of the runway was installed to allow access to these structures. The eastern section of the approach lights for the third runway was extended into an area of CMPs. Therefore, the area beneath each light stand will be improved with DCM prior to piling. The runway approach lights construction works were completed in October 2021.

### 2.3.5 Construction of Hong Kong International Airport Approach Area (HKIAAA) Marker Buoys

After the completion of the reclamation works of about 650 hectares of land to the north of the existing Airport Island, part of the waters within the HKIAAA No.3 and No.7 for the previous operation of two-runway system at the northern part of HKIA would no longer exist. In order to keep the aviation and marine safety requirements for the commissioning of the third runway, the boundaries of HKIAAA No.3 and No.7 are required to refine accordingly. To demarcate the HKIAAA boundary for 3RS, marker buoys would be installed along the boundary of the HKIAAA. The HKIAAA marker buoys installation works were completed in first quarter of 2022.

### 2.3.6 General Activities

General activities include material storage and delivery of other site materials and construction equipment, manoeuvring and anchoring of working barges or vessels, transportation of site staff, exportation of surplus fill and/ or waste for disposal and marine site investigation works.

## 2.4 Types of Working Vessels Involved

The various types of vessels used during the construction phases are described in **Table 2-1** below, making reference to the detailed design and construction details provided by the Contractors. Photos of the recommended construction and associated vessels are presented in **Appendix B**.

**Table 2-1: Indicative Working Vessels Involved in the Construction Activities**

Construction Activities	Working Vessels Involved <sup>1</sup>
Modification of Existing Seawall	<ul style="list-style-type: none"> <li>• Crane Barge</li> </ul>
<ul style="list-style-type: none"> <li>• Moving armour rocks</li> </ul>	<ul style="list-style-type: none"> <li>• Derrick Barge</li> </ul>
Installation of the Geotextile Layer and Sand Blanket (Completed)	<ul style="list-style-type: none"> <li>• Derrick Barge</li> </ul>
<ul style="list-style-type: none"> <li>• Laying geotextile</li> <li>• Sand Delivery</li> <li>• Placing / Pumping Sand</li> </ul>	<ul style="list-style-type: none"> <li>• Spreader Pontoon</li> <li>• Crane Barge</li> </ul>
Ground Improvement (Completed)	<ul style="list-style-type: none"> <li>• Derrick Barge</li> </ul>
<ul style="list-style-type: none"> <li>• Deep Cement Mixing (DCM) Ground Improvement</li> <li>• Prefabricated Vertical Drains (PVD) Ground improvement</li> </ul>	<ul style="list-style-type: none"> <li>• Crane Barge</li> <li>• DCM Barge</li> <li>• Cement silo barge</li> <li>• PVD Barge</li> <li>• Hopper barge</li> </ul>

Construction Activities	Working Vessels Involved <sup>1</sup>
Seawall Construction (Completed)	<ul style="list-style-type: none"> <li>• Crane Barge</li> <li>• Flat-top Barge</li> <li>• Derrick Barge</li> </ul>
Marine and Land Filling <sup>2</sup> (Marine Filling Completed)	<ul style="list-style-type: none"> <li>• Trailing Suction Hopper Dredger (TSHD)</li> <li>• Flat-top Barge</li> <li>• Crane Barge</li> <li>• Spreader Pontoon</li> <li>• Pelican Barge</li> <li>• Hopper Barge</li> <li>• Derrick Barge</li> </ul>
Diversion of Aviation Fuel Pipeline (Completed)	<ul style="list-style-type: none"> <li>• Floating Platform</li> <li>• Positioning Barge</li> </ul>
Diversion of Submarine 11kV Cables (Completed)	<ul style="list-style-type: none"> <li>• Water Jetting Barge</li> <li>• Derrick Barge</li> <li>• Crane Barge</li> </ul>
Construction of Runway Approach Lights and Marker Buoys <sup>3</sup> (Completed)	<ul style="list-style-type: none"> <li>• Crane Barge</li> <li>• Flat-top Barge</li> <li>• Derrick Barge</li> </ul>
General Activities	<ul style="list-style-type: none"> <li>• Flat-top Barge</li> <li>• Pelican Barge</li> <li>• Crane Barge</li> <li>• Hopper Barge</li> <li>• Tug Boats</li> <li>• Anchor Boats</li> <li>• Transportation Boats / Ferry</li> <li>• Small Tug Boats</li> <li>• Guard Boat</li> <li>• Jack-up Barge</li> <li>• Roro Barge</li> </ul>

Note:

- <sup>1</sup> The working vessels involved in the aforesaid construction methods and activities will be subject to change and the availability of construction plant.
- <sup>2</sup> This may involve transshipment operation of sand fill materials from ocean going vessels to derrick lighters or pelican barges at off-site anchorage areas before transporting the sand fill materials to the Works Area.
- <sup>3</sup> The working vessels involved in construction of Marker Buoys were subject to change based on the construction development.

The construction and associated vessels are divided into three categories:

#### 2.4.1 Non-self-propelled Vessels

This category includes crane barges, derrick barge, floating platforms, spreader pontoons, hopper barges, DCM barges, water jetting barge and flat-top barges etc. These types of vessel will be stationary within the Works Area most of the time and the positioning / re-positioning of these vessel types by tug boats and anchor boats will be carried out at slow speed.

#### 2.4.2 Self-propelled Vessels

This category includes TSHD, pelican barges, tug boats, anchor boats, transportation boats, and transportation boats. When moving to and from the Works Area, these vessels may be able to travel at slow to intermediate speed (up to around 20 knots). However, in the vicinity of the project area they mainly operate at slow moving speed (around 5 knots up to maximum 10 knots). These

vessels generally have high manoeuvrability. For the transportation boats, the travelling speed shall be less than 10 knots.

### 2.4.3 Vessels Delivering Materials to and from the Project Site

This category includes TSHD, pelican barges, derrick barges, hopper barges and flat-top barges, etc. These are large, slow moving vessels while the last three types of barges are non-self-propelled vessels that rely on tug boats for manoeuvring.

## 2.5 Structure of the Plan

The following sections outline the control measures and restrictions proposed for Contractors intending to operate construction and associated vessels in undertaking their 3RS works activities. **Section 3** details the technical guidelines for preventing water quality impacts from vessel operation, **Section 4** details the practices and measures for keeping the number of construction-related vessels to a minimum, **Section 5** includes further detail on predefined and regular routes for construction vessels with **Section 6** providing detail on skipper training and guidelines for vessel operations in the presence of dolphins. Thereafter, **Section 7** provides further details on construction vessel speed limits in CWD hotspot areas and **Section 8** provides new information on how the measures are to be implemented and monitored.

## 3 Technical Guidelines to Avoid Water Quality Impacts during Operation of Barges and Construction Vessels

### 3.1 Introduction

Potential water quality impacts associated with the operation of construction-related vessels include sediment plumes, wastewater discharge and accidental spillage of chemicals and fuel / oil into the marine environment. To control and minimise the identified water quality impacts, the Contractors must ensure compliance with relevant environmental legislation and regulations as well as implementation of appropriate mitigation and precautionary measures. The relevant requirements are summarised in the sections below.

### 3.2 Local and International Standards and Regulations

#### 3.2.1 Water Pollution Control Ordinance (Cap. 358)

All discharges into any drainage or sewerage systems, or inland or coastal waters, or into the ground, within a Water Control Zone are controlled under the Water Pollution Control Ordinance (WPCO), except the discharge of domestic sewage into foul sewers or the discharge of unpolluted water into storm drains or into the waters of Hong Kong. Construction site discharges are controlled under the WPCO. As such, all construction-related discharges for the Project must comply with the WPCO, and the terms and conditions of a valid WPCO licence.

No construction vessel or construction-related vessel is permitted to discharge any wastewater into the marine environment without a valid WPCO licence. Each Contractor shall be responsible for the application of any licences required for the construction vessels and construction activities under that contract.

#### 3.2.2 The Technical Memorandum - Standards for Effluents Discharged into Drainage and Sewerage Systems, Inland and Coastal Waters (TM-DSS) (Cap. 358AK)

This memorandum specifies the water quality standards for different types of discharges and discharge locations. All wastewater generated by the Project shall be treated to meet the standards specified in the TM-DSS.

#### 3.2.3 International Convention for the Prevention of Pollution from Ships (MARPOL 73/78)

All Hong Kong ships wherever they are and all ships within Hong Kong waters are required to follow the MARPOL 73/78 regulations for prevention and minimisation of pollution to the environment due to ship operations. The Convention specifies requirements for addressing pollution to the environment in respect of (i) oil; (ii) noxious liquid substances; (iii) harmful substances in packaged form; (iv) sewage; (v) garbage and (vi) air pollution from ships. In all cases where the equivalent local regulation is not available, the MARPOL 73/78 regulations shall be applied.

#### 3.2.4 Marine Parks Ordinance (Cap.476)

The Marine Parks Ordinance (Cap.476) provides a legal framework for designation, control and management of Marine Parks and Marine Reserves. The Marine Parks and Marine Reserves



Regulation also provides the prohibition and control of certain activities in Marine Parks or Marine Reserves.

All construction and associated vessels shall travel through the Marine Parks and Marine Reserves at a 10-knot speed limit, and shall not moor or anchor in a marine park and marine reserve without authorization. The Contractor shall strictly follow the Marine Parks Ordinance (Cap.476) within the Marine Parks.

### 3.2.5 Others Relevant Legislation and Requirements

Other relevant legislation and requirements that are related to the prevention of water quality impact include the following:

- Waste Disposal Ordinance (Cap. 354);
- Waste Disposal (Chemical Waste) (General) Regulation (Cap. 354C);
- Dumping at Sea Ordinance (Cap. 466); and  
Public Cleansing and Prevention of Nuisances Regulation (Cap. 132BK).

## 3.3 Guidelines for Preventing Water Quality Impacts

To prevent and minimise the risk of water quality impacts, the following measures shall be implemented when applicable/ necessary for all marine vessel-related activities during construction phase of the Project.

### 3.3.1 General

- Decks and exposed fittings of barges and hoppers shall be cleaned of excess materials before moving the vessels.
- Pipes and fittings connecting the barges with the spreaders shall be properly fitted and checked for leakages before operation, and any identified leaking pipes shall be repaired immediately.
- Adequate freeboard shall be maintained on barges to minimise the likelihood of decks being washed by wave action.
- All vessels shall not be permitted to release any foam, oil, grease, litter or other objectionable matter into the waters within and surrounding the Works Area.
- Regular inspection for objectionable matter (e.g. foam, oil, grease, scum and floating refuse) in the waters within and surrounding the Works Area shall be conducted. Such objectionable matter, if present, shall be regularly collected and removed to an appropriate off-site disposal facility.
- All vessels shall follow the International Convention for the Control and Management of Ship's Ballast Water and Sediments to minimise the release of exotic species or pollutants through ballast water.

### 3.3.2 Avoidance of Sediment Plumes

- Avoid filling barges and hoppers to a level which may cause overflow of materials or water pollution during loading and/ or transportation.
- All vessels stationed or manoeuvring outside the boundary of the silt curtains surrounding the Works Area shall maintain adequate clearance between the vessel and the seabed at all states of the tide to prevent undue turbidity generated by turbulence from vessel movement or propeller wash. Vessel captains will be reminded during the Skipper Training Workshops to regularly check the Sound Navigation and Ranging System (SONAR) or marine map of Hong Kong showing the water depth, in order to remain alert to shallow water areas when navigating to the Works Area with sufficient clearance between the vessel draft and the seabed.

- Anchors shall only be deployed when vessels required for station at designated location for long period or for other valid safety reasons to avoid frequent anchoring and de-anchoring activities. Anchoring and de-anchoring activities shall be avoided when the vessels are still moving to minimise disturbance to seabed.

### 3.3.3 Wastewater

- Any wash water from cleaning of decks and equipment shall be treated to meet WPCO / TM-DSS requirements before discharge. The Contractors shall obtain the licence(s) required for discharge of treated wastewater.
- No direct discharge of contaminated water is permitted.

### 3.3.4 Spillage / Leakages

- Bottom opening of barges shall be fitted with tight fitting seals to prevent leakage of material.
- All fuel tanks / fuel storage containers (excluding fuels stored as part of vessel bunkers) shall be secured (within an enclosed area if possible) and contained within a sealed and bunded area. The bunded area shall have capacity to contain at least 110% of the storage capacity of the largest tank / container held within the bunded area.
- All fuel tanks / fuel storage containers shall be inspected daily to ensure the containers are in good condition and there are no openings which oil / chemical can possibly leak out. Any damage / openings to the storage area and drip trays shall be repaired or replaced immediately.
- Where chemicals are temporarily taken outside the sheltered chemical storage area, the chemicals including the drip trays / bund shall be covered by waterproof tarpaulins and kept free of rainwater.

## 3.4 Specific Requirements for Managing Marine Construction Activities

Potential cumulative water quality impacts associated with concurrent operation of a large number of construction vessels shall be controlled and minimised as follows:

- Construction activities shall be programmed and coordinated to minimise the number of vessels required. A 3-month rolling programme for construction vessel activity for each Works Area shall be prepared by each Contractor and updated monthly to demonstrate the required number of vessels are necessary with AAHK/Project Manager (PM) endorsement.
- Vessel movements shall be kept to a minimum. The practices to keep construction-related vessels to a minimum are presented in **Section 4**.
- All vessels shall not exceed a speed of 10-knot within the boundary of the Works Area as shown in **Figures 6-1a, 6-1b, 6-1c and 6-1d**.
- Vessels shall follow the pre-defined routes and prescribed marine traffic arrangements to minimise the risk of collision. Details of the predefined routes are presented in **Section 5**.
- Construction and associated vessels shall not enter the Dolphin Protection Areas as shown in **Figures 5-1a, 5-1b and 5-1c** and described in **Section 7.2** under normal circumstances.
- All vessels shall neither enter the Marine Parks, nor anchor / stopover within the Marine Parks area without authorization.
- After designation of NLMP, the construction and associated vessels have to pass through the NLMP when coming / leaving the Works Area. The construction and associated vessels shall minimize their travelling route within the NLMP, adhere to at a 10-knot speed limit (AFCD, n.d.) when passing through the NLMP and not anchor or stopover within the NLMP.

The above items will fall under the control of the marine traffic monitoring system arrangements detailed in **Section 8** and these arrangements will be monitored by the staff of the associated on-shore control room.

## 4 Practices or Measures to Keep Construction-related Vessels to a Practical Minimum

### 4.1 Rolling Vessel Plan

The vessels mentioned in Table 2 1 are not expected to be present all at the same time due to phasing of construction activities. Good planning of construction vessel activities can contribute to effective management of the number of vessels on site to a minimal level. All works Contractors will be required to submit a monthly construction vessel activities programme to report the actual construction vessels deployed and marine movements together with the planned vessel movements on a 3-month rolling basis, so as to identify the anticipated construction vessels movements for the coming 3 months for optimum control and effective monitoring. The number and types of construction vessels proposed by the Contractors will be checked by AAHK/PM to ensure the proposed deployment is necessary and minimal. Such rolling vessel plans provide a means of actively managing vessel activities during the 3RS project. Staff in the on-shore control room will coordinate between multiple Contractors making reference to respective vessel plans to ensure the vessel activities follow the rolling vessel plan, the marine travel routes prior to entrance to the Works Area as well as the movements inside and outside the Works Area. The on-shore control room staff will also communicate with Contractors frequently to check if they have minimised the number of vessels in accordance with their rolling plans and mooring activities of vessel outside the Works Area especially at dolphin hotspots will also be monitored. The Contractor shall submit updated contact list to AAHK / on-shore control room staff regularly to ensure that all the construction vessels skippers could be efficiently contacted by on-shore control room staff. Any idling barges and barges being for overhaul maintenance work shall be demobilized off site as early as practical.

### 4.2 Marine Traffic Control

To minimise the potential temporary disturbance due to the delivery barges and stationary construction vessels at north of the airport platform during construction, marine construction traffic including construction plant, construction vessels and barges shall be kept to a practical minimum. Idle vessels in the Works Area shall be avoided as far as practicable, and this can be achieved through good construction programme planning that seeks to maximise productivity and storage capacity from each plant/ vessel, minimise the number of plant/ vessels required along with minimising required occupancy within the Works Area. The overall objective is to keep the number of working or stationary vessels present on-site to the minimum at anytime. AAHK has established a Marine Traffic Monitoring System and associated on-shore control room to monitor, manage and communicate with construction vessels. Arrangements for overall management of the system and details on the on-shore control room are detailed in **Section 8.1**.

### 4.3 Reduction of Waste Materials

For land formation activities during the 3RS project, every effort will be taken to minimise the export of surplus construction and demolition (C&D) waste to landfill, hence reducing the vessel movements for C&D waste exportation. For example, where possible the extent of excavation will be minimized. Construction materials will also be planned and stocked carefully to avoid unnecessary generation of waste and this will be facilitated through the preparation and implementation of contract-specific Waste Management Plans.

#### **4.4 Provision of Regular Trips of Passenger Vessels Services**

In order to keep the number of passenger vessels for staff to a minimum and to ensure efficient transportation of staff between Works Area and piers, relevant Contractors will be required to provide regular passenger vessels on a scheduled basis, in particular during peak working hours. Staff shall travel to and from Works Area from designated landing points with high utilisation of each passenger vessel to be safeguarded (e.g. ad hoc transportation of a few staff by large vessels shall be avoided as far as practicable). Scheduled ferry service between Tuen Mun / Tung Chung / Tsuen Wan / project site offices on existing airport island to and from the reclaimed land are provided. Relevant Contractors are required to monitor the numbers of passengers and passenger vessels in operation as works progress and shall ensure that the operations of passenger vessels for staff are kept to a practicable minimum.

## 5 Predefined and Regular Routes for Construction Vessels

### 5.1 Considerations of Setting Marine Travel Route

The predefined and regular routes for construction vessels travelling to and from the construction area were determined by the Marine Traffic Impact Assessments (MTIA) conducted for contract P281-Third Runway Reclamation Design Consultancy Services (BMT, 2014) and this MTIA was also referred in the approved 3RS EIA report. The following sub-sections describe the key factors which have already been considered for the travel routes of construction vessels.

#### 5.1.1 Existing Navigation Channel and Marine Traffic

Vessels and barges have been routed into water-spaces where they would have the least impact on existing marine traffic during the construction period. The MTIA has identified the areas of concern with relatively higher density of average daily marine traffic, which included the water-spaces and channels within the Western Harbour, around Tsing Yi and through Ma Wan and Urmston Road. Although Urmston Road does not encounter particularly high incident rates given its traffic density, operationally it is a critical channel for the navigation of ocean going vessels (OGVs).

#### 5.1.2 Restricted Areas, Height Restriction and Speed Limit

Construction and associated vessels' operating license conditions have been taken into account as these may prohibit entry into certain areas. There are restricted areas in the vicinity of HKIA (i.e. HKIAAA for the 3RS, the existing Sha Chau and Lung Kwu Chau Marine Park, the Brothers Marine Park (BMP), the Southwest Lantau Marine Park (SWLMP) and the South Lantau Marine Park (SLMP)) where vessels are not allowed to enter without authorization except for those circumstances as detailed in **Section 5.2.1**. After the NLMP is designated, the construction and associated vessels have to pass through the NLMP when coming / leaving the Works Area. The construction and associated vessels shall minimize their travelling route within the NLMP, adhere to at a 10-knot speed limit (AFCD, n.d.) when passing through the NLMP and not anchor / stopover within the NLMP. The airport height restriction (AHR) limit is another consideration and if a vessel exceeds the AHR requirement, the Marine Department, Civil Aviation Department and AAHK must collectively agree on practical route realignment that does not compromise the safety requirements of aviation and airport operations. In addition, it is vital for all vessel deployments to comply with other navigational restrictions, for example various bridge area restrictions (i.e. Tsing Ma, Kap Shui Mun, Tung Chung, Tsing Yi, etc.) and speed restrictions, for example within the Harbour, etc.

#### 5.1.3 Water Depth

Adequate water depth is a key issue for the determination of marine travel routes. Larger draught marine vessels would be limited from approaching the Works Area from the northwest due to relatively shallow water depth (5.1 – 10 m above Chart Datum). For the construction and associated vessels that require to take the west gate for entry into the Works Area, the vessel captains shall remain alert the relatively shallow water depth at the western waters when travelling from the east and northeastern waters to the south of the Sha Chau and Lung Kwu Chau Marine Park. Vessel captains will be informed of shallow water depth areas along the marine travel routes during the skipper training workshops. Vessel captains will be reminded to regularly check the SONAR or marine map of Hong Kong showing the water depth, in order to remain alert to shallow water areas when navigating to the Works Area with sufficient clearance between the vessel draft

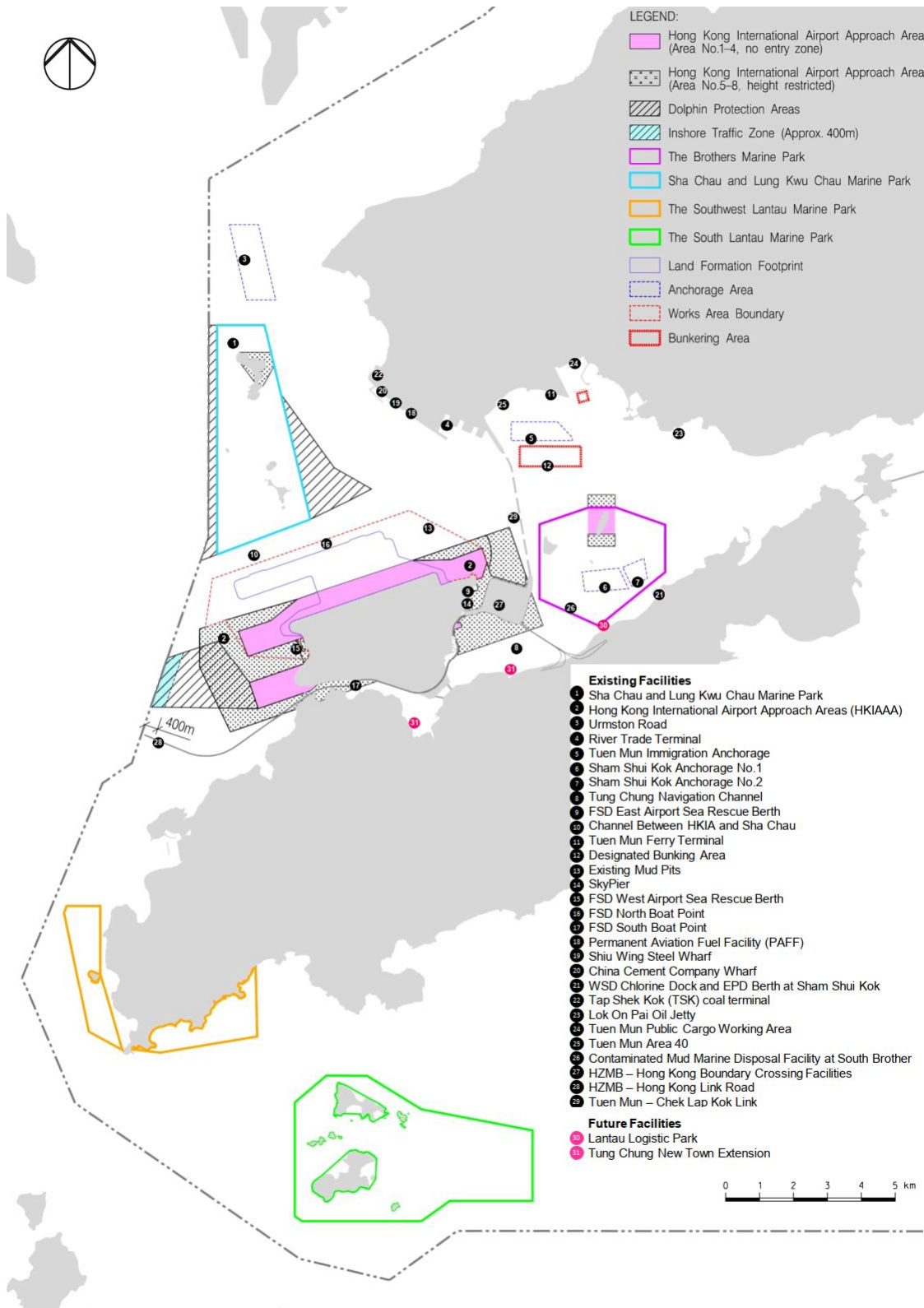
and the seabed. In addition, it is noted that regular hydrographic surveys will be undertaken within the marine Works Area during the project and information on seabed levels will be provided to the on-shore control room (see **Section 8.1.1**) to ensure appropriate information is relayed to vessel operators on changing water depths during the marine works phase.

#### 5.1.4 Other Marine Facilities

The construction vessels are of the types commonly found navigating in Hong Kong waters. The construction vessels are free to navigate through large areas of Hong Kong waters via existing common Hong Kong's navigation channels. The uncommon navigation channel including channel to the north and to the west of the Works Area will be introduced. In-depth examination of critical issues within these navigation channels in Hong Kong have been undertaken during the design of marine travel routes for construction vessels. The local constraints imposed by the Works Area of adjacent projects and other marine facilities, such as anchorage and bunkering areas (**Figures 5-1a, 5-1b and 5-1c**), have also been considered in designing the marine travel routes for construction vessels. Based on the discussion with the Advisory Council on the Environment (ACE) during the EIA stage, AAHK has also proposed to implement additional Dolphin Protection Areas that linked to existing Sha Chau and Lung Kwu Chau Marine Park, and the west of airport island (**Figures 5-1a, 5-1b and 5-1c**). The Dolphin Protection Areas with restriction of entry by construction and associated vessels under normal circumstances will remain during construction phase of the 3RS Project.

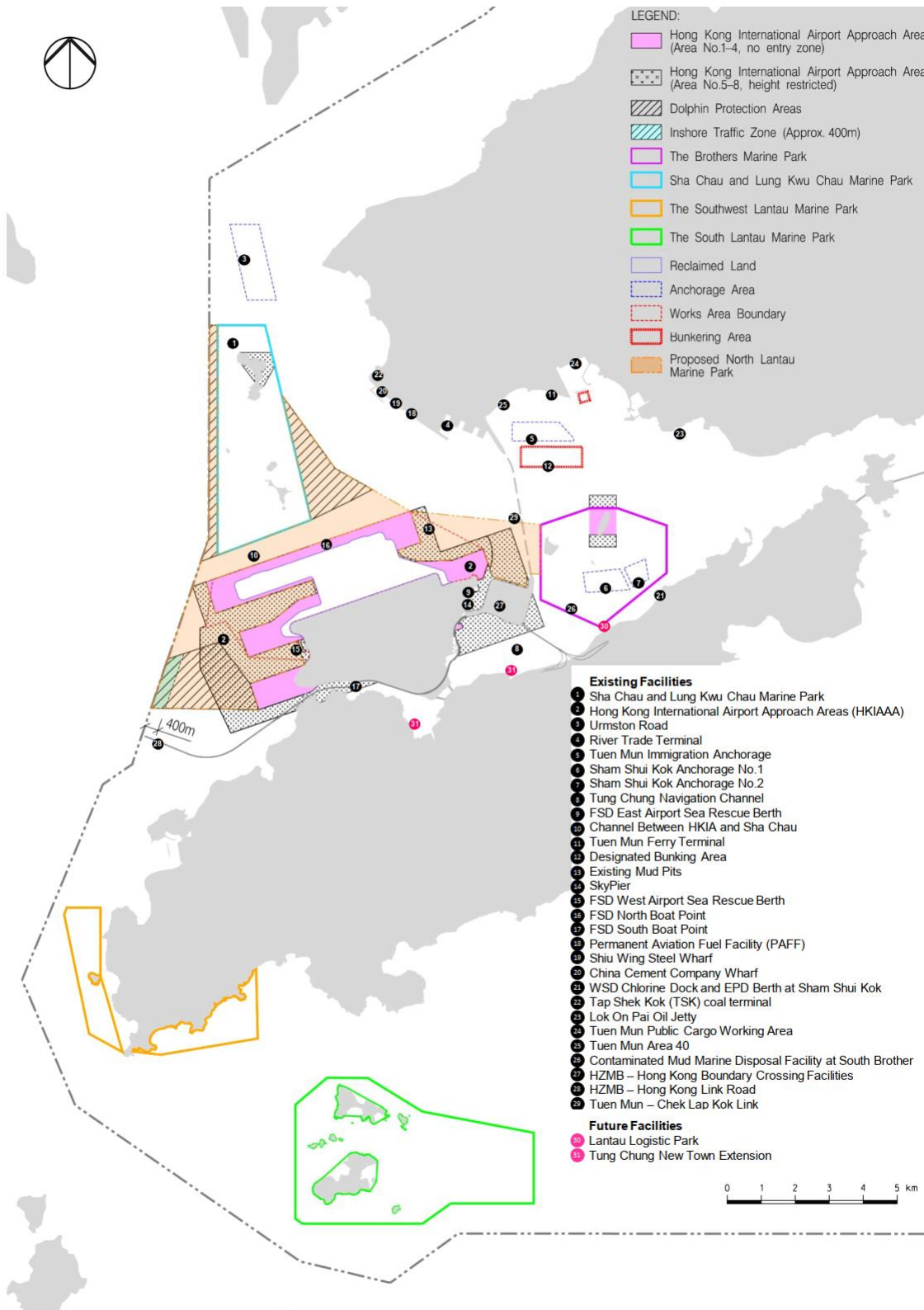
In view of the marine vessels and oil barges that may anchor in anchoring and bunkering areas respectively, the design of the construction vessel travel routes has avoided crossing through these areas due to safety concerns and potential operational impacts.

**Figure 5-1a: Existing and Future Marine Facilities and Dolphin Protection Areas Before Interim Two Runway System (I-2RS)**

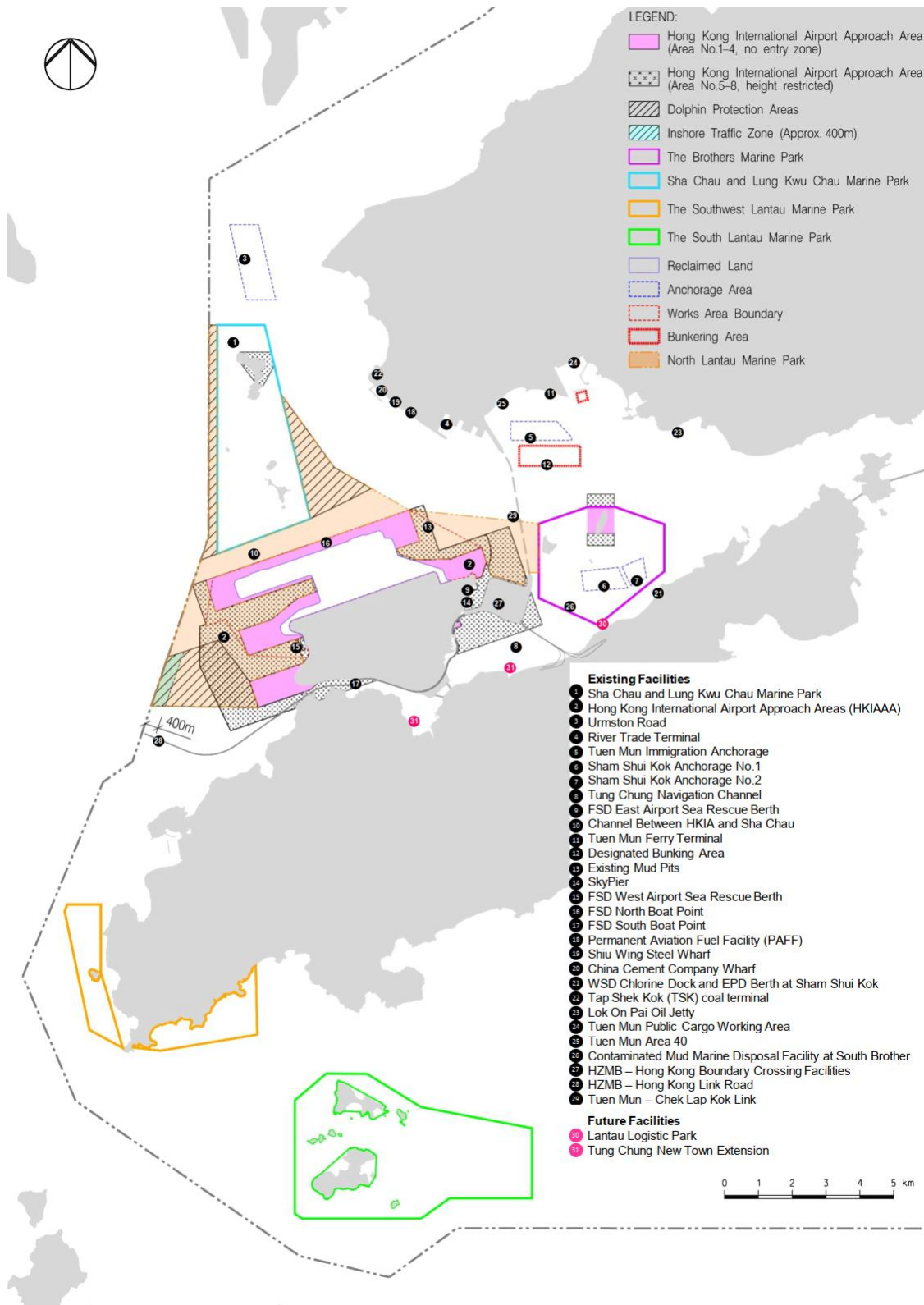




**Figure 5-1b: Existing and Future Marine Facilities and Dolphin Protection Areas After I-2RS and Before Designation of NLMP**



**Figure 5-1c: Existing and Future Marine Facilities and Dolphin Protection Areas After Designation of NLMP**



## 5.2 Design of Marine Travel Route for Construction Vessels

### 5.2.1 General Arrangements for Construction Vessels

The marine travel route for construction vessels was proposed based on best available information. Nevertheless, the use of marine travel routes by construction vessels inside and outside the Works Area would be monitored by the proposed on-shore control room (it will be operated for 24 hours if night time works are required) with the use of tracking system to be installed on all construction and associated vessels (details to be discussed in **Section 8** of this Plan). In addition, the Contractor would prepare rolling vessel plans for the effective management of the numbers and the movements of the construction vessels. The risk of any marine accidents within the Works Area would be minimised with these measures.

Most of the non-self-propelled vessels expected to be deployed during the construction works are barges associated with ground improvement works (**Section 2.4.1**) and seawall construction. Most of these vessels and associated tug boats will enter the Works Area during mobilization periods before commencement of the relevant phases of the construction works. They will then stay and work within the Works Area. The associated tug-boats will be required to use the predefined and regular routes to manoeuvre all non-self-propelled vessels when they travel outside the Works Area.

Self-propelled vessels (**Section 2.4.2**) and vessels delivering materials to and from the project site (**Section 2.4.3**) shall be required to use predefined and regular routes to reduce disturbance to cetaceans due to vessel movements. Specific marine travel routes covering waters outside the Works Area, designed based on the key factors mentioned in **Section 5.1.1 to Section 5.1.4**, are shown in **Figures 5-2, 5-3, 5-4a and 5-4b**. The indicative marine travel routes of construction vessels for delivery of fill materials have been implemented since the commencement of reclamation, from which time the number of construction vessels were kept to a practical minimum. Restrictions on marine travel routes were not applicable to vessels working on HDD pipeline and CLP cable laying, and ground investigation. HDD works involved drilling activity well below the seabed in the bedrock level and only positioning barge was temporarily mobilized (few hours a day) to assist the detection of HDD pipeline alignment. In addition, floating platform was set up just off the Sha Chau Island to support the HDD daylighting and pipelines connection works on land. For the cable laying works, the route of the water jetting barge followed the replacement cable alignment (See **Appendix A**) and works was done at a slow speed along the alignment. As a high volume of construction vessel traffic was not anticipated for these works, no additional restrictions were defined for this marine work effort.

### 5.2.2 Construction Vessels Transit Route

The guiding principle for the development of barge transit routes was to route barges into water-spaces where they would have the least impact on existing marine traffic during the construction period. Areas of particularly busy marine traffic include the navigable waters and channels within the Western Harbour, around Tsing Yi and up through Ma Wan and the Urmston Road area. Urmston Road is a busy operational channel used by broad ranging vessel types including OGV. To avoid interfacing with the existing marine traffic in the aforesaid areas of concern, the bulk of barging volume associated with this project will be directed to arrive at the works site principally from the west and east of the Works Area. This includes those barges entering Hong Kong Waters from the north, which have been routed south of the SCLKCMP. Construction marine traffic is to be minimised through the Urmston Road as far as practicable.

As illustrated in **Figures 5-2, 5-3, 5-4a and 5-4b**, the only transits which have been routed through Hong Kong's busiest waters are those public fill barges (i.e. pelican barges and flat-top barges) to and from Tseung Kwan O/Tuen Mun and marine fill barges (i.e. hopper barges and pelican barges) to and from the South China Sea during the peak period. For the public fill barges,

diverting them south of Lantau to access the Works Area from the west would increase the transit time by over 50%, therefore this traffic volume is accepted to travel through the Western Harbour and Ma Wan areas. As the construction materials and fills may be shipped from the Pearl River Delta, South China Sea, remote provinces of the mainland and other Asian Countries by barge, construction vessels are routed to enter the Works Area through designated site entrances on either side of the land formation footprint primarily to minimise crossing traffic within the narrowed channel north of the HKIA (**Figures 5-2, 5-3, 5-4a and 5-4b**).

The construction materials and fills imported from locations outside Hong Kong may be transported to Hong Kong using OGVs. These OGVs will anchor at suitable anchorage areas for transshipment of the materials from the OGVs to feeder vessels (e.g. pelican barges, derrick lighters) before transport to the Works Area. During peak period, it will be necessary to maximise the use of all suitable gazetted anchorage areas in the waters around the Lantau Island including Sham Shui Kok Anchorage No. 2 (SSKA 2) within the BMP. Using SSKA 2 for transshipment operations would only be considered after other suitable gazetted anchorage areas were exhausted. AAHK has expressed to Marine Department that the use of SSKA 2 would only be the last resort when other suitable gazetted anchorages were not available or unfavourable for transshipment operations through the monthly Marine Management Liaison Group (MMLG) meeting. Environmental Team (ET) will keep the minutes of the MMLG meeting for record. When transshipment operation is to be carried out in SSKA 2, the Contractor is required to implement additional precautionary measures. These include 10-knot speed limit for all feeder vessels within the BMP; avoidance of anchoring (except for emergency purposes) for feeder vessels; using the shortest marine route for entering/leaving the BMP (**Figures 6-1a, 6-1b, 6-1c and 6-1d**); mooring close to the bulk carrier to minimize the gap in between vessels; using closed grab to transfer sand and maintain at a low position for release of sand for OGVs without conveyor; in-situ water quality monitoring; and implementation of Dolphin Exclusion Zone during the transshipment operation. Details on the implementation of these additional precautionary measures will be prepared by the Contractor for review and approval by the ET, Independent Environmental Checker (IEC) and AAHK prior to any transshipment operation at SSKA 2. In addition to the EM&A programme, the ET will also carry out ad-hoc environmental inspections of the transshipment operation within SSKA 2.

### 5.2.3 General Arrangements for Existing and Future Marine Facilities

Construction vessel routes have mostly avoided the existing and future marine facilities shown in **Figures 5-1a, 5-1b and 5-1c**. They have also avoided the existing Marine Parks (i.e. the SCLKCMP, the BMP (except during transshipment operation), SWLMP and SLMP) as well as the Dolphin Protection Areas at the construction stage. After the NLMP is designated, the construction and associated vessels have to pass through the NLMP when coming / leaving the Works Area. The construction and associated vessels shall minimize their travelling route within the NLMP and adhere to at a 10-knot speed limit (AFCD, n.d.) when passing through the NLMP. The route along Urmston Road passes close to the SCLKCMP and this area is a key CWD habitat (Hung, 2015) and a 10-knot speed restriction shall also be applied in regions with high CWD abundance, as determined by referring to a Dolphin Habitat Index that has been established for waters in this area (see **Section 7.3** for details). The marine travel route shall not be changed once approved. Reasonable justifications shall be provided if any changes of the proposed routes are required.

The Pilotage Advisory Committee Paper No. 4/2016 recommended that an inshore traffic zone of about 300m to 400m in width shall be maintained between the boundary of the proposed Marine Parks (SLMP and Soko Islands Marine Park) and the nearby Lantau Channel Traffic Separation Scheme (LCTSS) / Traffic Separation Scheme at South of Lantau (SLTSS) to allow an unrestricted and safe channel for navigation and to minimize potential impacts to marine users. Taking into consideration marine safety, an inshore traffic zone of about 400m in width is proposed between the Hong Kong water boundary and the western part of the Dolphin Protection

Areas to allow the 3RS construction vessels coming / leaving from the southwest to the Works Area. The construction vessels passing through this inshore traffic zone shall be kept not more than 10 knots.

It was noted that existing submarine aviation fuel pipelines were diverted as part of this Project by using HDD method to drill through bedrock from a launching site located at the west of the airport island to a daylighting point on Sheung Sha Chau Island. Construction and associated vessels had to enter the SCLKCMP. As good practice, the construction vessels travelling to and from the work site within the SCLKCMP was minimised their travelling route within the Marine Park as well as adhering to the 10-knot speed limit applicable inside the Marine Park.

#### 5.2.4 Guidelines for Safe Vessel Operations Travelling Outside and Within the Works Area

Apart from transportation boats and those vessels involved in materials delivery, many of the working vessels (e.g. crane barges, derrick barges, tug boats, DCM & PVD barges, spreader pontoons, etc.) will mostly stay within the Works Area. Guidelines for safe vessel operations in the presence of CWDs (**Section 6.3**), including keeping to 10-knot speed limit within the Works Area, will be implemented to minimise any disturbance from such vessels to CWDs.

Vessel captains shall strictly follow all navigation safety requirements and international practices with the help of navigation instruments. Marker buoys and navigation buoys will be used as marine based indicators to help the vessel captains in locating the proper traffic routes under actual situations and during any unexpected incidents. Marine travel routes may be attuned locally for safety reasons, taking into account other marine vessels that may be encountered by construction and associated vessels. The navigation routes may also be affected by natural factors including wind, currents, waves, poor visibility and periodic closure of certain routes (e.g. due to other unusual events). A key commitment is that there shall be no transportation of oversize materials or easily spillable materials such as marine fill during inclement weather.

Construction and associated vessels will not enter the Dolphin Protection Areas as shown in **Figures 5-1a, 5-1b and 5-1c** under normal circumstances. The Dolphin Protection Areas have been implemented during the construction phase, within which there will be effective management controls on construction vessels of the 3RS project.

After the NLMP is designated, there are three areas as shown in **Figure 6-1c**, which are within the works area boundary and are not included in the NLMP namely Area A (located at the western side of the newly reclaimed land between the centre runway and the third runway); Area B (located at the eastern side of newly reclaimed land between the centre runway and the third runway) and Area C (located at Fire Services Department West Airport Sea Rescue Berth). When the construction and associated vessels travel through these three areas outside the marine park, the requirements of Marine Parks Ordinance do not apply.

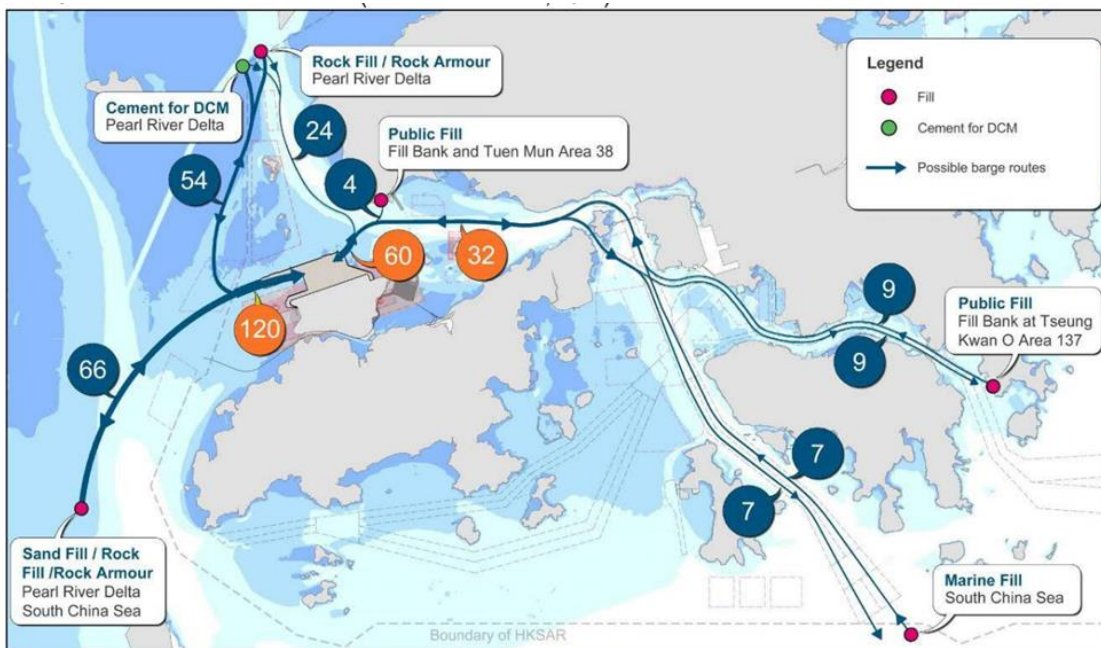
Within the Works Area, it is expected that different marine travel routes will be required for accessing different Works Area from various piers for each construction contracts. Material trucks/vehicles will use available piers or landing points offsite e.g. Tuen Mun Public Cargo Working Area, Tuen Mun Area 40 and River Trade Terminal etc. for accessing the Works Area by ro-ro barges from time to time. In order to reduce disturbance to cetaceans due to vessel movements, construction vessel shall adhere to the following principles for the general routes for construction vessels travelling within the Works Area:

- All construction and associated vessels shall only access the Works Area through the west gate or east gate;
- All construction and associated vessels shall follow the routes with practicable minimum distance from the entrance of the Works Area to the designated works site;

- Main routes shall be used after entering the Works Area. Branches routes shall be minimised as far as practicable;
- Sudden course changes shall be avoided to reduce disturbance to cetaceans; and
- All vessels shall adhere to the speed limit of 10-knot or below within Works Area.

Vessel captains will be informed of the above principles for the general routes for construction vessels within the Works Area during the Skipper Training Workshops.

**Figure 5-2: Indicative Marine Travel Route with Forecast Construction Traffic Movements during Peak Period per Day After Commencement of Reclamation Before I-2RS (modified from BMT, 2014)**



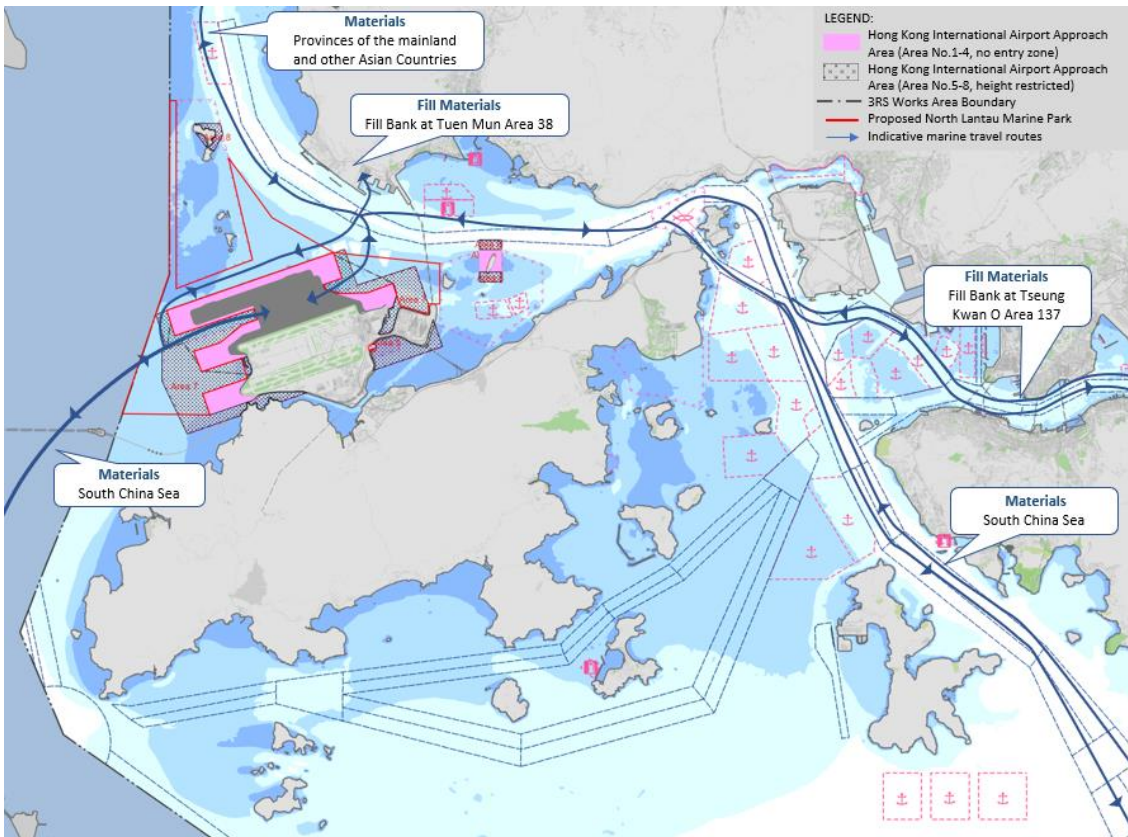
Note: The numbers highlighted in the figure indicate the forecasted daily transits of vessels

**Figure 5-3: Indicative Marine Travel Route with Forecast Construction Traffic Movements on Average per Day After Commencement of Reclamation Before I-2RS (modified from BMT, 2014)**

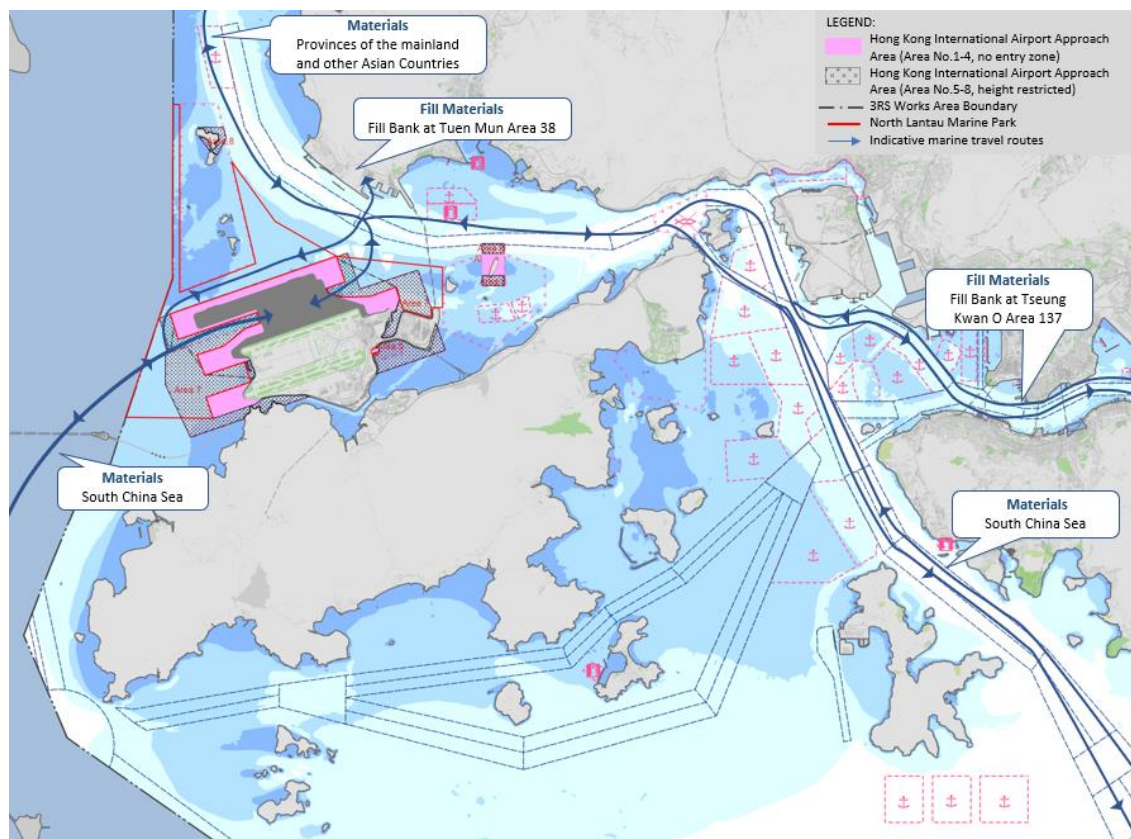


Note: The numbers highlighted in the figure indicate the forecasted daily transits of vessels

**Figure 5-4a: Indicative Marine Travel Route After I-2RS and Before Designation of NLMP**



**Figure 5-4b: Indicative Marine Travel Route After Designation of NLMP**



### 5.2.5 Contingency Arrangements

Contingency plans have been developed for periods of disruption, such as typhoons, strong monsoon signals, thunderstorms, black rain alerts, and accident incidents upon commencement of land formation works. Respective plans will need to be developed by relevant parties, but those operating construction and associated vessels may be expected to adhere to the general principles outlined below.

The typhoon arrangements will require all work barges/craft to leave the Works Area on or before Typhoon Signal no. 3 is hoisted.

It is anticipated that the main designated typhoon shelters for works vessels will be the Tuen Mun Typhoon Shelter and the Hei Ling Chau Typhoon Shelter. Tug & tow / crane barge will leave from the Works Area and travel via Ma Wan Fairway to the Hei Ling Chau Typhoon Shelters on or before the Typhoon Signal 3 is raised. However, due to the large numbers of works vessels involved in the construction of the reclamation, it is possible that typhoon shelters within Hong Kong waters will not be able to cater for this level of demand. Works vessels will also have to shelter within deep water space within Mainland China providing the nearest sheltered site.

Procedures have been developed by all marine works Contractors to allow for a phased departure of works craft from the site in the event of a typhoon, so that navigation channels do not become overcrowded and to avoid obstructing the passage of other vessels on or before the Typhoon Signal no. 3 is hoisted. **Figure 5-5** presents potential routes to be taken by works vessels during typhoons.



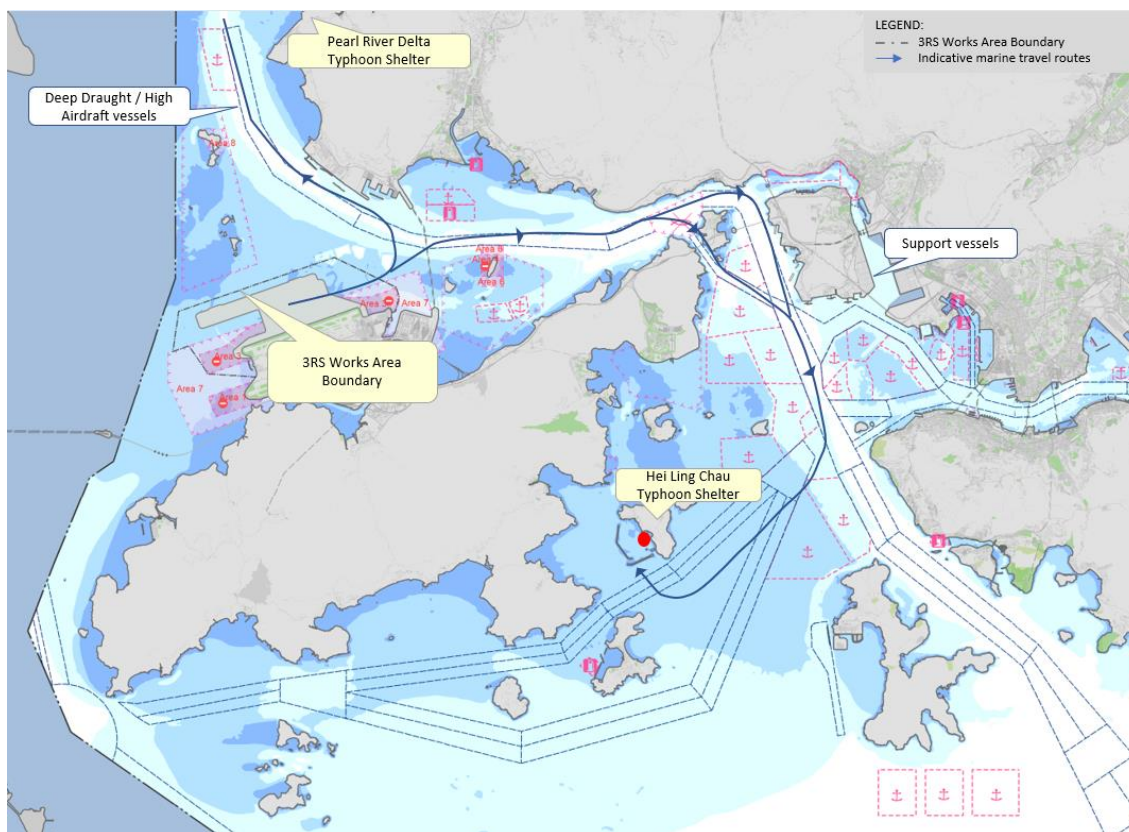
For example:

- Deep draught / high airdraft vessels shall be first to leave the site when the Typhoon Signal no. 3 is anticipated to be hoisted by the Hong Kong Observatory within 2-4 hours.
- Tug & Tow vessels shall then leave the site after these deep draft vessels have left.
- Smaller, more manoeuvrable support vessels shall then leave the site when the Typhoon Signal no. 3 is hoisted.

In case of marine accidents (e.g. collision, grounding, search and rescue including aeronautical incident) that may occur during the construction stage, actions will be required to manage vessels during these events and re-routing, control and regulation of marine traffic may be required. It is anticipated that this response will be similar in manner to the response to such incidences elsewhere within Hong Kong waters. The precautionary / mitigation measures of potential oil spill can be referred to in the Spill Response Plan (SRP) which provides the guidelines for setup of contract-specific SRPs by Contractors.

Further to Fire Services Department's comment, emergency access points shall be allowed from the north side to the Works Area. These access points are only allowed for marine police and fire boat for marine rescue purposes only.

**Figure 5-5: Potential Routes to Typhoon Shelters**



## 6 Skipper Training and Guidelines for Safe Vessel Operations in the Presence of the CWDs

### 6.1 Impacts on CWDs and Precautionary Measures

As assessed in the approved EIA report, construction vessels will be largely slow-moving, however the activities they will be undertaking may cause physical disturbance and can cause noise disturbance to CWDs. Noise from the slow moving vessels themselves is not expected to have a serious impact on CWD behavior and was considered of low impact significance in the EIA. Also, the risk of construction vessel collisions with CWDs was also considered to represent a low impact significance in the EIA.

Even so, skipper training and vessel controls have been recommended as precautionary measures in the approved EIA report to further minimize any potential impacts. A speed limit of 10-knot shall be strictly observed for construction vessels within the areas with high CWD density.

### 6.2 Skipper Training

The ET shall provide training to vessel skippers to ensure vessel operations pose minimal risks to CWDs. The training shall include briefings on predefined routes, general education on local cetaceans, guidelines for avoiding adverse water quality impact, the required environmental practices / measures while operating construction and associated vessels under the Project, and guidelines for operating vessels safely in the presence of CWDs (**Section 6.3**). The ET shall schedule the training with individual Contractors and ensure all marine vessel skippers working on the Project are adequately briefed and trained prior to marine construction or prior to skippers commencing work operating vessels in Works Area. The overall principles for construction vessels travel within / outside the Works Area are shown in **Figures 6-1a, 6-1b, 6-1c and 6-1d**. The no entry zones which defined as Marine Parks, Dolphin Protection Areas, and 10-knot speed limit areas within / outside the Works Area are shown in **Figure 6-1d**. The training materials will be prepared by ET and endorsed by the CWD specialist, and all material used shall be updated time to time during the construction of the project. The ET will conduct the training and refresher courses as and when required (e.g. in the event that the regular travel route is updated along as work progresses), to ensure that the vessels shall be used in a dolphin-friendly manner. The vessel captains training record will be reported in the Monthly EM&A Report. All relevant training records and training materials shall be kept by the ET and made available to IEC, AAHK and EPD upon request.

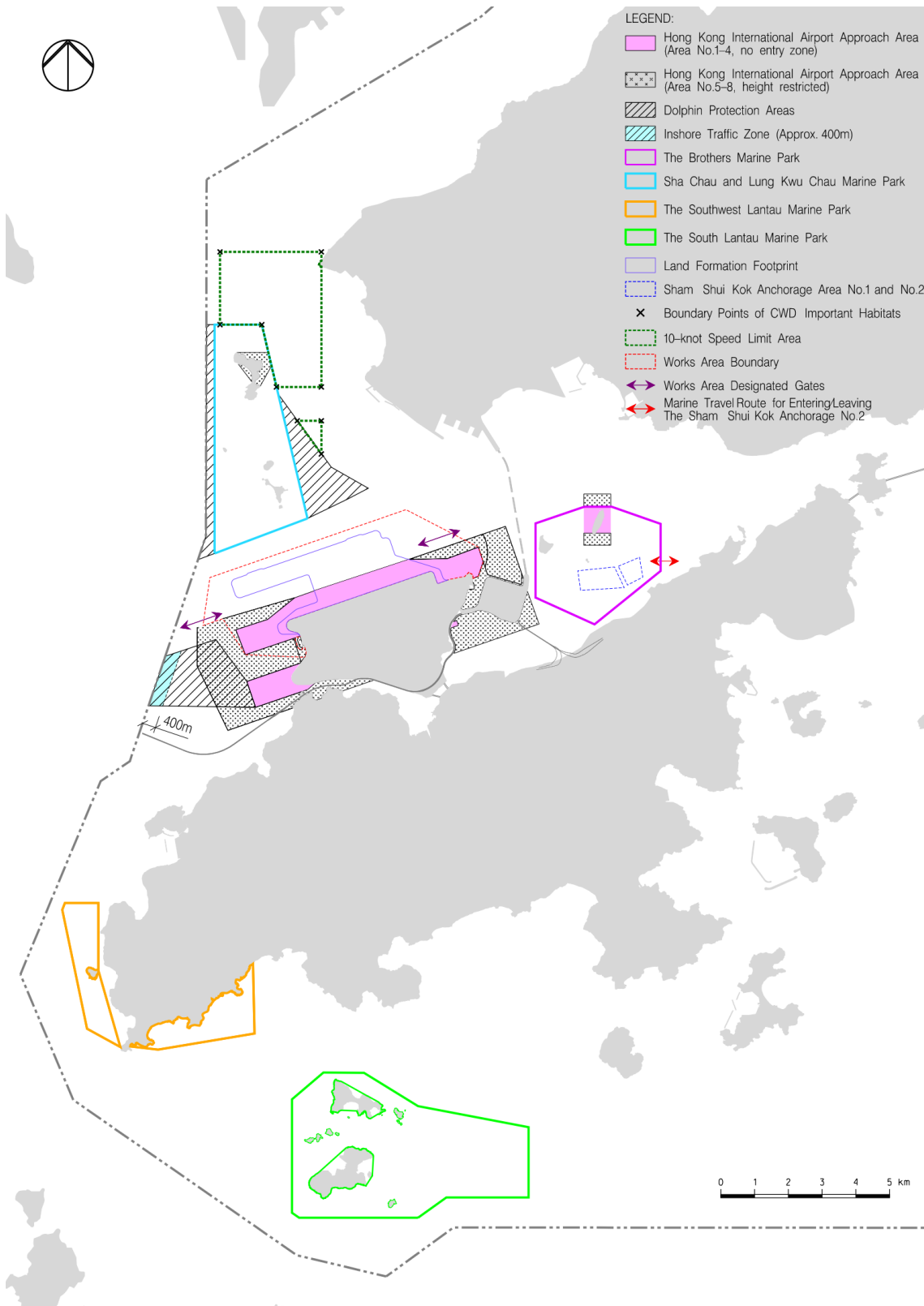
### 6.3 Guidelines for Safe Vessel Operations in the Presence of the CWDs

One of the major human-caused threats to CWDs is injury / death due to marine vessel collision. Locations with frequent CWD sightings near the proposed vessel routes shall be traversed with more caution to avoid impact on CWDs. Reference may be made to the “Code of Conduct for Dolphin Watching Activities” published by Agriculture, Fisheries and Conservation Department (AFCD) and other relevant sources. A code of conduct for construction and associated vessels in the presence of CWDs is provided in **Appendix C**. The following measures are also considered to be helpful to minimise the chance of a vessel striking CWDs and will be covered in training sessions:

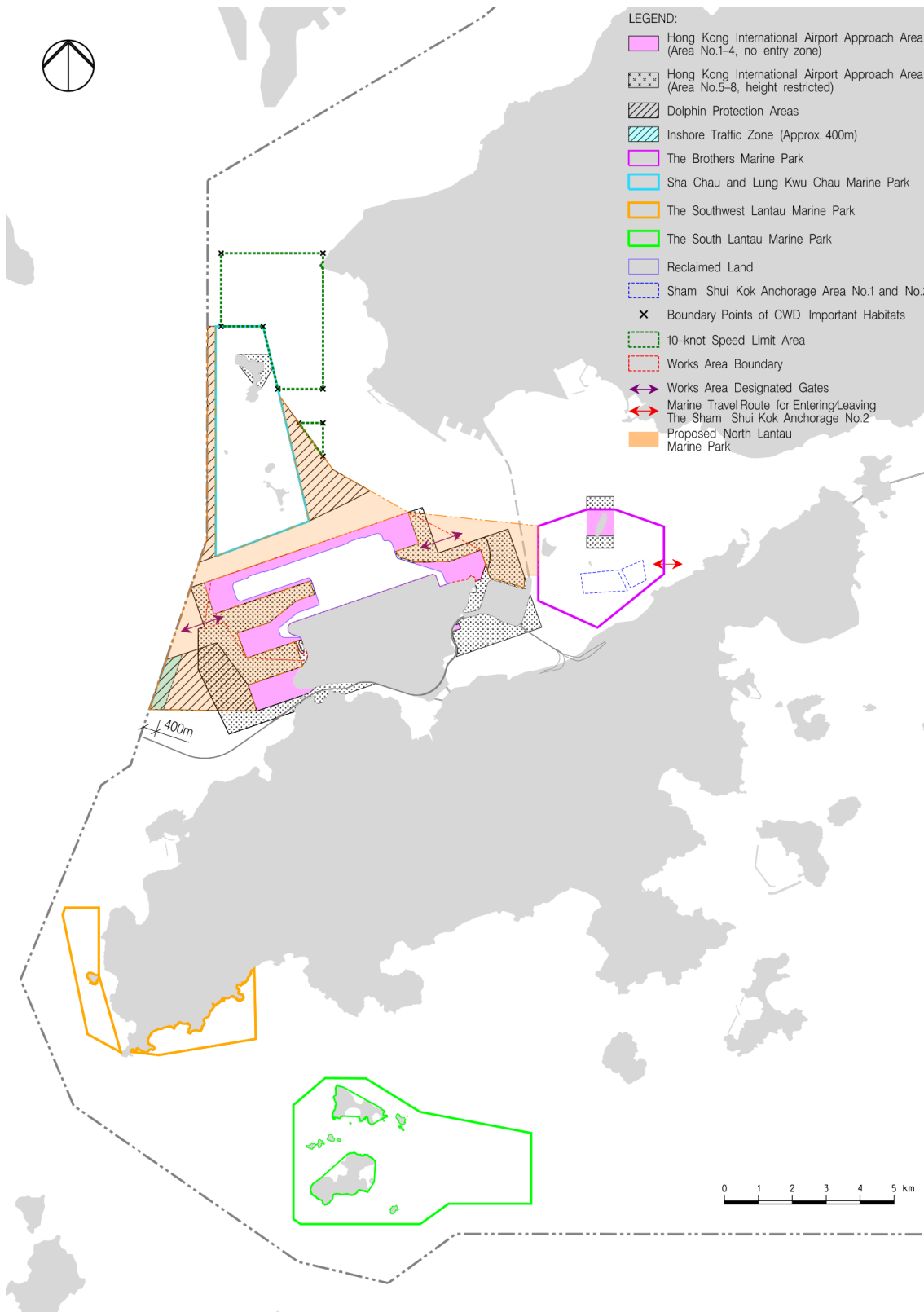
- All vessels will enter the Works Area through designated site entrances, as shown in **Figures 6-1a, 6-1b, 6-1c and 6-1d**;

- All vessels will travel at a speed no greater than 10 knots in the Works Area, which will be demarcated by floating booms and yellow marker buoys;
- The vessel captain shall always remain a vigilant for the presence of CWDs and make sure they slow down prior to passing known CWD hotspots, and take actions to avoid disturbance to or collisions with CWDs;
- The construction and associated vessels shall strictly observe a speed limit of 10-knot within CWD hotspot areas (also known as ‘highly critical’ dolphin habitats’ in **Figures 7-5a, 7-5b and 7-5c**);
- Construction and associated vessels shall avoid traversing through existing Marine Parks (including the SCLKCMP, the BMP, SWLMP and SLMP), except for the case of the SCLKCMP in association with works on the diversion of aviation fuel pipeline and the temporary works such as setting up the generator at the Sha Chau, Sheung Sha Chau and Lung Kwu Chau for the cable diversion work and during transshipment operation at SSKA 2;
- Construction and associated vessels shall not anchor or stopover within the existing Marine Parks (including the SCLKCMP, the BMP, SWLMP, SLMP), except for the case of the SCLKCMP in association with works on the diversion of aviation fuel pipeline with AFCD’s authorization and the temporary works such as setting up the generator at the Sha Chau, Sheung Sha Chau and Lung Kwu Chau for the cable diversion work and during transshipment operation at SSKA 2;
- After designation of NLMP, the construction and associated vessels have to pass through the NLMP when coming / leaving the Works Area. The construction and associated vessels shall minimize their travelling route within the NLMP, adhere to at a 10-knot speed limit (AFCD, n.d) when passing through the NLMP and not anchor / stopover within the NLMP; and
- Construction and associated vessels shall not enter the Dolphin Protection Areas (see **Figures 5-1a, 5-1b and 5-1c**) under normal circumstances.

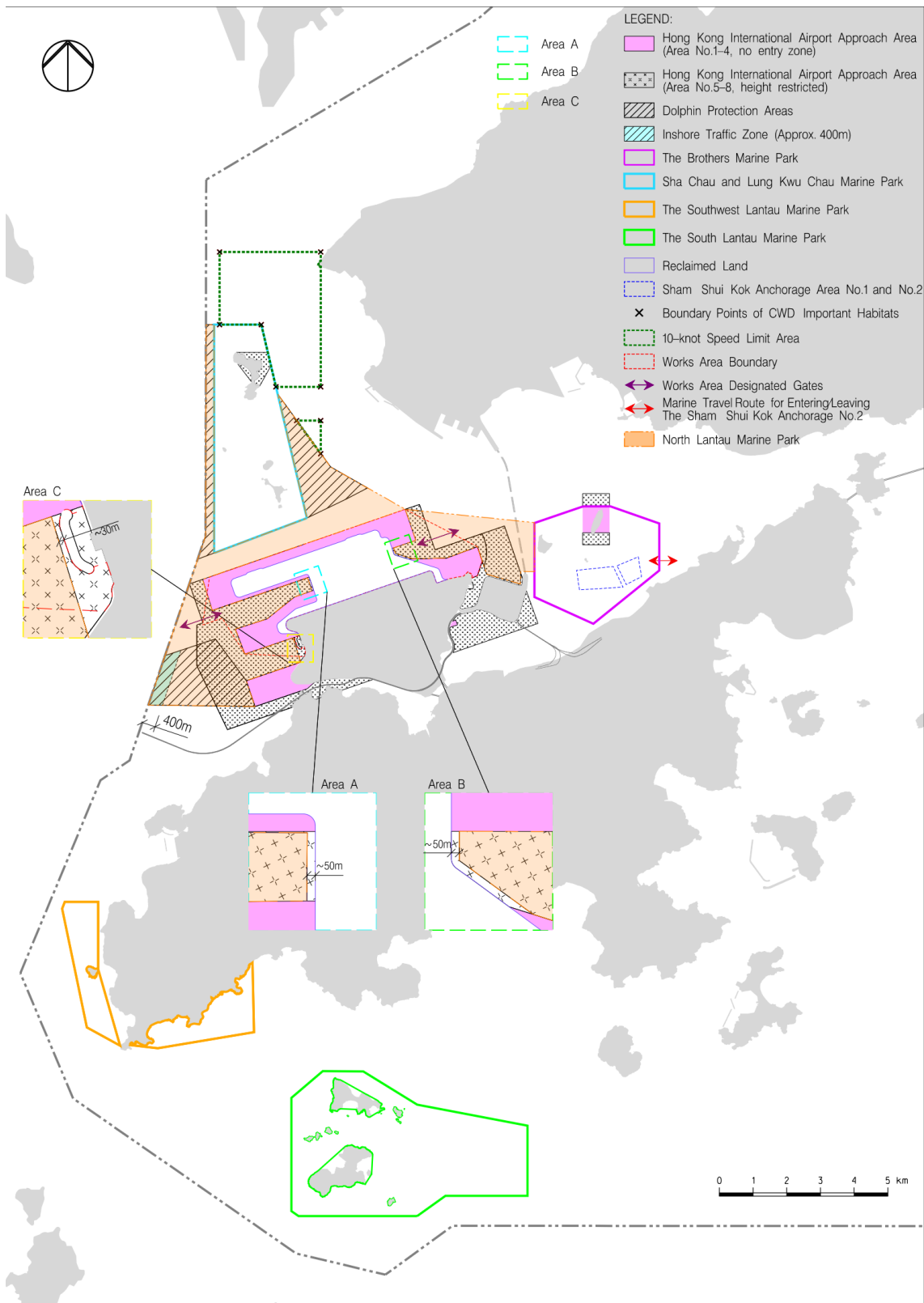
**Figure 6-1a: Overall Principles for Construction Vessels Travel Within / Outside the Works Area Before I-2RS**



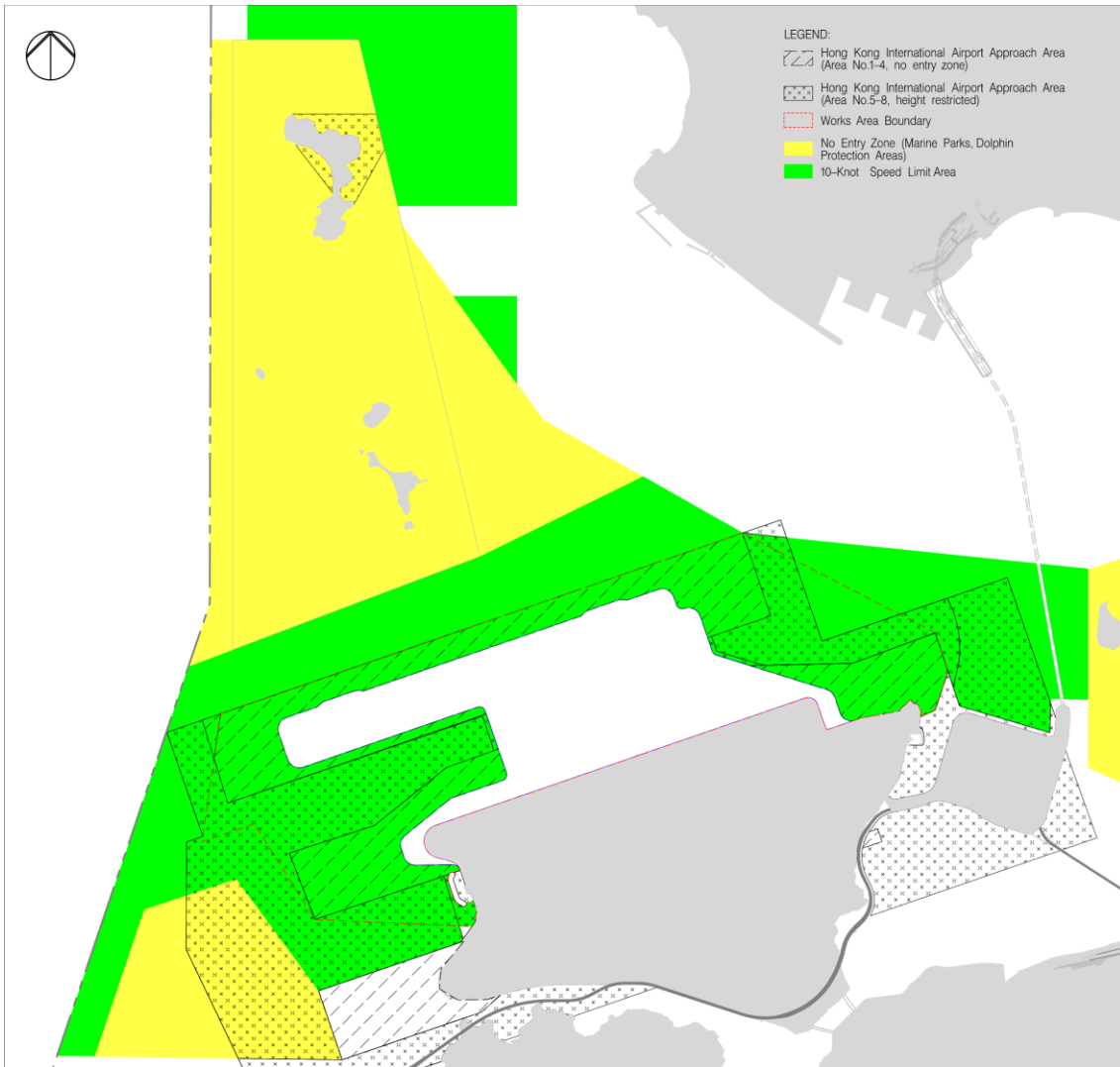
**Figure 6-1b: Overall Principles for Construction Vessels Travel Within / Outside the Works Area After I-2RS and Before Designation of NLMP**



**Figure 6-1c: Overall Principles for Construction Vessels Travel Within / Outside the Works Area After Designation of NLMP**



**Figure 6-1d: No Entry Zone and 10-knot Speed Limit Area for Construction Vessels Travel Within / Outside the Works Area After Designation of NLMP**



## 7 Speed Limit of 10-knot for Construction Vessels within Works Area & CWD Hotspots

### 7.1 Works Area

Apart from transportation boats and those vessels involved in materials delivery, many of the working vessels (e.g. crane barges, derrick barges, tug boats, DCM & PVD barges, spreader pontoons, etc.) will mostly stay within the Works Area. However, all construction and associated vessels shall adhere to the speed limit of 10-knot or below within Works Area as shown in **Figures 6-1a, 6-1b, 6-1c and 6-1d** to minimise any disturbance from such vessels to CWDs.

### 7.2 Dolphin Protection Areas

According to the approved EIA report, construction vessel impacts were evaluated as of low impact significance to CWDs. However, mitigation measures including speed limits of 10-knot in CWD hotspots (this section) and skipper trainings (refer to **Section 6.2**) are recommended as precautionary measures. Speed limit of 10-knot for construction vessels appears to be effective in protecting CWDs from vessel collisions and acoustic disturbance. In addition, the Dolphin Protection Areas (see **Figures 7-5a, 7-5b and 7-5c**) have been proposed during the construction phase in response to ACE comments during the EIA approval process, within which there will be effective management controls on construction vessels of the 3RS project. In order to avoid disturbance to the Marine Parks, I proposed routes of construction vessels have been designed to avoid construction and associated vessels travelling across existing Marine Parks (i.e. the SCLKCMP, the BMP (except during transshipment operation), SWLMP and SLMP) Also, after the NLMP designation, the construction and associated vessels have to pass through the NLMP when coming / leaving the Works Area. The construction and associated vessels shall minimize their travelling route within the NLMP, adhere to at a 10-knot speed limit (ACFD, n.d.) when passing through the NLMP and not anchor or stopover within the NLMP.

### 7.3 Chinese White Dolphin “Hotspot” Areas

As discussed in **Section 5.2**, the proposed marine travel routes for construction vessels have mostly avoided the proposed SLMP in the western waters as well as the Dolphin Protection Areas. The proposed marine travel routes have also avoided the Dolphin Protection Areas (see **Figures 7-5a, 7-5b and 7-5c**) proposed by AAHK in response to ACE comments during the EIA approval process. However, given that the route along Urmston Road to the northeast of SCLKCMP is a CWD key habitat, a 10-knot speed restriction will be imposed on the construction and associated vessels traversing areas with high CWD abundance (i.e. ‘highly critical’ dolphin habitats in **Figures 7-5a, 7-5b and 7-5c**).

In order to determine the area to which speed limits of construction and associated vessels shall be applied for reducing impacts on CWDs, data from the AFCD long-term surveys (see Hung 2014 for a description of these data) have been evaluated to make the best possible determination of the relative value of each 1 x 1 km grid for use in this exercise. The latest available data including the recent marine mammal monitoring report (Hung, 2023) has been taken into account for developing the dolphin habitat index.

It was decided that, in order to avoid potential biases from any single measure, a matrix of four measures of dolphin use of each grid would be used. For each 1 x 1 km grid in the potential HSF route area, four factors have been considered:



1. Current density by DPSE, i.e. the number of CWDs per 100 units of survey effort in the 1 x 1 km grid (**Figure 7-1**; from Hung, 2023)
2. Historical density by DPSE (**Figure 7-2**; from Hung, 2014)
3. Habitat rating (**Figure 7-3**; from Hung, 2014)
4. 50% core area usage by CWDs (**Figure 7-4**; from Hung, 2014)

All of these four factors are based on dolphin numbers per unit effort, but including data on the four factors helps to ensure the analysis has broad temporal and biological relevance, and minimizes impacts of potential data anomalies from using just a single factor. A matrix of the relevant data was compiled. For each 1 x 1 km grid, there are four values presented, corresponding to the four factors listed above, and for each one evaluated as “Low”, “Medium” or “High” (note that these are subjective descriptive terms, though objective quantitative values for building the matrix were used). For densities (both current and historical), the corresponding values for “Low” were 0.0-20.0, 20.1-40.0 for “Medium”, and 40.1 or above for “High”. For habitat ratings, the corresponding values for “Low” were 0-10, 11-20 for “Medium”, and 21 or above for “High”. For 50% core areas, the corresponding values for “Low” were 0-10, 11-30 for “Medium”, and 31 or above for “High”. Relevant raw data are presented in detail in Hung (2014) and Hung (2023). The dolphin habitat index is then developed for each grid as shown in **Figures 7-5a, 7-5b and 7-5c**.

**Table 7-1: Criteria for each 1 km<sup>2</sup> grid in defining the dolphin habitat index, based on the ranking of four factors (i.e. current density by DPSE, historical density by DPSE, habitat rating and 50% core area usage by CWDs)**

Dolphin habitat index	Criteria
Least Critical	<ul style="list-style-type: none"> <li>• 3 “Low”; or</li> <li>• 4 “Low”</li> </ul>
Less Critical	<ul style="list-style-type: none"> <li>• 2 “Medium” and 2 “Low”; or</li> <li>• 1 “High” and 1 “Medium and ” 2 “Low”</li> </ul>
Moderately Critical	<ul style="list-style-type: none"> <li>• 2 “High” and 1 “Medium”; or</li> <li>• 2 “High” and 2 “Low”; or</li> <li>• 1 “High” and 2 “Medium”; or</li> <li>• 3 “Medium”</li> </ul>
Highly Critical	<ul style="list-style-type: none"> <li>• 3 “High”; or</li> <li>• 4 “High”</li> </ul>

The resulting matrix (see **Figures 7-5a, 7-5b and 7-5c**) identifies highly critical areas of CWD habitat to the northeast of SCLKCMP which are delineated by boundary points A – J with GPS coordinates. Speed limits within these areas will be limited to 10 knots or less and this will be communicated to construction vessel captains during the skipper trainings. However, there may be exceptional cases that the 10-knot speed limit could be relaxed for contingency arrangements (e.g. during typhoon, adverse weather conditions) and for safety or emergency purposes.

The CWD “Hotspot” areas will be reviewed annually based on the AFCD Marine Mammal Monitoring Report.

**Figure 7-1: Current density of Chinese White Dolphins with corrected survey effort per km<sup>2</sup> in waters around Lantau Island between January – December 2022 (number within grids represent “DPSE” = no. of dolphins per 100 units of survey effort; from Hung, 2023). In the dolphin habitat index developed for this plan, DPSE of 0.0 – 20.0 is rated as “Low”, 20.1 – 40.0 as “Medium” and 40.1 or above as “High”.**

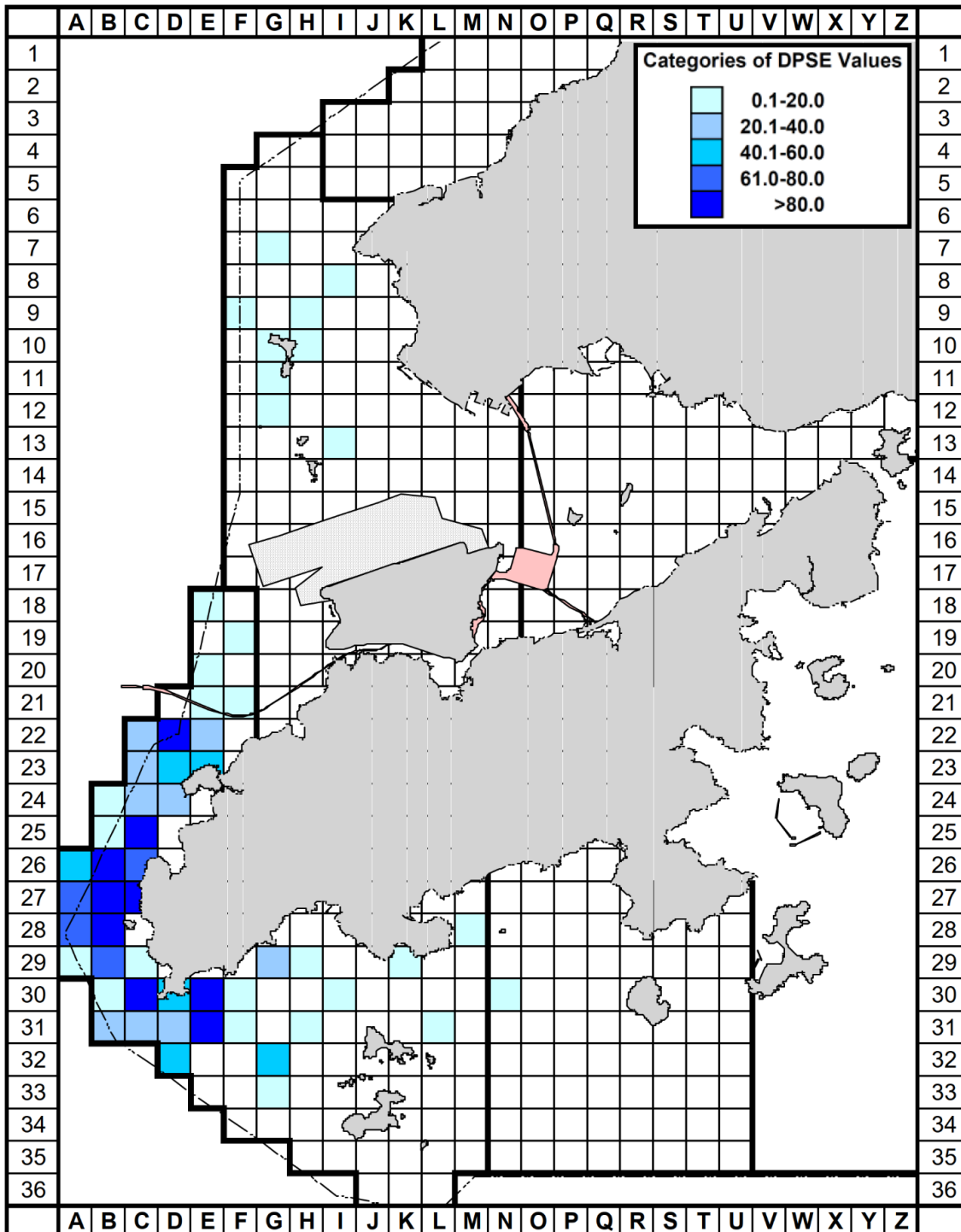


Figure 7-2: Historical density of Chinese White Dolphins with correct survey effort per km<sup>2</sup> in waters around Lantau Island during 2001 – 2012 (numbers within grids represent “DPSE” = no. of dolphins per 100 units of survey effort; from Hung, 2014). In the dolphin habitat index developed for this plan, DPSE of 0.0 – 20.0 is rated as “Low”, 20.1 – 40.0 as “Medium” and 40.1 or above as “High”

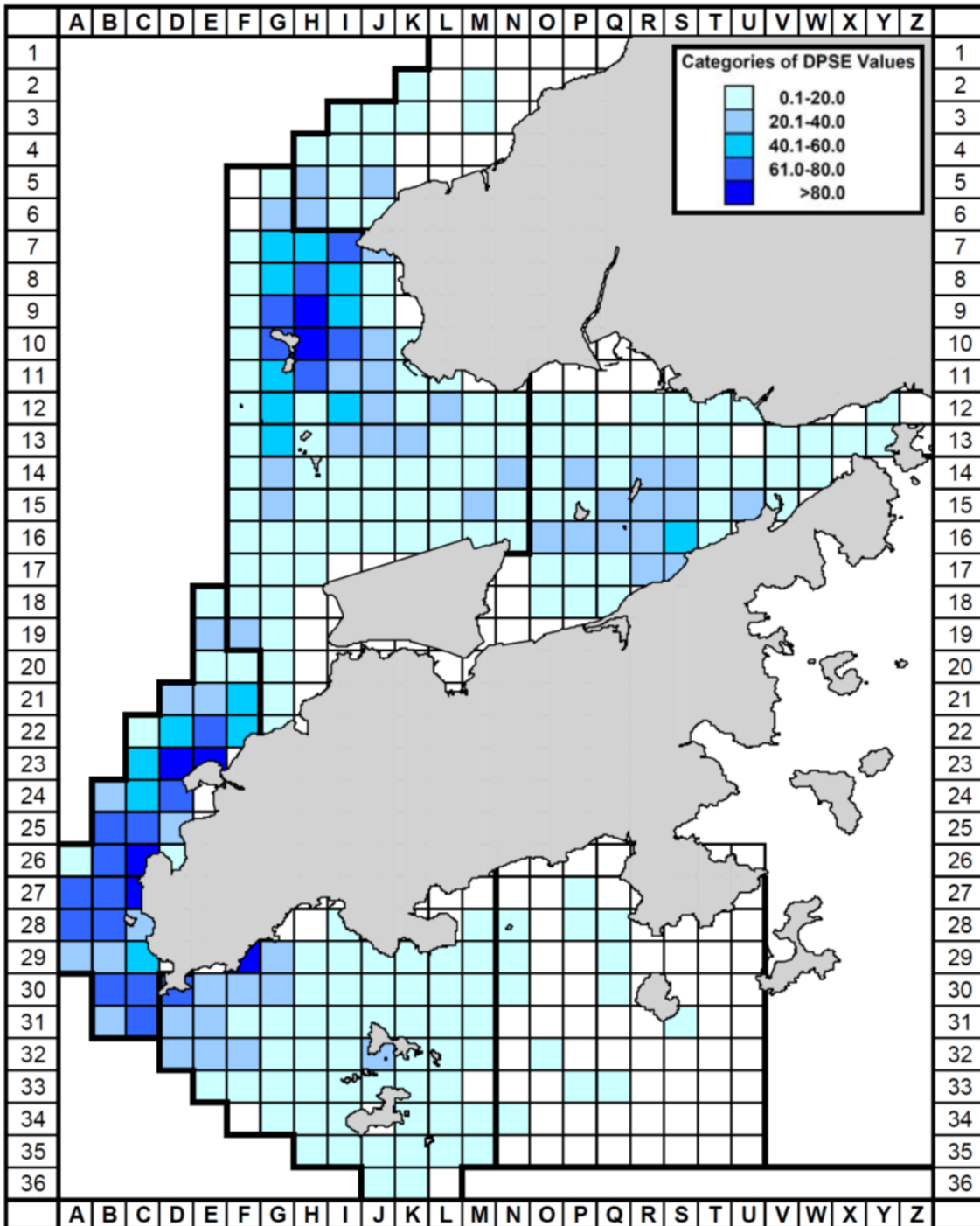


Figure 7-3: Habitat rating of Chinese White Dolphins in Hong Kong using quantitative habitat use information collected during 2001 – 2012 (number with grids represents the sum of scores totalled from 10 selection criteria; from Hung, 2014). In the dolphin habitat index developed for this plan, habitat rating of 0 – 10 is rated as “Low”, 11 – 20 as “Medium”, and 21 or above as “High”

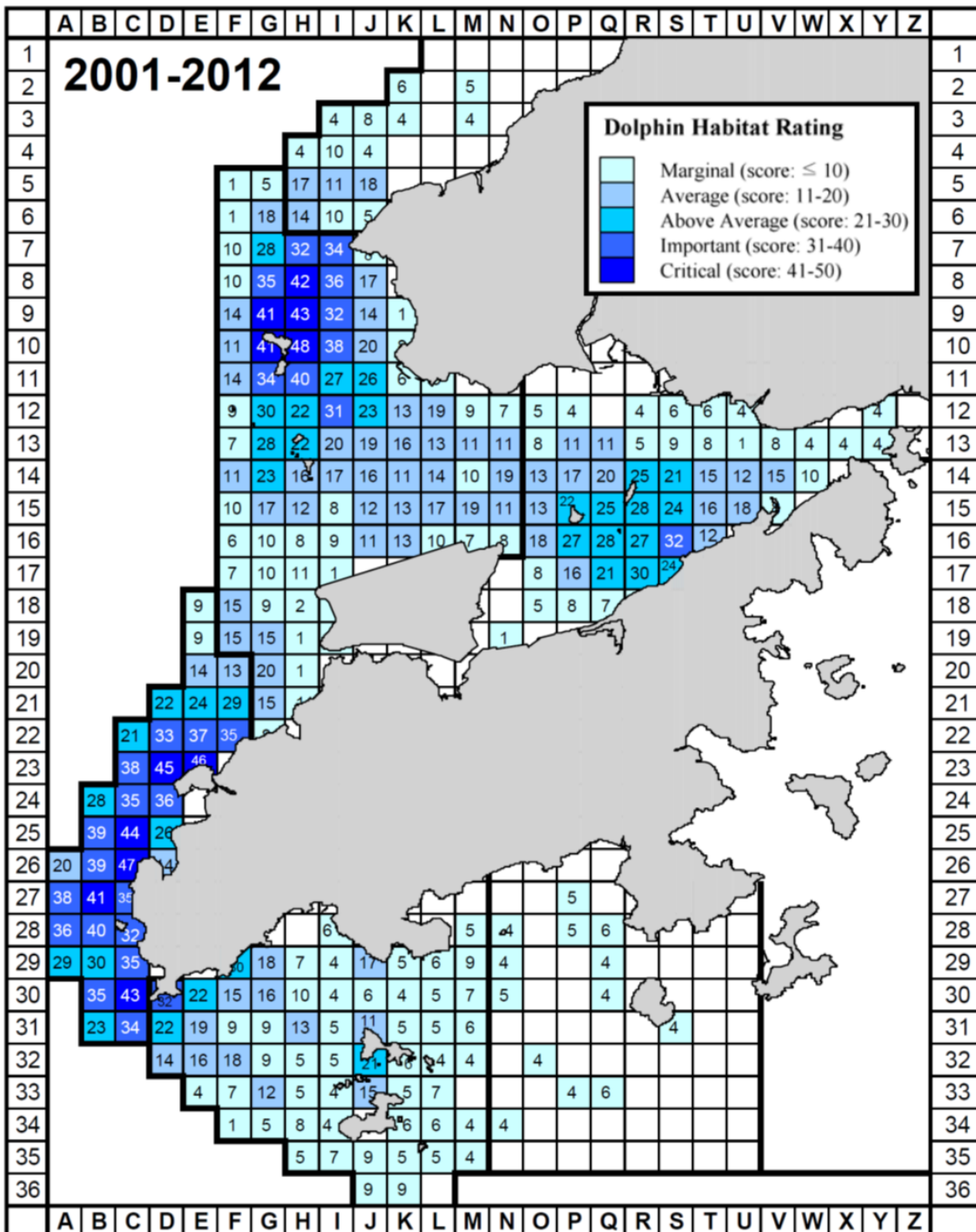


Figure 7-4: Number of individual Chinese White Dolphins with their 50% utilization distribution (UD) core areas overlapped with each 1 km<sup>2</sup> grid in waters around Lantau Island from 2001 – 2012 (Hung, 2014). In the dolphin habitat index developed for this plan, 50% core area of 0-10 is rated as “Low”, 11-30 as “Medium”, and 31 or above as “High”

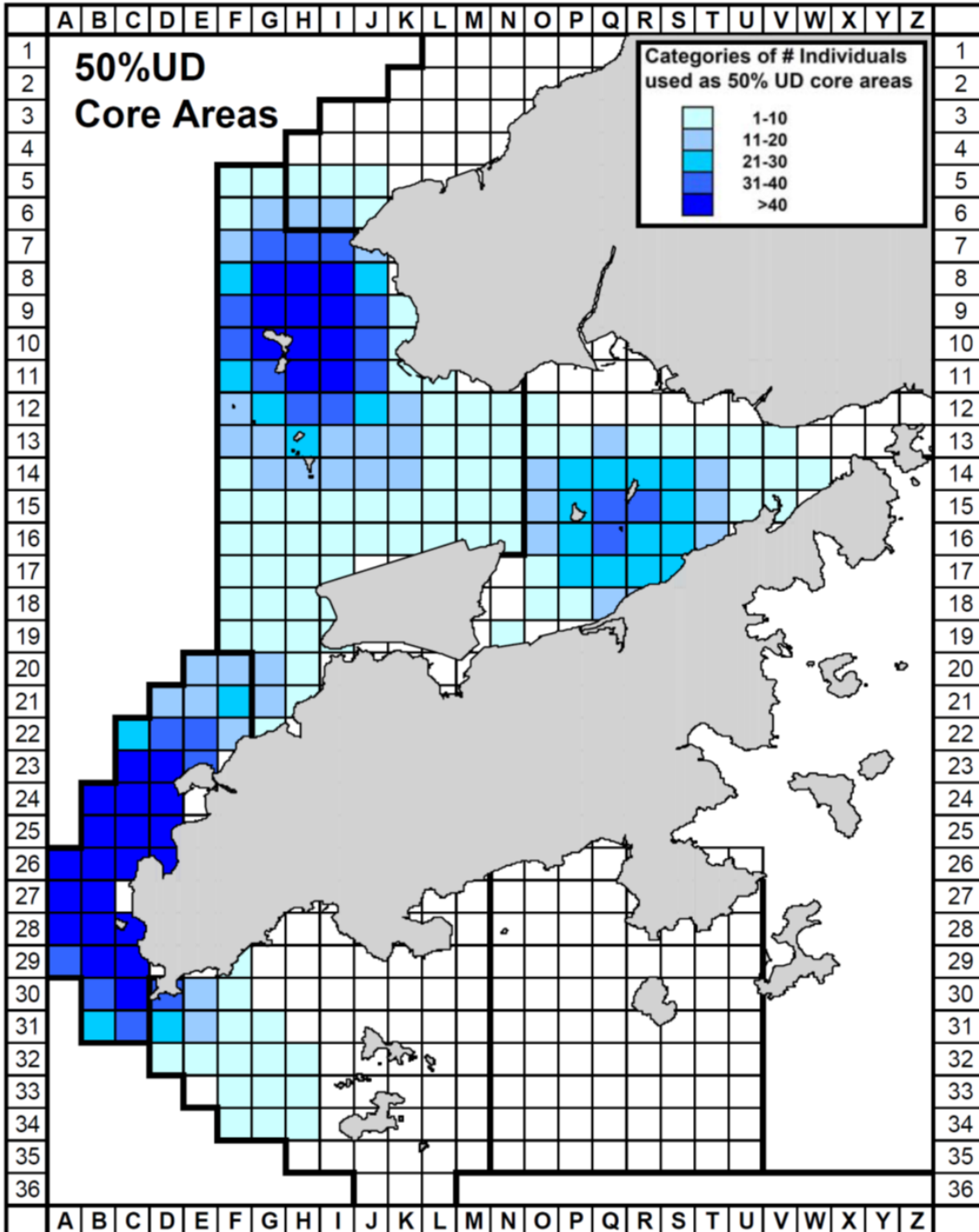


Figure 7-5a: Dolphin Habitat Index and Marine Travel Routes Before I-2RS

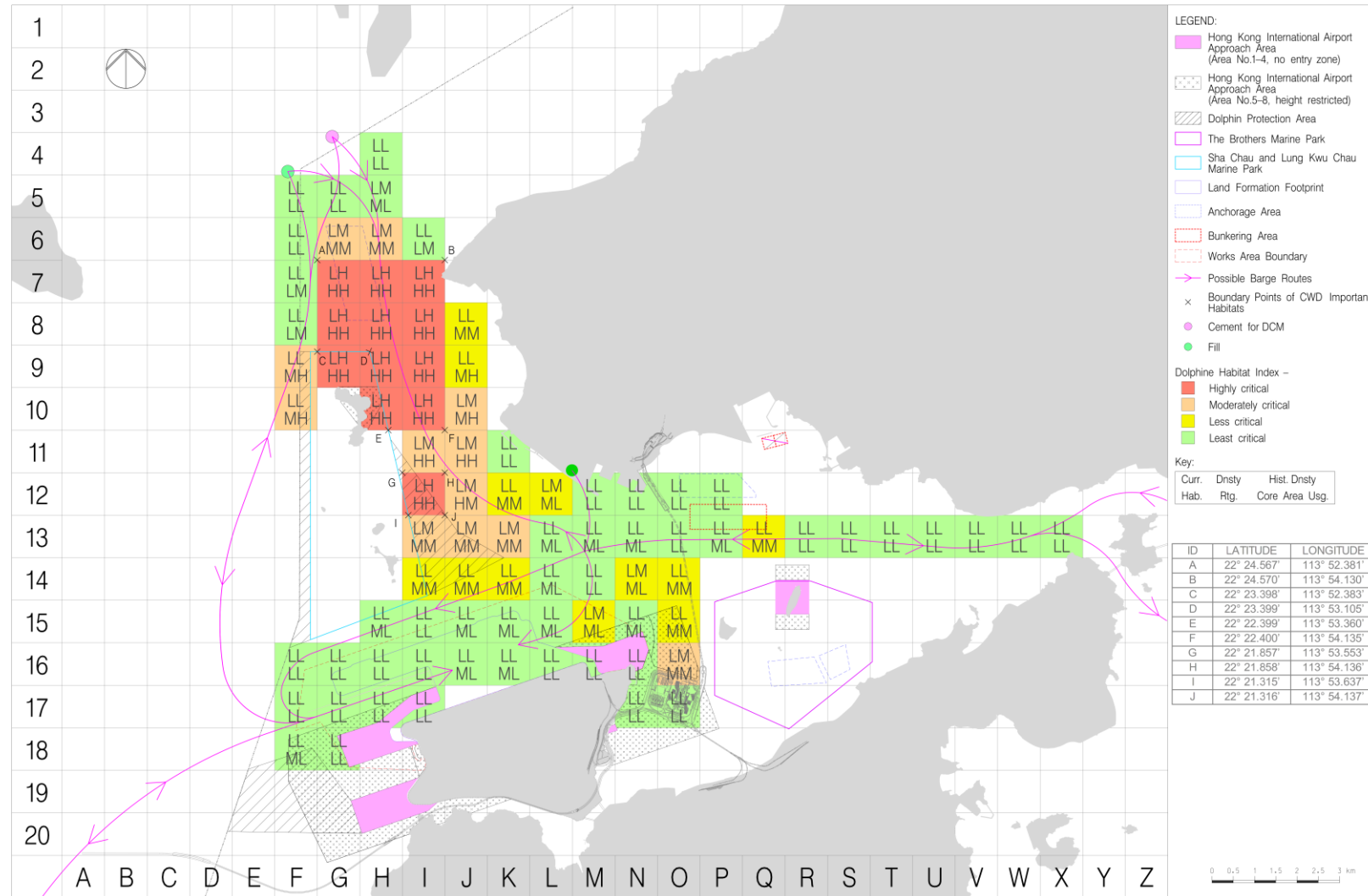


Figure 7-5b: Dolphin Habitat Index and Marine Travel Routes After I-2RS and Before Designation of NLMP

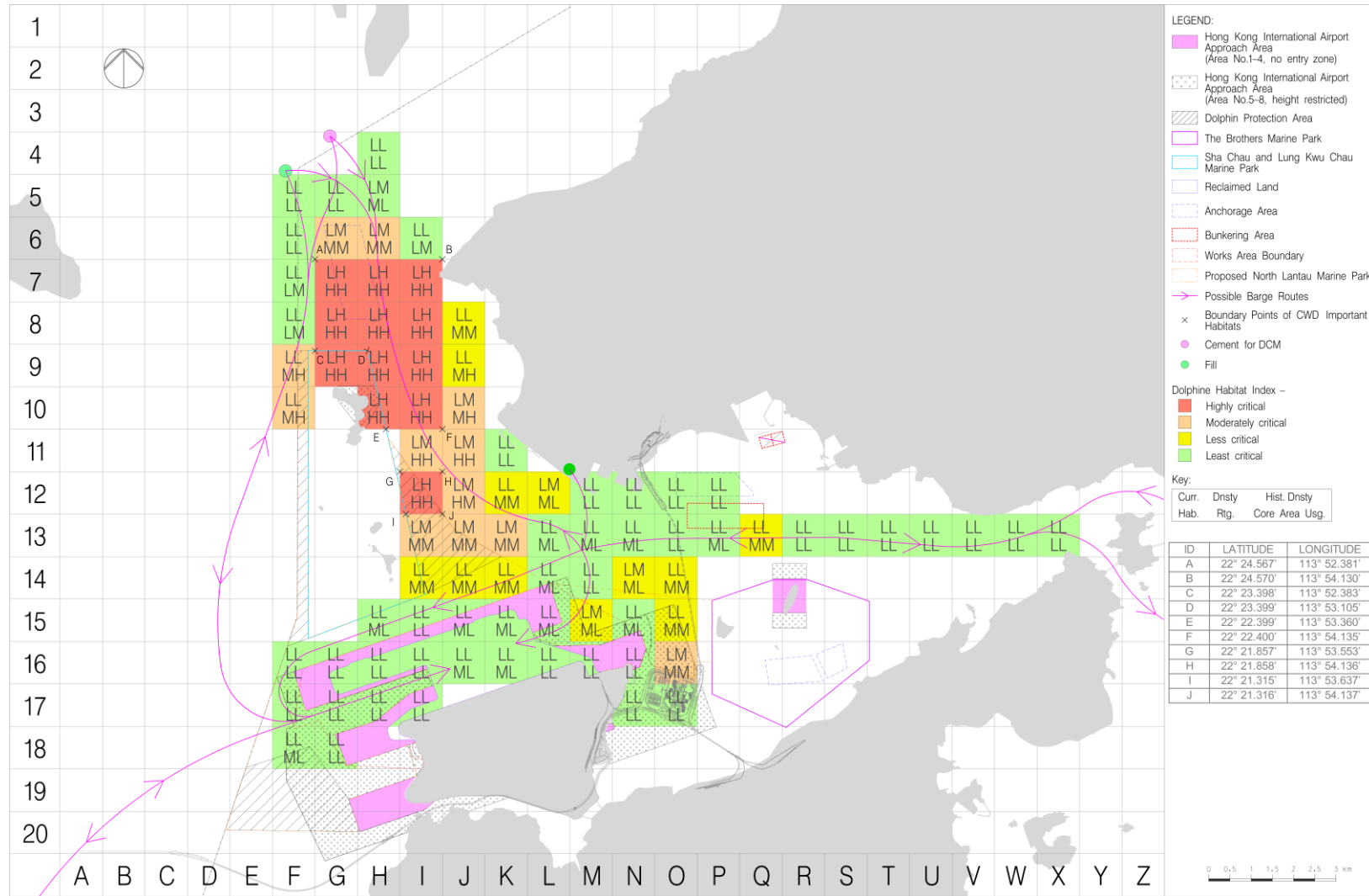
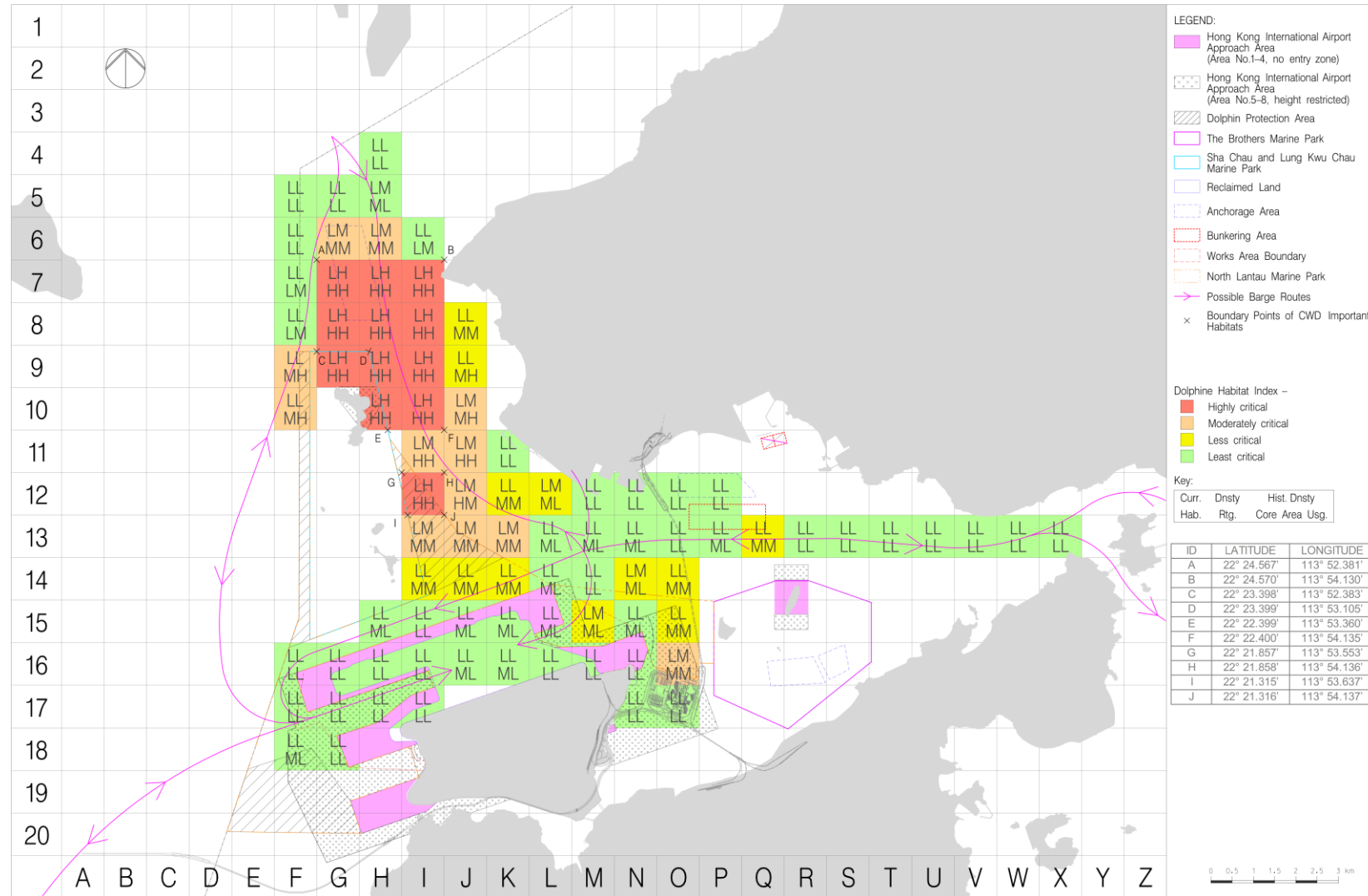


Figure 7-5c: Dolphin Habitat Index and Marine Travel Routes After Designation of NLMP





## 8 Implementation and Monitoring

### 8.1 Method of Implementation and Monitoring

#### 8.1.1 Marine Traffic Monitoring Systems

Construction vessel routes for land formation works have been developed to keep the majority of transits out of Urmston Road and other key channels within Hong Kong Waters. It is recommended that construction vessels access the works site via the west and east site entrances to avoid using the busy channel north of the Works Area.

To monitor and manage 3RS vessel activities, a Marine Traffic Monitoring System (**Figure 8-1**) has been established to ensure that works vessels:

- Travel to/from the Works Area via designated transit routes;
- Access/depart works site via designated site entrances;
- Obey speed limits and any other navigation controls that are prescribed;
- Avoid traversing through existing Marine Parks (including the SCLKCMP, the BMP, SWLMP and SLMP);
- Neither anchor nor stopover within the existing Marine Parks (including the SCLKCMP, the BMP, SWLMP and SLMP) without authorization; and
- After designation of NLMP, the construction and associated vessels have to pass through the NLMP when coming / leaving the Works Area. The construction and associated vessels shall minimize their travelling route within the NLMP, adhere to at a 10-knot speed limit (AFCD, n.d.) when passing through the NLMP and not anchor or stopover within the NLMP.

Key elements of the Marine Traffic Monitoring System will include:

- A requirement for a tracking system (e.g. Automatic Identification System (AIS) Transponders) to be installed on all construction and associated vessels;
- An on-shore control room (with 24-hour operation if night time works is required) to monitor, manage and communicate via Very High Frequency (VHF) or mobile phone and other practical communication system with construction vessels; and
- A clearly defined set of warnings for non-compliance with prescribed navigation controls.

Vessels which deliver materials including for example sandfill, rockfill and prefabricated units are expected to pass through the Urmston Road Fairway and some CWD hotspots. If temporary material delivery vessels that have not been registered with AIS will require a guard boat with AIS installed to lead the way within the Works Area until the vessels station within the Works Area, otherwise, the vessels will not be allowed to enter the Works Area. In order to keep the construction-related vessels to a practical minimum, the site staff transportation vessel could be act as the guard boat during the transitional period. The Contractor shall ensure that the material delivery schedule is arranged where the site staff transportation vessel is able to lead the temporary material delivery vessel to the designated construction Works Area. A tight control on the marine travel routes will be implemented to minimise traveling routes within CWD hotspots.

Site investigation (S.I.) vessels which mainly deployed for preparing the construction works and stationary at specific S.I. monitoring locations at most of the time, are not classified as construction and associated vessels. However, S.I. vessels will also travel to/from the Works Area via designated transit routes and access / depart works site via designated site entrances with speed limit same as other construction vessels. For this kind of S.I. vessel which may not equipped with an AIS tracking system, the Contractor shall provide alternative tracking records

(e.g. global positioning system (GPS) log) to the on-shore control room for auditing. The tracking records shall include the time, date, coordinates, travelling route and travelling speed.

For the newly awarded Contractor onboard, ET will work with the Contractor to review and get familiarised with the requirements of this Updated Plan in the first month including predefined and regular routes for construction vessels covering waters both within and outside the Works Area, speed control within the Works Area, CWDs hotspot areas and Dolphin Protection Areas, as well as providing skipper training to the captains.

### 8.1.2 Record of Travel Route

Tracking systems (e.g. AIS) will be used in all construction and associated vessels to record use of the marine travel routes for track logging.

All daily records of marine travel routes used (including details, times, dates and purpose of journeys) will be maintained by the supervising staff. The records shall be submitted for inspection by Contractor's representatives upon request. The captains of construction vessels and their companies or material suppliers will receive formal warning notice if records show the approved marine travel route was not followed.

During the construction phase the ET will be required to audit the implementation of the requirements detailed in this Updated Plan (e.g. marine travel routes to / from the Works Area, speed etc.). Travel route logs, including coordinate points logging of individual tracks and graphical plots of all vessel tracks overlaid on the base map of Hong Kong, shall be provided to the ET, IEC and AAHK at regular intervals after commencement of the marine construction works.

### 8.1.3 Water Quality and Vessel Movement

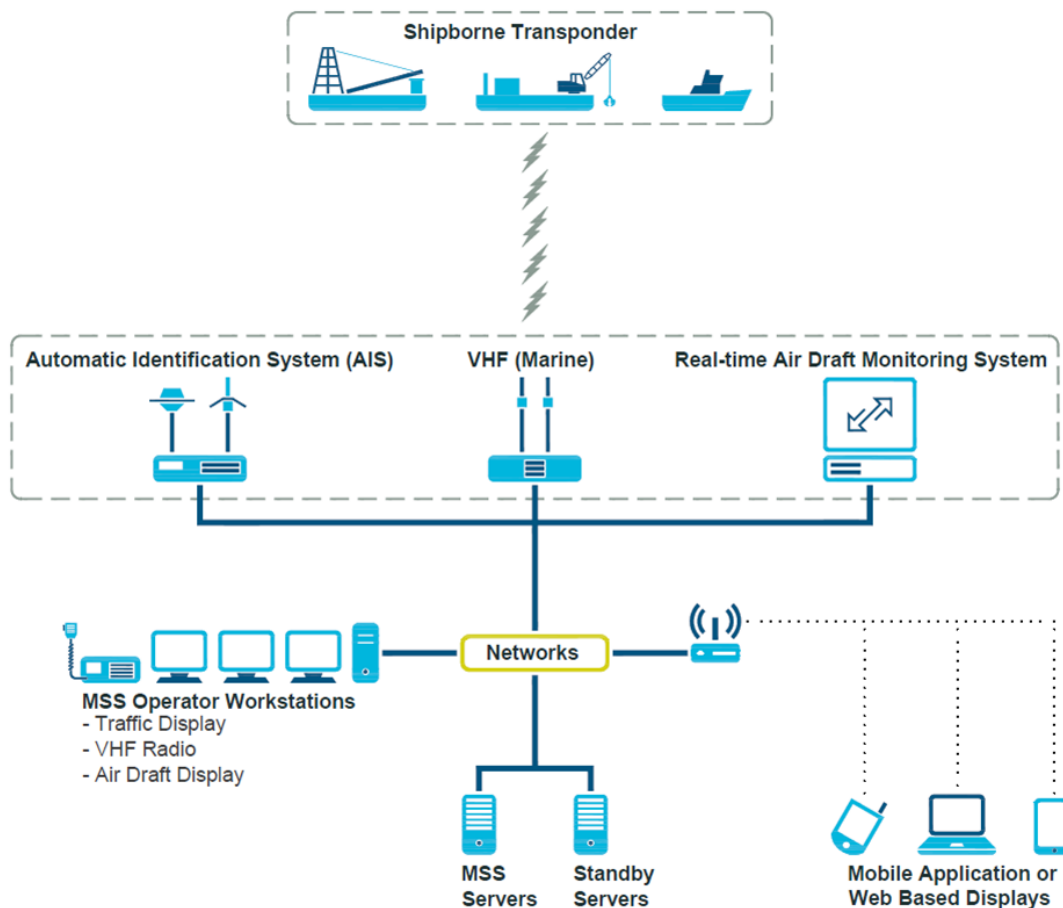
During water quality monitoring, observations of the surrounding activities were recorded. Should exceedance of water quality be recorded, inspection was carried out including checking of the observation log, the AIS data showing the construction traffic route and volume of construction traffic at the time of exceedance. The available records on number of construction vessels within the work site were also reviewed. Actions were taken if exceedance of water quality was recorded according to the Event and Action Plan recommended for the water quality monitoring as presented in the EM&A Manual. In particular, the ET discussed required mitigation measures with the Contractor, IEC, and AAHK/PM. In the event that frequent water quality Action or Limit Level exceedances happened without apparent reasons, efforts were made to analyze if such exceedances are attributable to the number of construction vessels in the works site for consideration of possible remediation actions, such as limiting the number / movement / anchoring or de-anchoring of construction and associated vessels on site.

All construction and associated vessels shall comply with the relevant international conventions, and local regulations and requirements of the Marine Department where applicable, including:

- The Shipping and Port Control Ordinance (Cap. 313);
- The Shipping and Port Control Regulations (Cap. 313A);
- The Merchant Shipping (Miscellaneous Craft) Regulations (Cap. 313F);
- The Merchant Shipping (Safety) Regulations (Cap. 369);
- The Merchant Shipping (Safety) (Signals of Distress and Prevention of Collisions) Regulations (Cap. 369N);
- The Dangerous Goods Ordinance (Cap. 295);
- The Dangerous Goods (Shipping) Regulations (Cap. 295C);
- The Merchant Shipping (Launches and Ferry Vessels) Regulations (Cap. 313E);
- The Merchant Shipping Ordinance and Regulations (Cap. 281);

- The Merchant Shipping (Local Vessels) Ordinances (Cap. 548);
- The Shipping and Port Control (Works) Ordinance (Cap. 313X); and
- The International Regulations for Preventing Collisions at Sea 1972.

**Figure 8-1: Typical Marine Traffic Monitoring System**



## 8.2 Supervision Staff

Implementation would be enforced by AAHK and implemented by the Contractors and will apply to all vessels engaging in construction works under 3RS contract agreements. However, AAHK has ultimate responsibility for overseeing marine traffic control measures as described in **Section 8.1**. Construction related marine vessel traffic management including the implementation of all of the precautionary and mitigation measures as approved by the Statutory Authority will be coordinated by the AAHK established Marine Traffic Monitoring System / on-shore control room using suitable AAHK or specialist consultant staff along with Contractor's representatives if necessary. The ET will monitor and audit the implementation and effectiveness of the precautionary and mitigation measures as stipulated in this Updated Plan.

## 9 Summary and Conclusion

This Updated Plan presents a summary of major construction works and details of the types of vessels and marine plant expected to be involved. Technical guidelines to avoid adverse water quality impacts during vessel operations, as well as practices to keep construction-related vessels and marine plant to a practical minimum have been provided. The different factors considered in determining construction vessel travel routes in the MTIA are summarized and both general and contingency arrangements are provided in the design of the marine travel routes.

Specifications for skipper training as well as guidelines for safe vessel operations in the presence of CWD are covered in this Updated Plan. A 10-knot speed restriction is designated within the Works Area, the NLMP (after designation) and in 'highly critical' dolphin habitats that have been determined by Dolphin Habitat Index making reference to the AFCD monitoring reports of marine mammals in Hong Kong waters. In addition, methods of implementing and monitoring the effectiveness of the proposed mitigation and precautionary measures through the use of an AAHK established and managed Marine Traffic Monitoring System / on-shore control room are detailed. This facility will be managed by AAHK and overseen by the ET to ensure compliance to this Updated Plan by all 3RS vessel operators. The predefined and regular routes for construction vessels are subject to further review during construction stages and this Updated Plan shall be updated as necessary.

## 10 References

Agriculture, Fisheries and Conservation Department. (n.d.) *Marine Parks Management*. Agriculture, Fisheries and Conservation Department for the Hong Kong SAR Government. Available from [https://www.afcd.gov.hk/english/country/cou\\_vis/cou\\_vis\\_mar/cou\\_vis\\_mar\\_pla/cou\\_vis\\_mar\\_pla\\_mppm.html](https://www.afcd.gov.hk/english/country/cou_vis/cou_vis_mar/cou_vis_mar_pla/cou_vis_mar_pla_mppm.html)

BMT. (2014). *Marine Traffic Impact Assessment for Hong Kong International Airport Contract P281 – Third Runway Reclamation Design Consultancy Services – Scheme Design Report*.

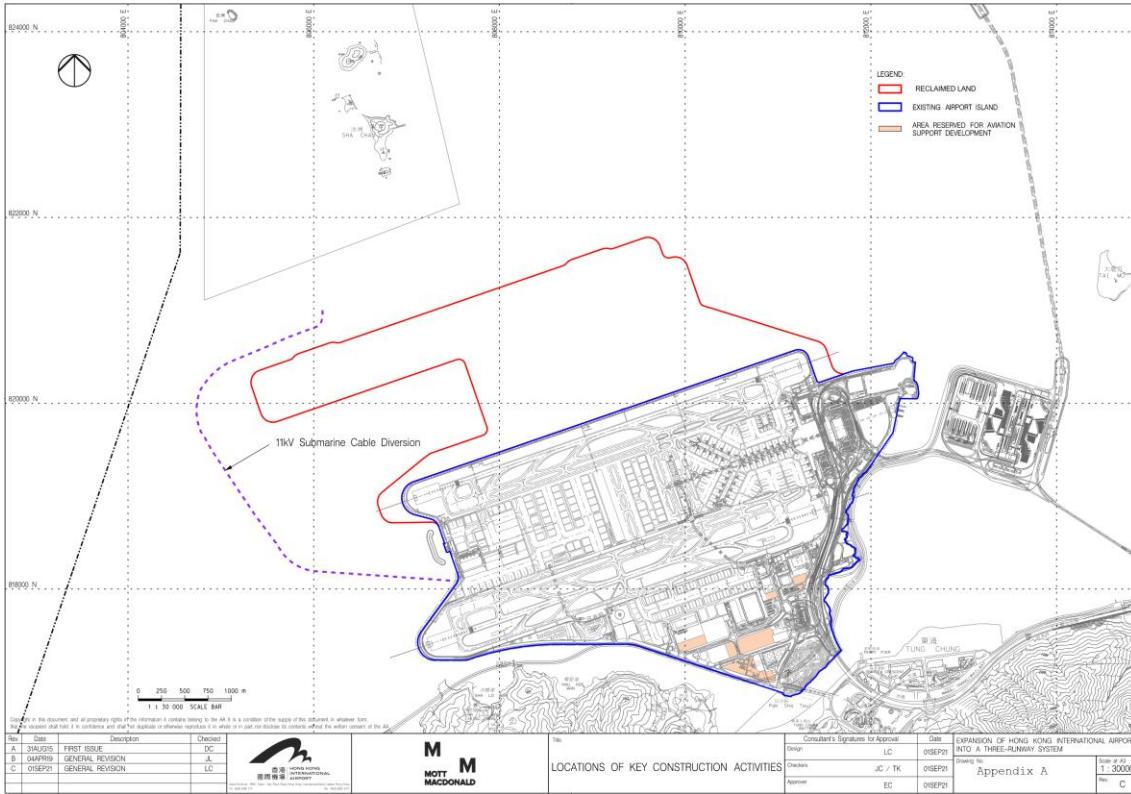
Hung, S. K. 2008. *Habitat use of Indo-Pacific humpback dolphins (Sousa chinensis) in Hong Kong. Ph.D. dissertation*. University of Hong Kong, Hong Kong, 266 p.

Hung, S. K. Y. (2014). *Monitoring of marine mammals in Hong Kong waters (2013-14)*: Final report (1 April 2013 to 31 March 2014). Submitted to the Agriculture, Fisheries and Conservation Department of the Hong Kong SAR Government. Retrieved from <http://www.afcd.gov.hk>

Hung, S.K.Y. (2015) *Monitoring of marine mammals in Hong Kong waters (2014-15)*: Final report (1 April 2014 to 31 March 2015). Submitted to the Agriculture, Fisheries and Conservation Department for the Hong Kong SAR Government. Available from <http://www.afcd.gov.hk>.

Hung, S.K.Y. (2023) *Monitoring of marine mammals in Hong Kong waters (2022-23)*: Final report (1 April 2022 to 31 March 2023). Submitted to the Agriculture, Fisheries and Conservation Department for the Hong Kong SAR Government. Available from <http://www.afcd.gov.hk>.

# Appendix A Project Location



Copyright in this document and all proprietary rights in the information contained herein, in this file, is a condition of the supply of the software in whatever form. It is requested that full 2-D confidence and that not be applied in otherwise reproduced in whole or in part, nor disclosed to others, without the written consent of the copyright owner.

No.	Date	Description	Checked
A.	03/09/21	FIRST ISSUE	DC
B.	04/04/22	GENERAL REVISION	JL
C.	03/05/23	GENERAL REVISION	LC



LOCATIONS OF KEY CONSTRUCTION ACTIVITIES

Consultant's Signatures to Approve:

Design: LC / 03/05/21

Checked: JC / TK / 03/05/21

Approved: EC / 03/05/21

EXPANSION OF HONG KONG INTERNATIONAL AIRPORT INTO A THREE-RUNWAY SYSTEM

Drawing No. Appendix A

Scale of A3: 1:50,000

Rev. C

## Appendix B Working Vessels Involved in the Construction Activities


Vessel Type	*Depth / Draft (m)
Crane Barge/Derrick Barge	Depth: approx. 5.51 Draft: approx. 4.1
Trailing Suction Hopper Dredger (TSHD)	N.A.
Spreader Pontoon	N.A.



Vessel Type	*Depth / Draft (m)
DCM Barge	Depth: approx. 3.50 Draft: approx. 1.50
	Depth: approx. 4.5 Draft: approx. 2.5  Depth: approx. 5.0 Draft: approx. 3.0
PVD Barge	Depth: approx. 4.30 Draft: approx. 3.0  Depth: approx. 3.20 Draft: approx. 2.0
	
Cement Barge	N.A.
	
Hopper Barge for delivery of Public Fill	Depth: approx. 5.50 Draft: approx. 4.1
	



Vessel Type	*Depth / Draft (m)
Water Jetting Barge	N.A.
	
Flat-top Barge	N.A.
	
Pelican Barge	N.A.
	
Tug Boat	N.A.
	

Vessel Type	*Depth / Draft (m)
Anchor Boat	N.A.
 A white anchor boat with a yellow crane on deck, floating on the water.	
Transportation Boat / Ferry	N.A.
 A blue and white transportation boat or ferry with lifebuoys on the deck.	
Jack-up Platform	N.A.
 A red and yellow jack-up platform with a banner that reads "SAFETY FIRST" and a green cross symbol.	

**Vessel Type**

**\*Depth / Draft (m)**

Roro Barge



N.A.

## Appendix C Code of Conduct in the Presence of Dolphins

1. Maintain forward progress at a slow, steady speed or stop with no sudden course changes. Vessel speed shall not exceed 10 knots ;
2. Always slow down to no-wake speed, or stop if animals appear directly ahead within 100 meters;
3. Never approach the dolphins head on;
4. Never conduct reverse throttling in the vicinity of dolphins;
5. Never chase or cut across the course of dolphins, separate mothers and calves, split up groups or 'corner' dolphins between boats, nets or shore;
6. Never attempt to touch, swim with, feed or harm the dolphins;
7. Do not litter or dispose of any fuel, oil or other pollutants in the waters;
8. Respect the dolphins and let them make the choice to continue their course or flee, do not attempt to force the dolphins to change course and avoid your vessel; and
9. When it is observed that the dolphins are following pair trawlers in the area:
  - a. Change the vessel position relative to the marker buoy of the trawl net as slowly as possible;
  - b. Do not pass by at high speed after trawlers have hauled up the net;
  - c. Move away from the area at low speed very cautiously and only after the dolphins have dispersed

## Appendix D Implementation Schedule for Marine Travel Routes and Management Plan for Construction and Associated Vessels

MTRMP-CAV ref.	Recommended Mitigation Measures	Objectives of the Recommended Measures & Main Concerns to address	Who to Implement / Mainain the Measures	Location of the Measures	When to Implement the Measures?	
Section 4.1 & 4.4	<ul style="list-style-type: none"> <li>Submit 3-month rolling programme of planned vessel movements and passenger statistic of passenger vessels</li> </ul>	To keep construction-related vessels to a practical minimum	All Contractors*	All areas north and west of Lantau Island during construction phase	Construction Phase	
Section 6.1, 6.2 and 6.3	<ul style="list-style-type: none"> <li>All skippers of relevant construction and associated vessels shall be trained by ET on predefined routes, general education on local cetaceans, guidelines for avoiding adverse water quality impact, the required environmental practices / measures while operating construction and associated vessels under the Project, and guidelines for operating vessels safely in the presence of CWDs.</li> </ul>	To minimise the chance of vessel collision with CWD, potential water quality impacts, and the disturbance to the CWD during construction of the project.	ET and All Contractors*	All areas north and west of Lantau Island during construction phase	Construction Phase	
Section 8.1.1	<ul style="list-style-type: none"> <li>Establish a Marine Traffic Monitoring System to monitor and ensure that the 3RS vessels activities:               <ol style="list-style-type: none"> <li>Travel to/from the Works Area via designated transit routes;</li> <li>Access/depart works site via designated site entrances;</li> <li>Obey speed limits and any other navigation controls that are prescribed;</li> <li>Construction and associated vessels shall avoid traversing through existing Marine Parks (including the SCLKCMP, the BMP, SWLMP and SLMP);</li> <li>Neither anchor nor stopover within the existing Marine Parks area without authorization; and</li> </ol> </li> </ul>	To minimise the chance of vessel collision with CWD, potential water quality impacts, and the disturbance to the CWD during construction of the project.	AAHK & Contractors*	All	All areas north and west of Lantau Island during construction phase	Construction Phase

MTRMP-CAV ref.	Recommended Mitigation Measures	Objectives of the Recommended Measures & Main Concerns to address	Who to Implement / Maintain the Measures	Location of the Measures	When to Implement the Measures?
	6. After designation of NLMP, the construction and associated vessels shall minimize their travelling route within the NLMP, adhere to at a 10-knot speed limit when passing through the NLMP and not anchor or stopover within the NLMP.				



**mottmac.hk**