

Schematic Drawing of Typical Noise Enclosure for Static Plant (e.g. Generators etc.) (~3–4m tall)

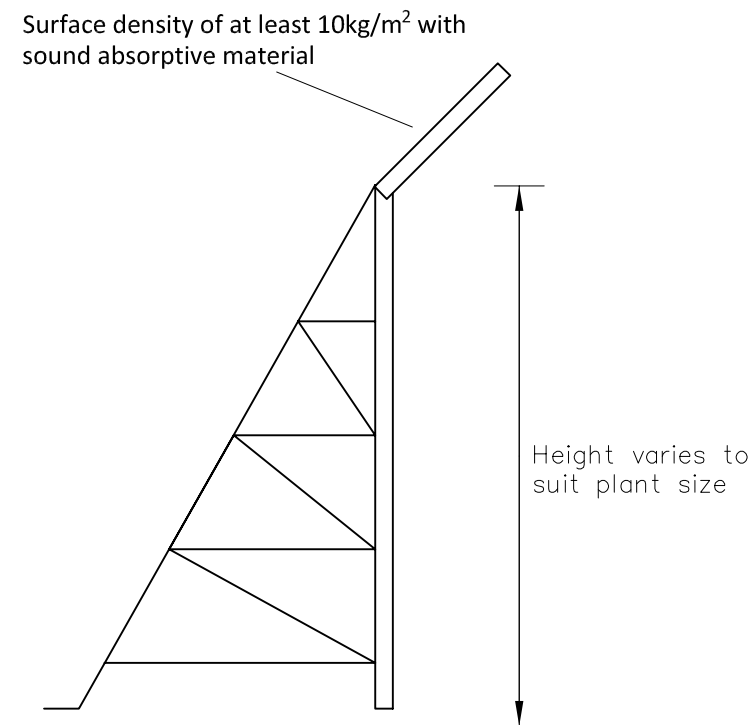

Schematic Drawing of Temporary Noise Barrier for Mobile Plant / Static Plant (~4–6m tall)

LEGEND

Rev	Date	Descriptions	Check
-----	------	--------------	-------



HONG KONG INTERNATIONAL AIRPORT



Consultant's Signatures for Approval

Design Supervisor

Checkers

Authorised Representative

Key Plan

Title

AIRPORT TUNG CHUNG LINK PROJECT
Schematic Drawing of Mitigation Measures

Drawing No.

Appendix 4.5

Originator	Location	Discipline	Type	Desig. Sequence No.
Status	Design	Scale	As shown	Rev Design

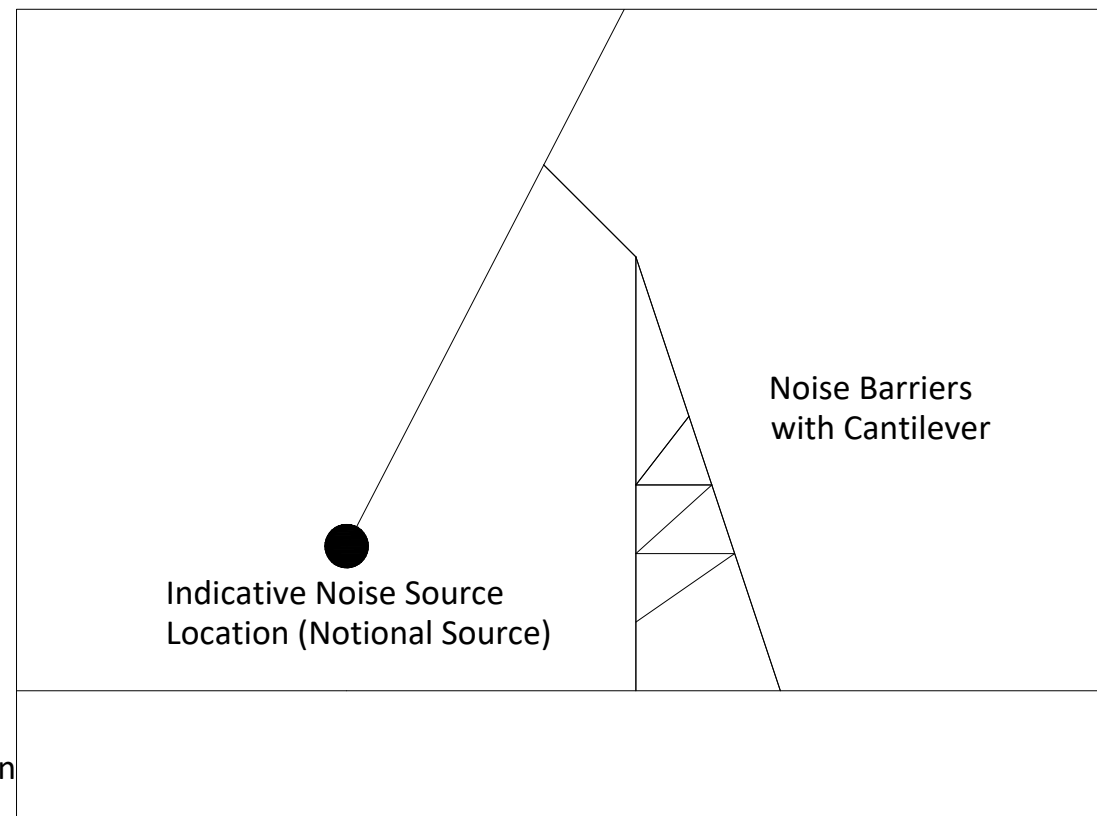
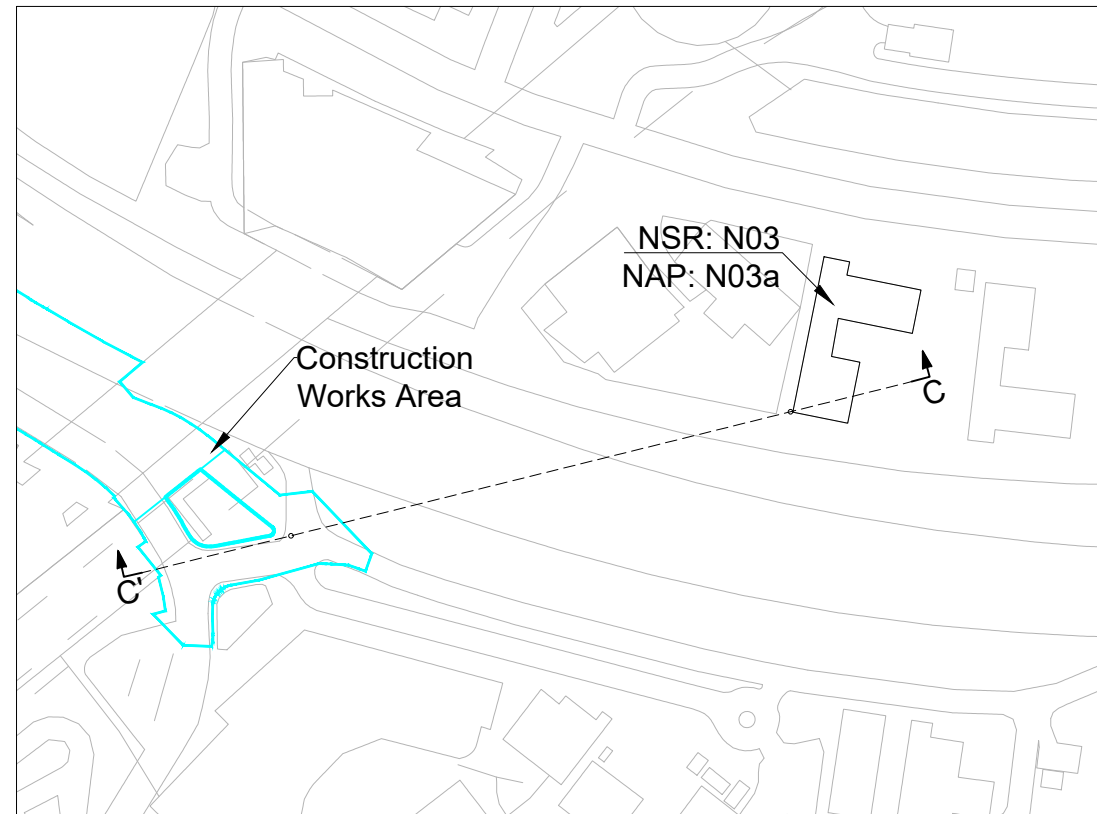

NSR: N03 - Ling Liang Church E Wun Secondary School

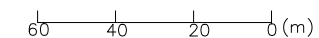

LEGEND

Rev	Date	Descriptions	Check



HONG KONG INTERNATIONAL AIRPORT

Consultant



Consultant's Signatures for Approval

Design Supervisor	Date
Checkers	
Authorized Representative	

Key Plan



Title
AIRPORT TUNG CHUNG LINK PROJECT
Schematic Drawing of Mitigation Measures

Drawing No.

Appendix 4.5

Originator	Location	Discipline	Type	Dwg Sequence No.
Design		Scale	As shown	Rev Design

93.1 mPD

NSR: N08 -
Fu Tung Estate
Tung Ma House

7.3 mPD

D'

D

6.7 mPD

60 40 20 0 (m)

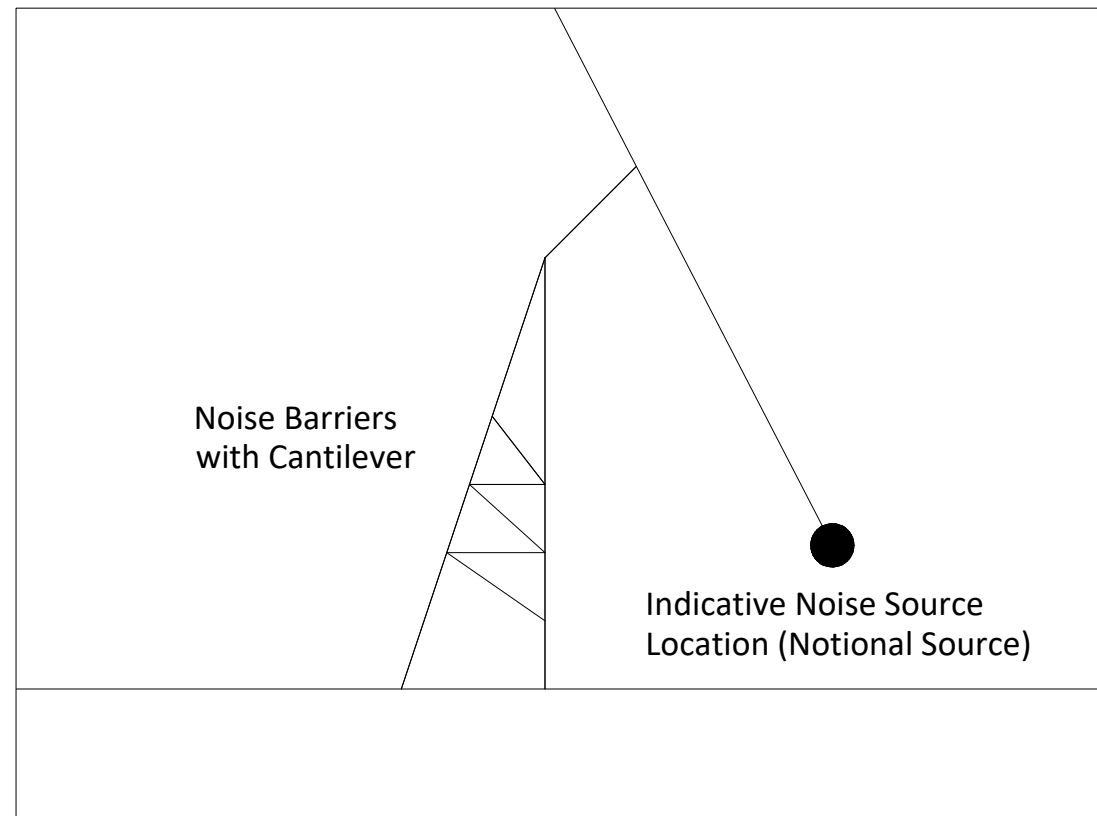
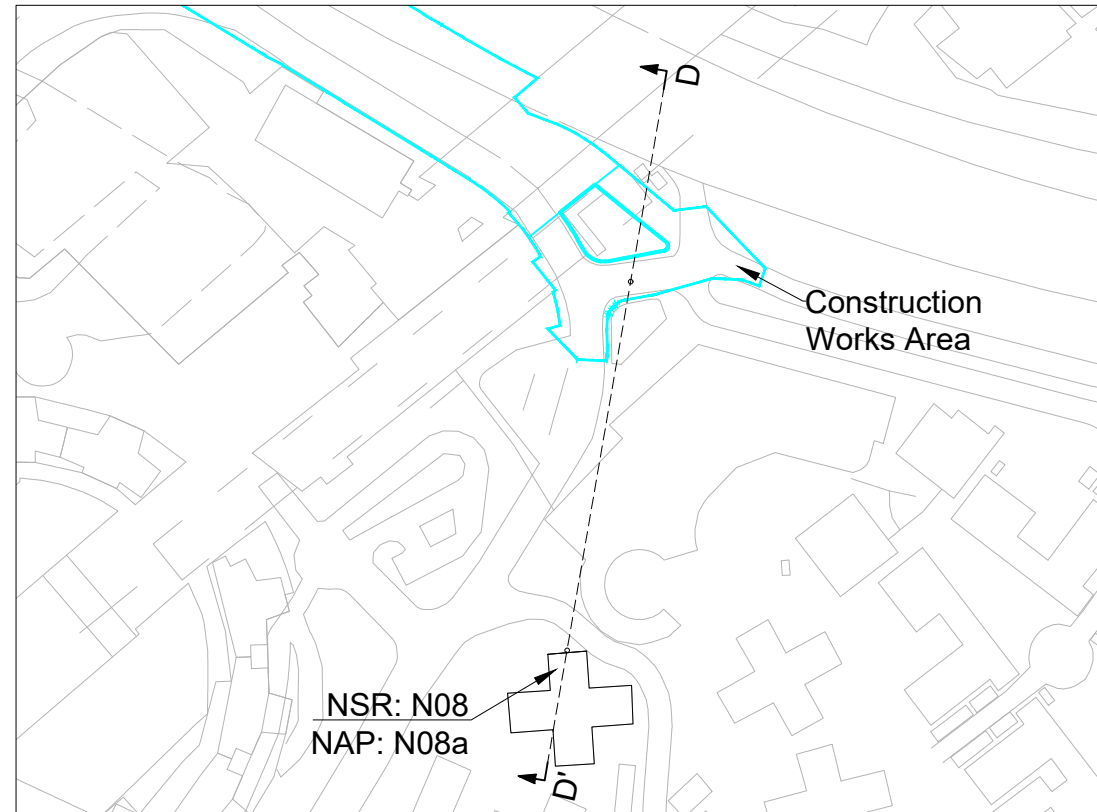

LEGEND

Rev	Date	Descriptions	Check



HONG KONG INTERNATIONAL AIRPORT

Consultant



Consultant's Signatures for Approval

Design Supervisor	Date
Checkers	
Authorized Representative	

Key Plan



Title

AIRPORT TUNG CHUNG LINK PROJECT
Schematic Drawing of Mitigation Measures

Drawing No.

Appendix 4.5

Originator	Location	Discipline	Type	Dwg Sequence No.
Status	Design	Scale	As shown	Rev Design

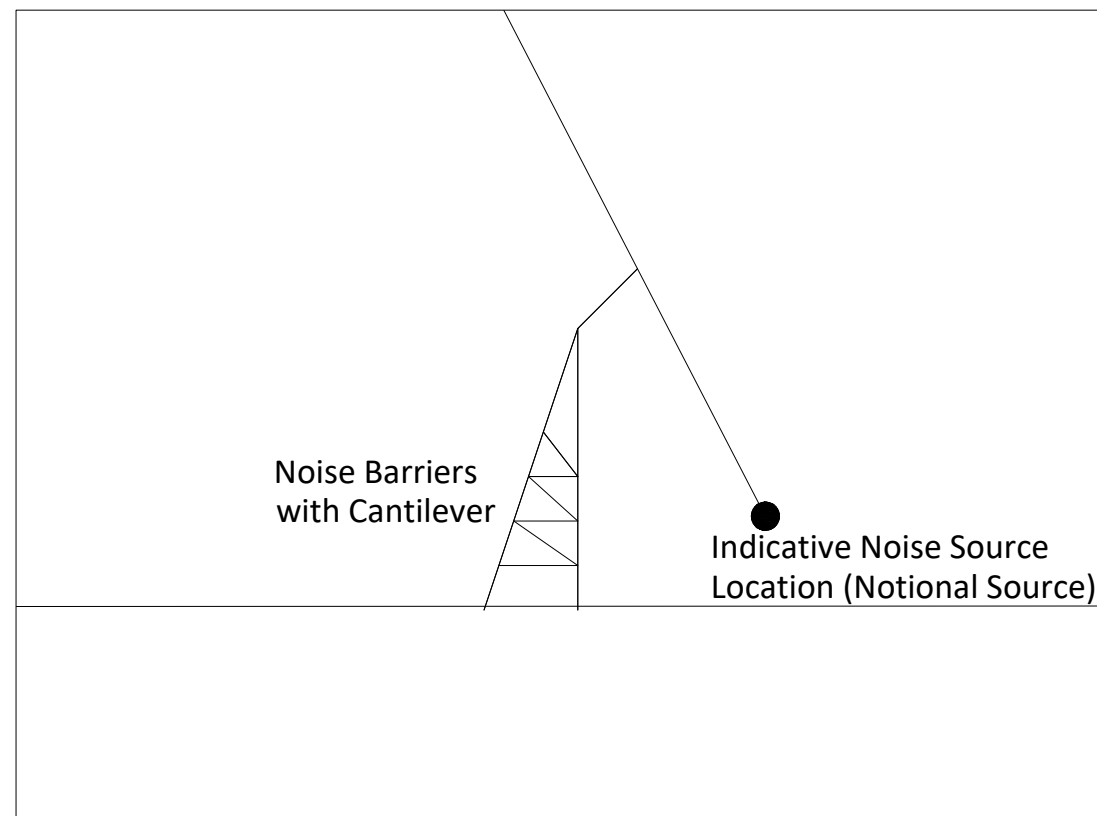
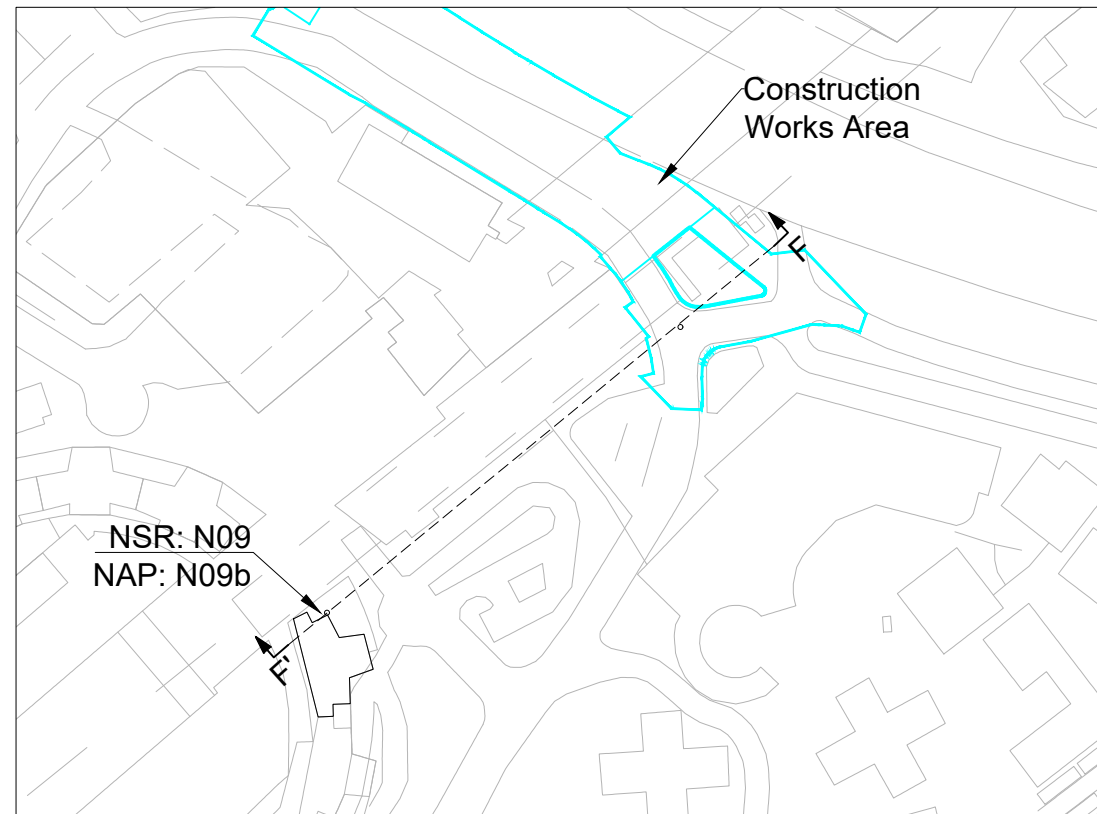
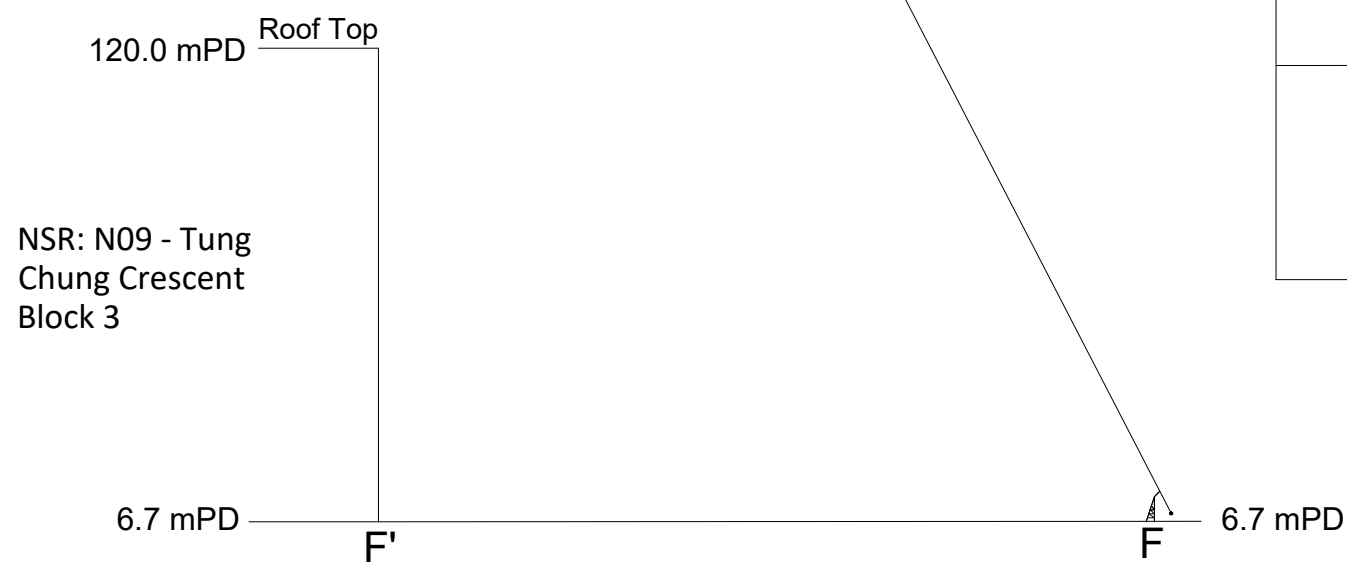

LEGEND

Rev	Date	Descriptions	Check



HONG KONG INTERNATIONAL AIRPORT



Consultant's Signatures for Approval		Date
Design Supervisor		
Checkers		
Authorized Representative		

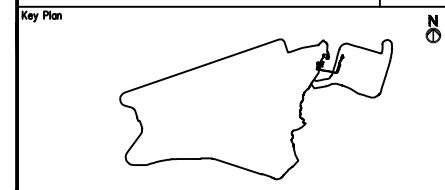

Title
AIRPORT TUNG CHUNG LINK PROJECT
Schematic Drawing of Mitigation Measures

Drawing No.
Appendix 4.5

Originator	Location	Discipline	Type	Draw Sequence No.
Design		Scale	As shown	Rev Design

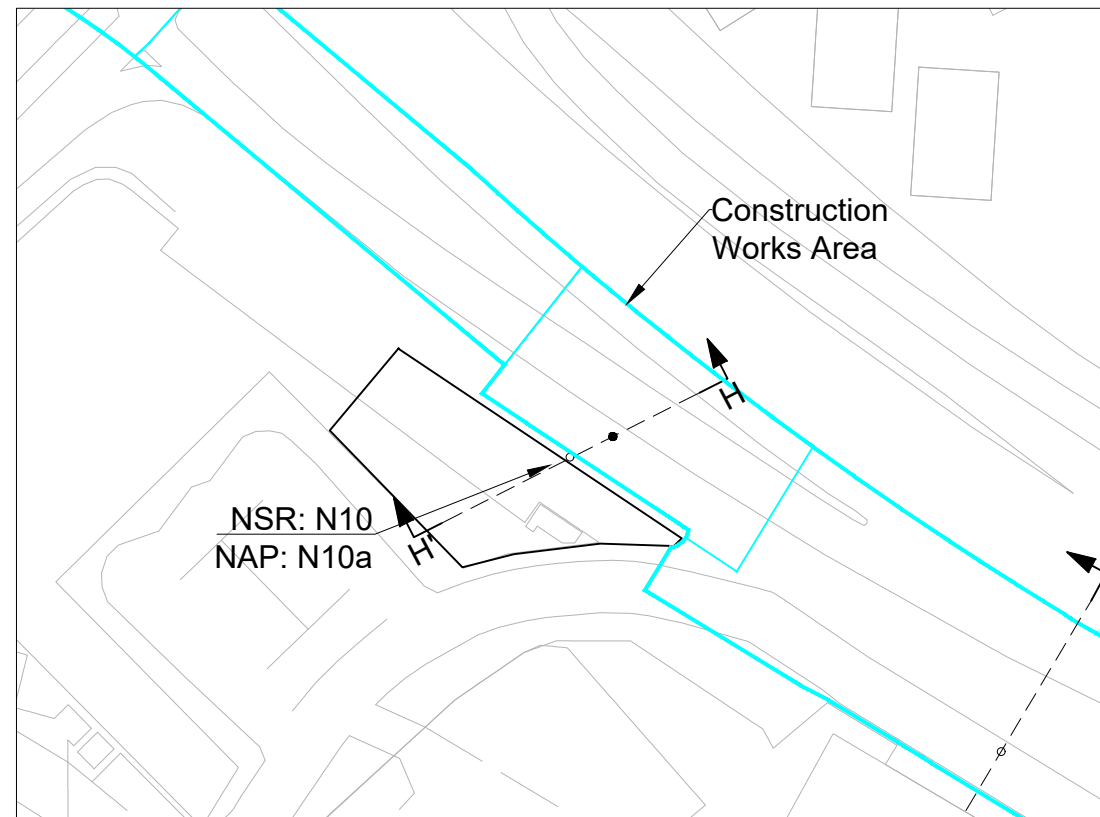
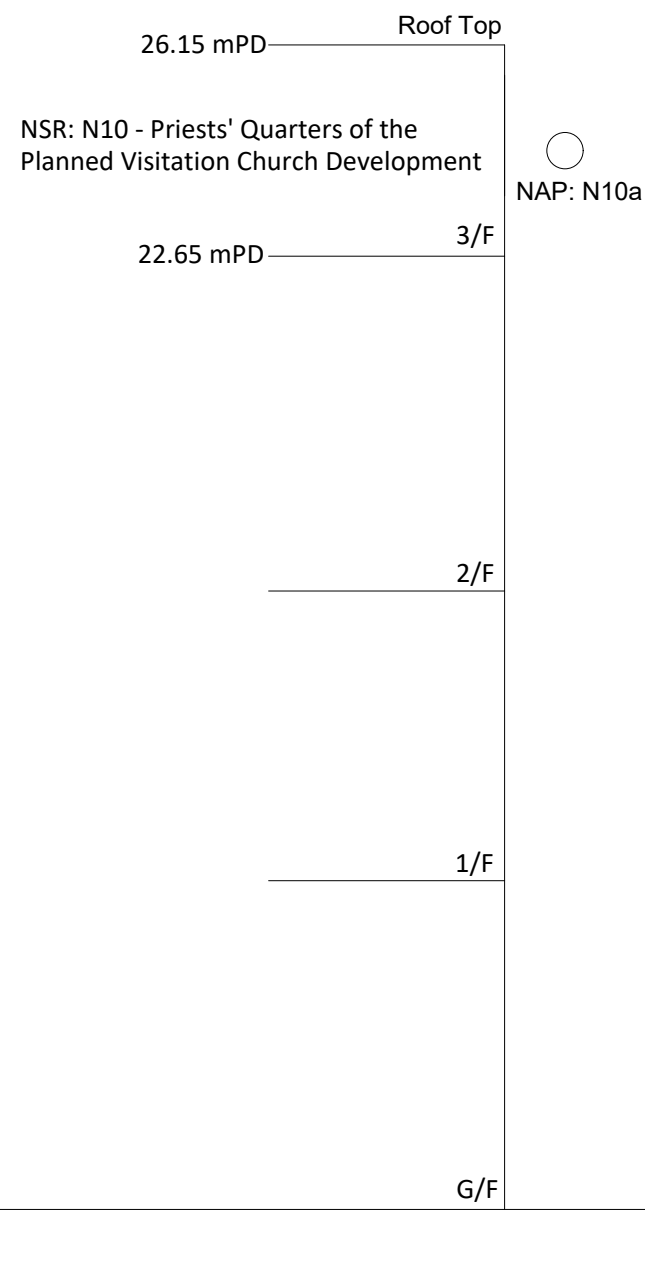

LEGEND

Rev	Date	Descriptions	Check



HONG KONG INTERNATIONAL AIRPORT



Consultant's Signatures for Approval

Design Supervisor

Checkers

Authorized Representative

Key Plan



Title

AIRPORT TUNG CHUNG LINK PROJECT

Schematic Drawing of Mitigation Measures

Drawing No.

Appendix 4.5

Originator	Location	Discipline	Type	Dwg Sequence No.
Design		Scale	As shown	Rev Design

