

Tracer Concentration During Neap Ebb Tide in Dry season at 0hr & 1 hr
 Top: Baseline; Bottom: Project; Left: 0hr; Right: 1hr

0622478

ERM

WQ/Tracer

Tracer₂.fig

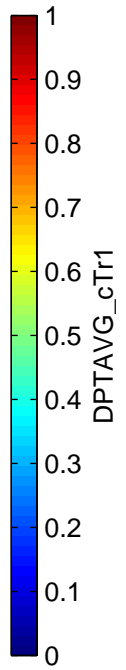
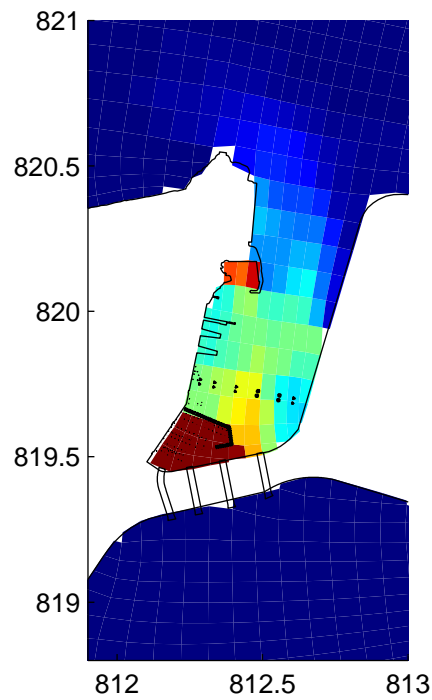
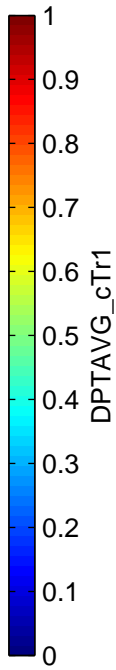
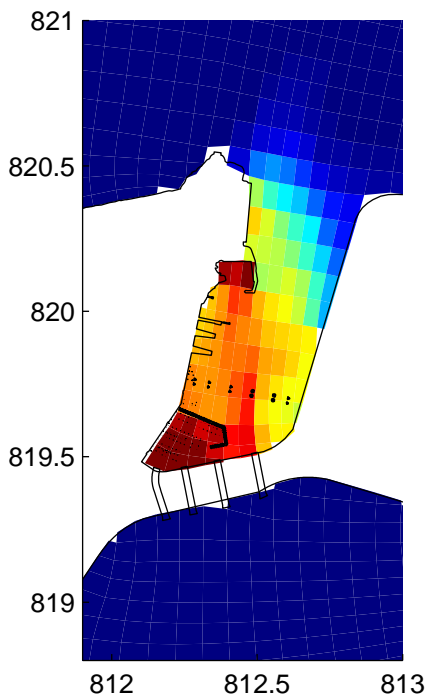
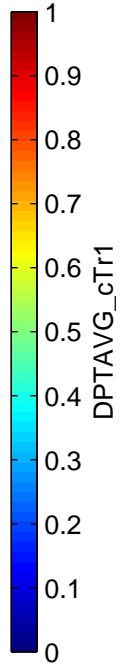
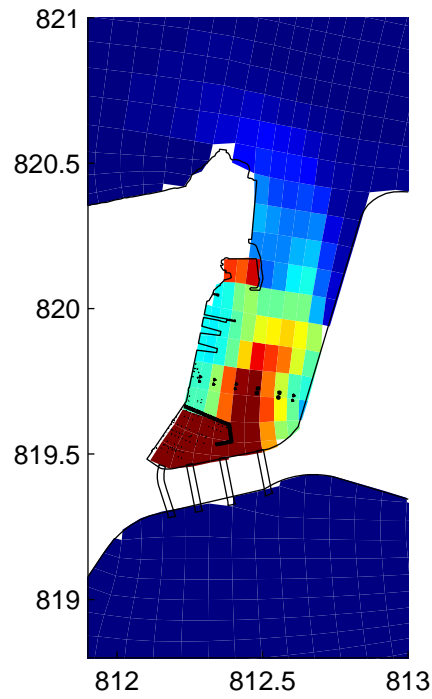
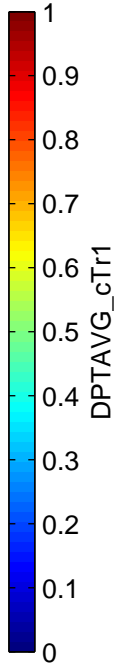
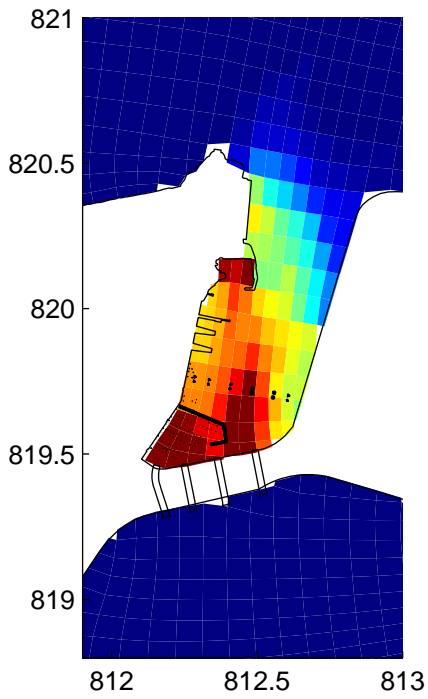

Tracer Concentration During Neap Ebb Tide in Dry season at 2hr & 4 hr
 Top: Baseline; Bottom: Project; Left: 2hr; Right: 4hr

0622478

ERM

WQ/Tracer

Tracer₂.fig

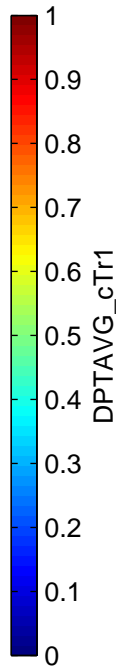
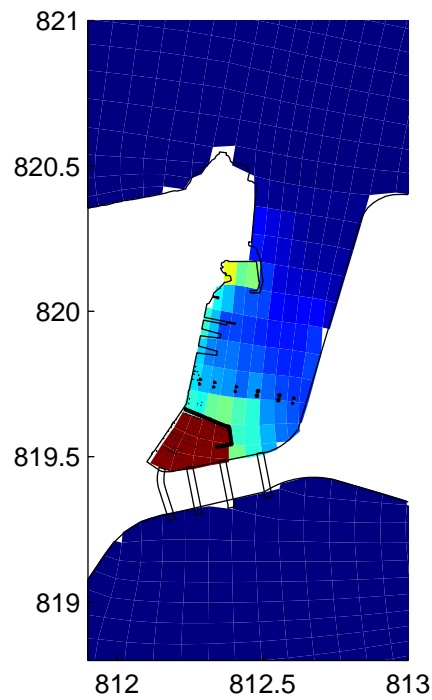
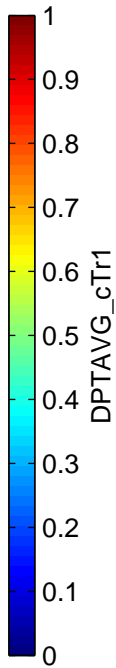
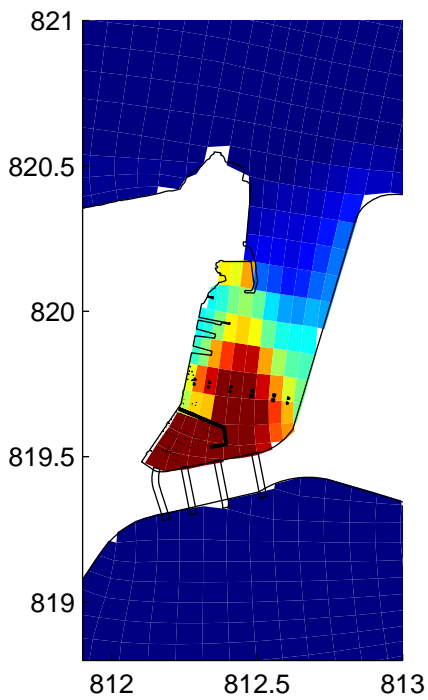
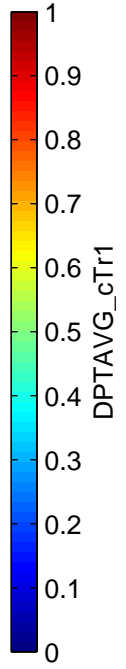
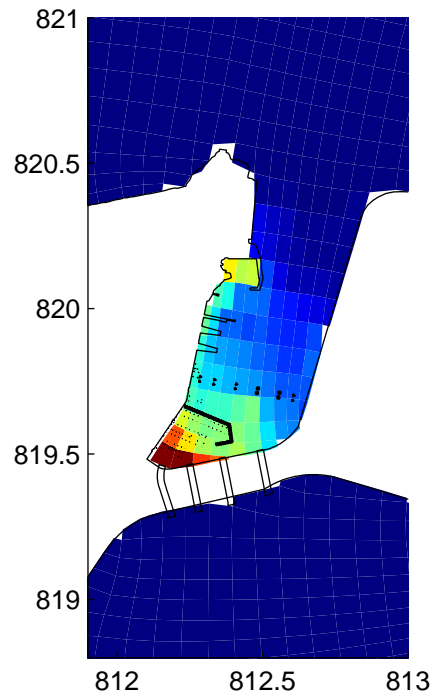
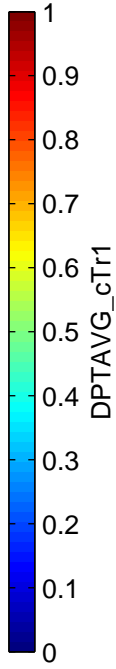
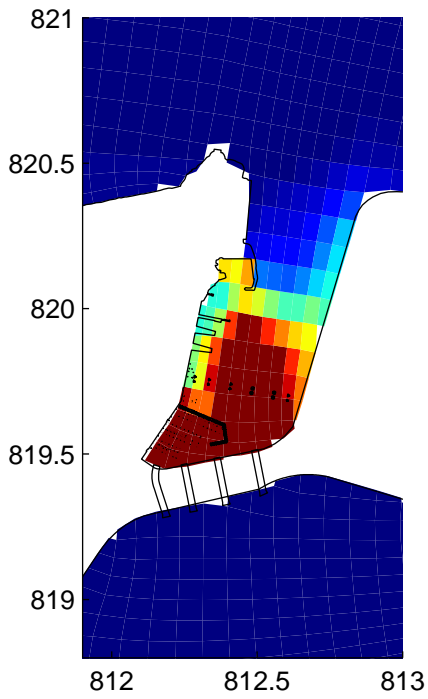

Tracer Concentration During Neap Ebb Tide in Dry season at 8hr & 12 hr
 Top: Baseline; Bottom: Project; Left: 8hr; Right: 12hr

0622478

ERM

WQ/Tracer

Tracer₂.fig

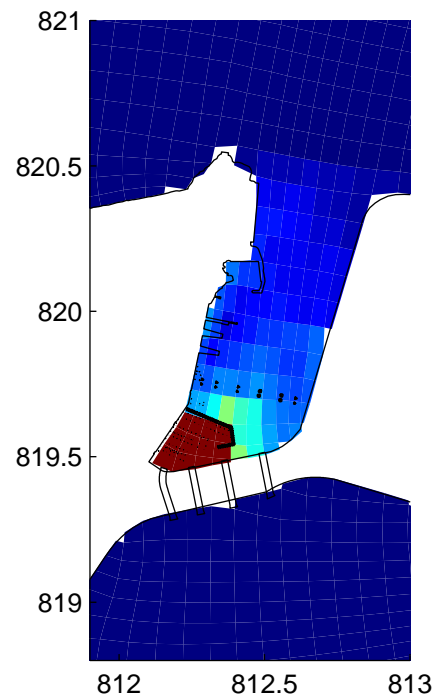
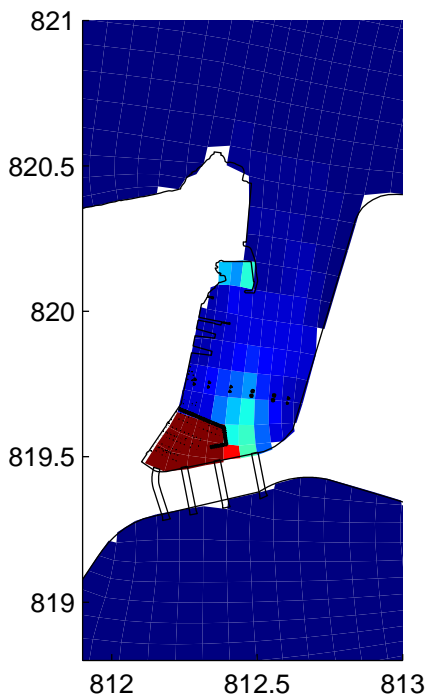
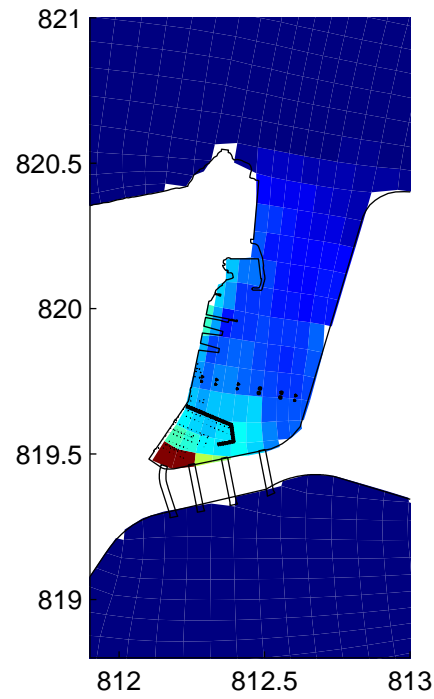
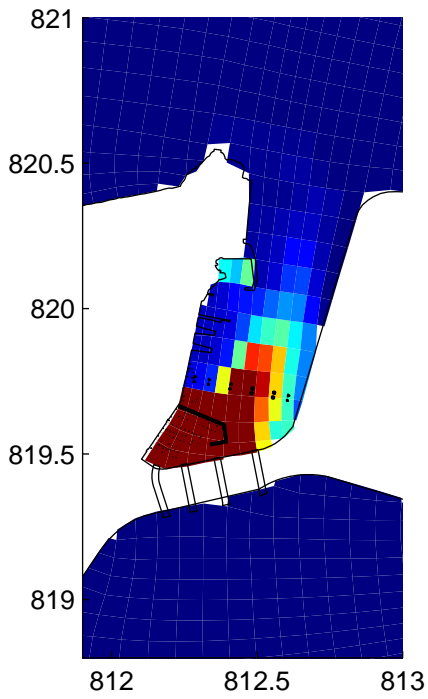

Tracer Concentration During Neap Ebb Tide in Dry season at 16hr & 24 hr
 Top: Baseline; Bottom: Project; Left: 16hr; Right: 24hr

0622478

ERM

WQ/Tracer

Tracer₂.fig

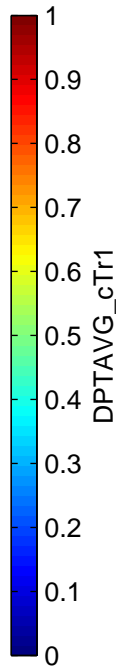
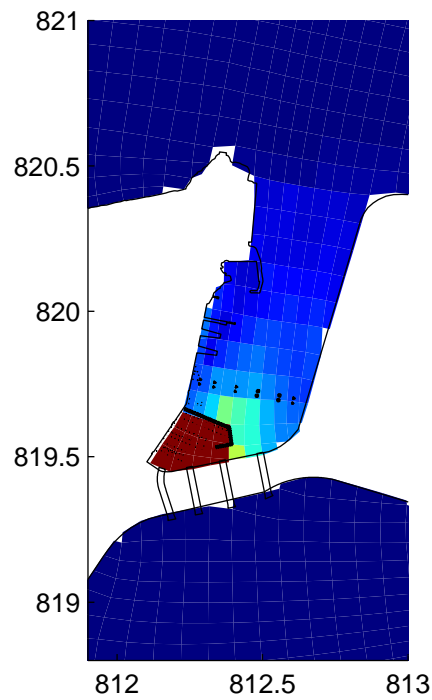
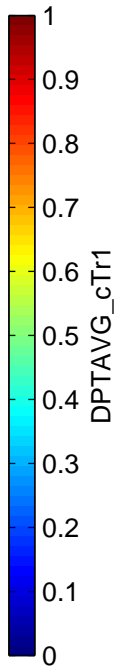
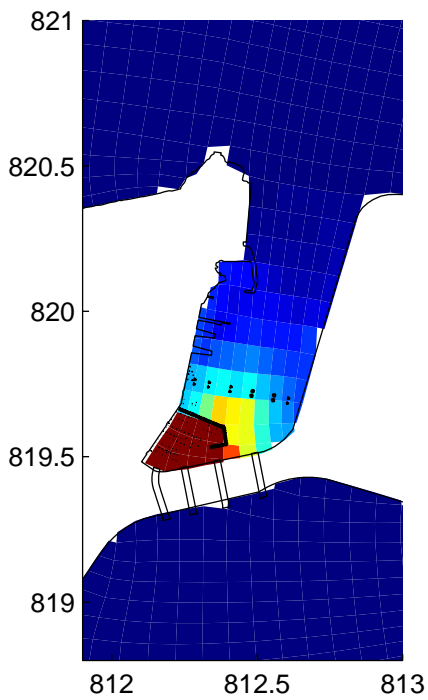
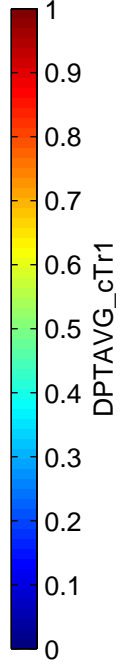
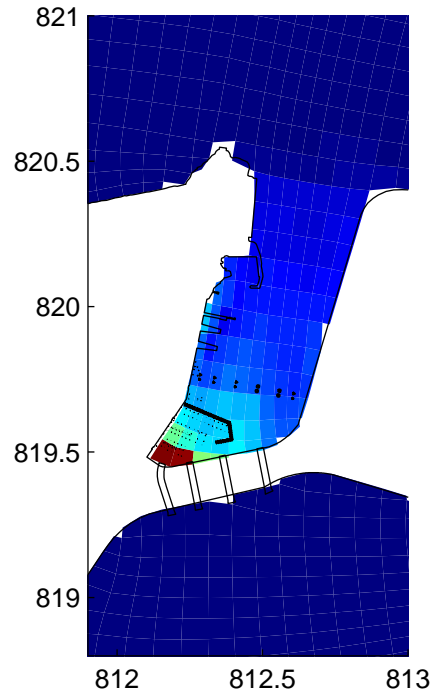
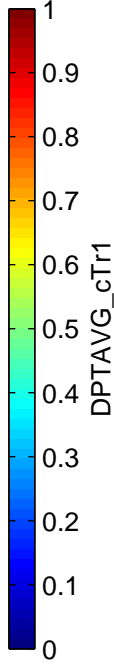
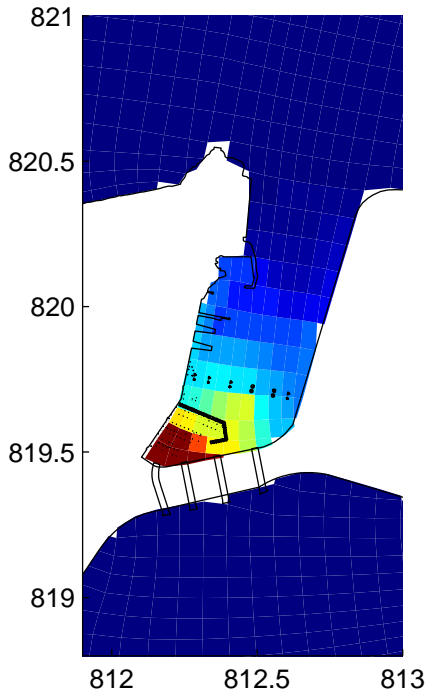

Tracer Concentration During Neap Ebb Tide in Dry season at 36hr & 48 hr
 Top: Baseline; Bottom: Project; Left: 36hr; Right: 48hr

0622478

ERM

WQ/Tracer

Tracer₂.fig

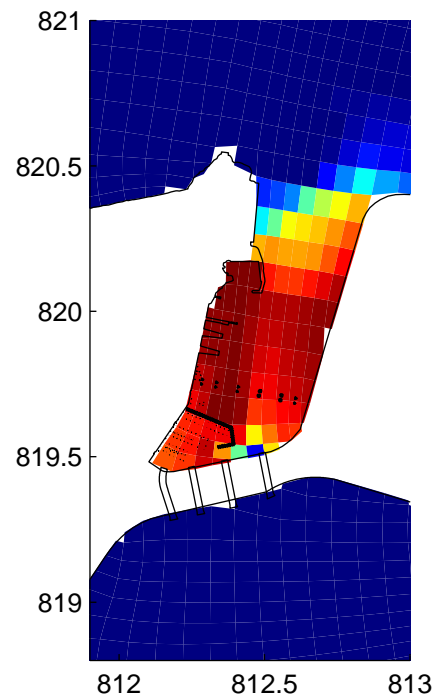
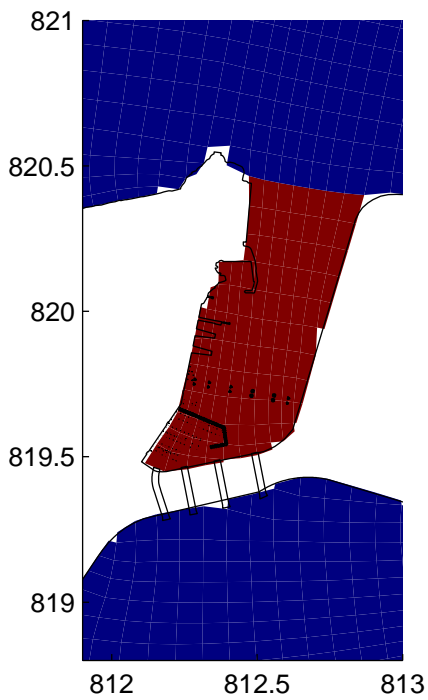
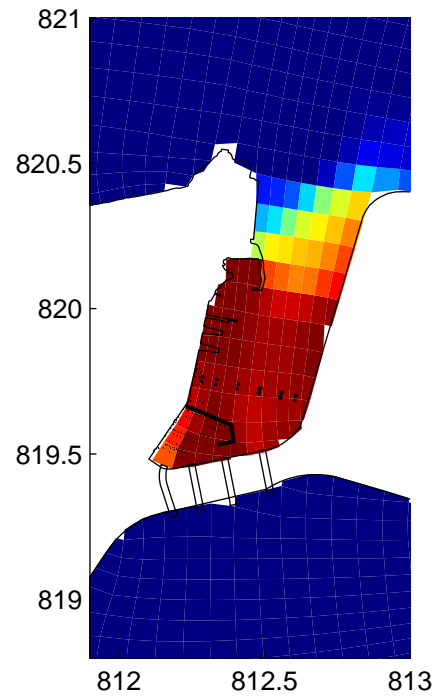
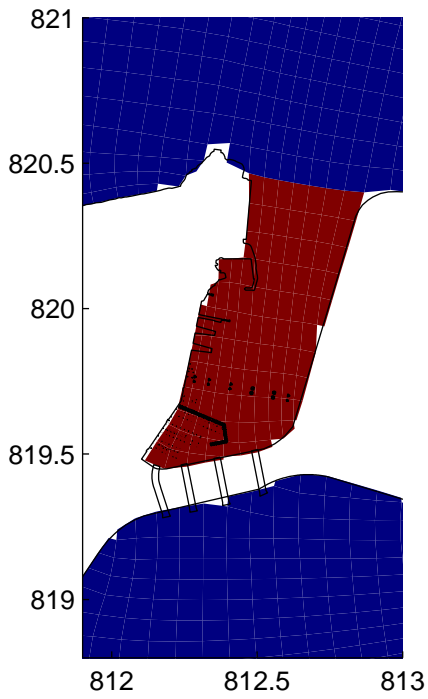

Tracer Concentration During Neap Flood Tide in Dry season at 0hr & 1 hr
 Top: Baseline; Bottom: Project; Left: 0hr; Right: 1hr

0622478

ERM

WQ/Tracer

Tracer₂.fig

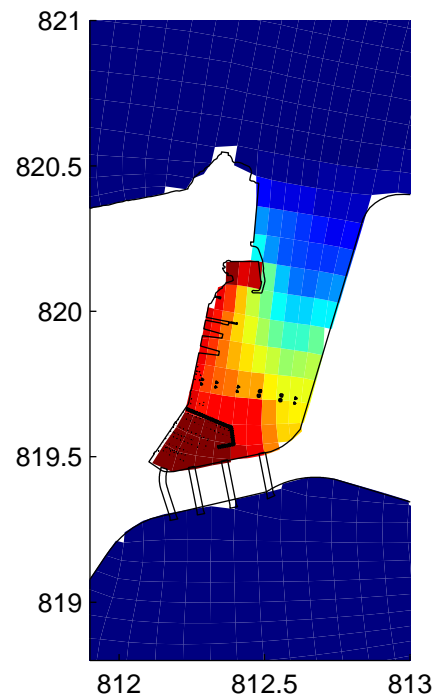
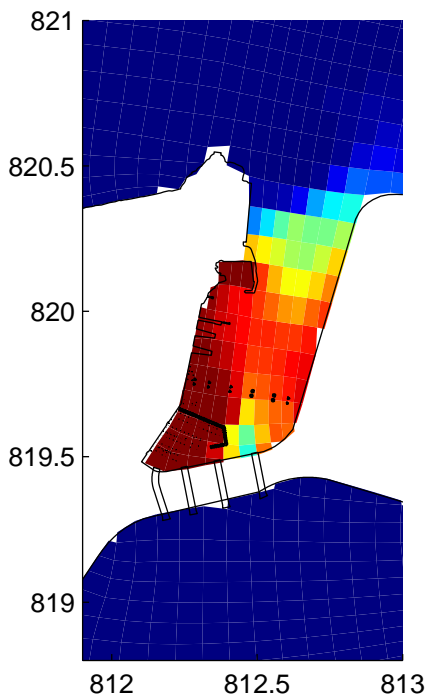
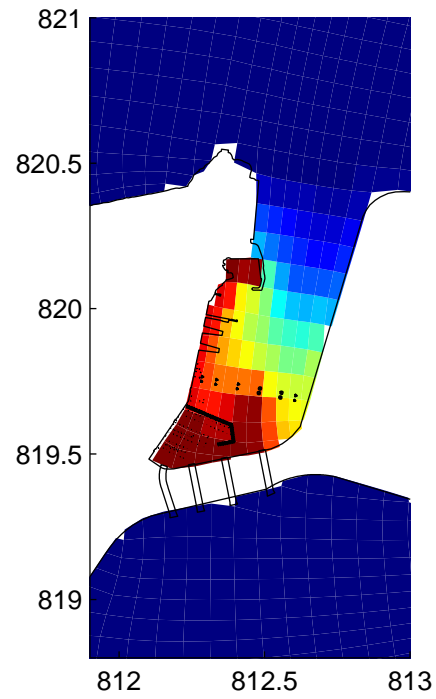
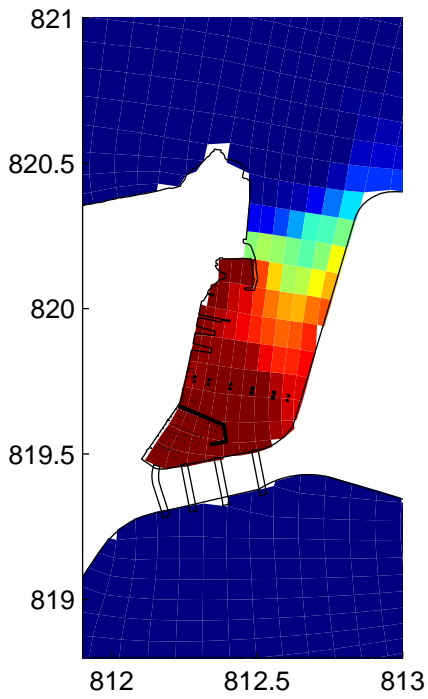

Tracer Concentration During Neap Flood Tide in Dry season at 2hr & 4 hr
 Top: Baseline; Bottom: Project; Left: 2hr; Right: 4hr

0622478

ERM

WQ/Tracer

Tracer₂.fig

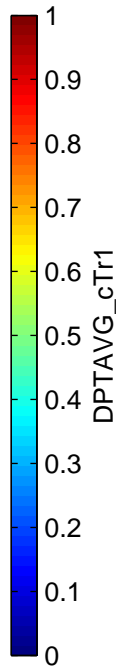
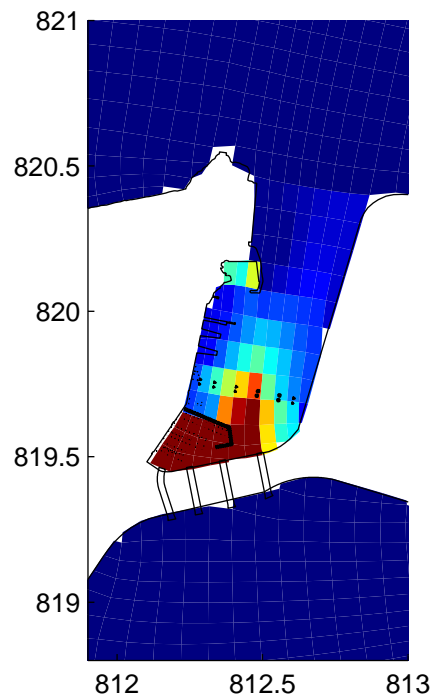
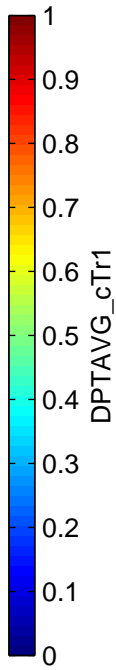
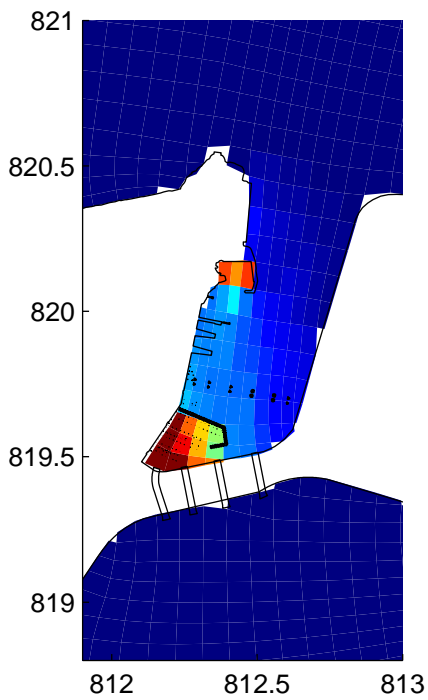
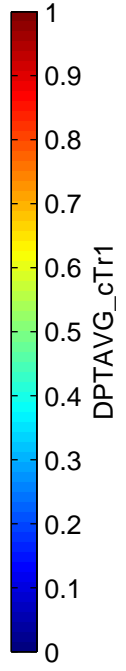
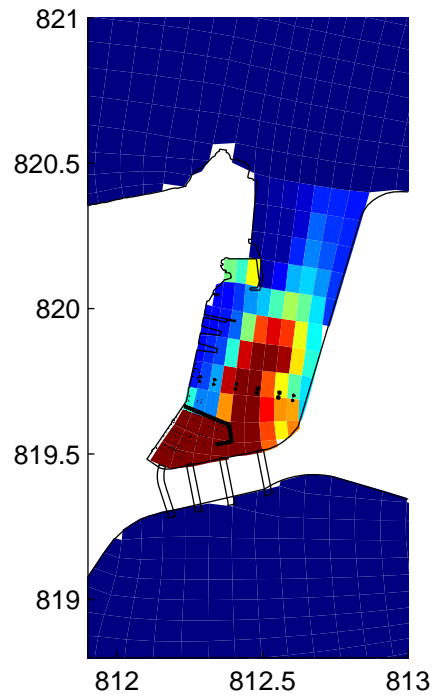
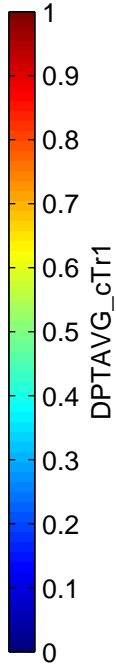
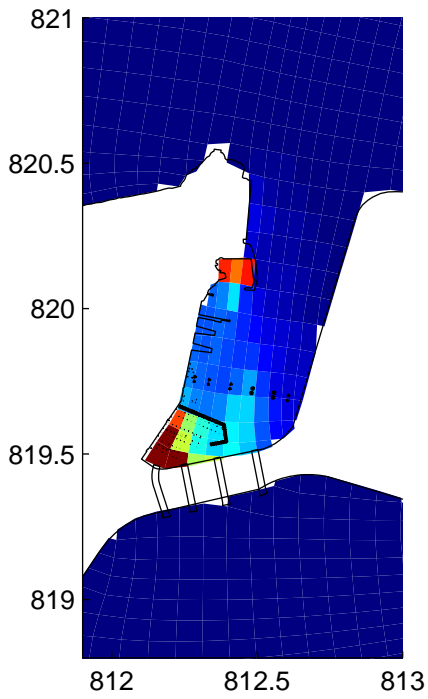

Tracer Concentration During Neap Flood Tide in Dry season at 8hr & 12 hr
 Top: Baseline; Bottom: Project; Left: 8hr; Right: 12hr

0622478

ERM

WQ/Tracer

Tracer₂.fig

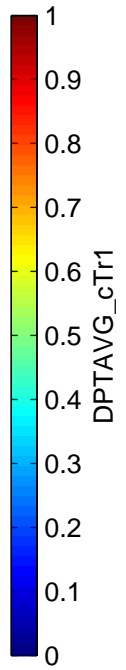
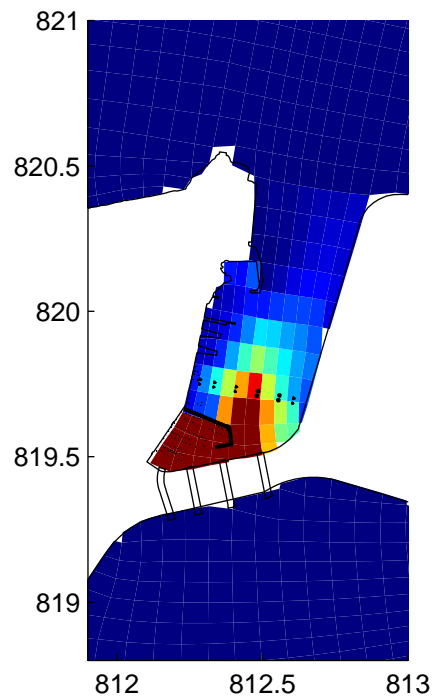
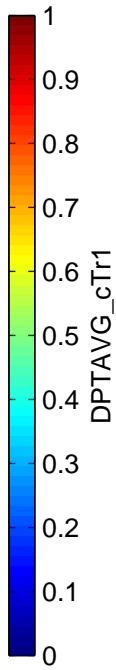
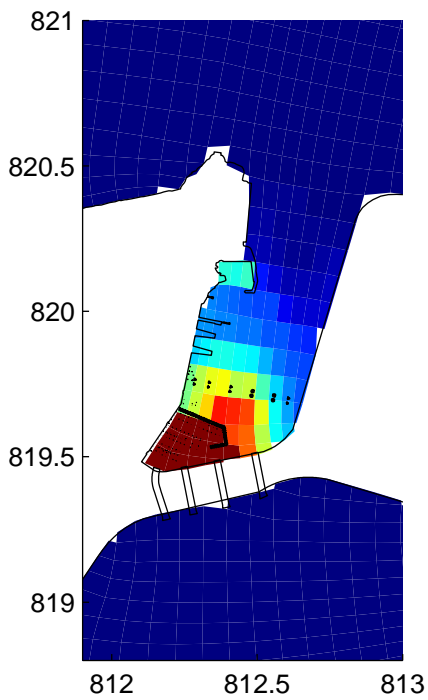
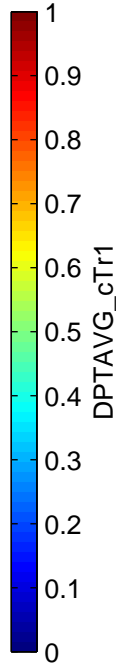
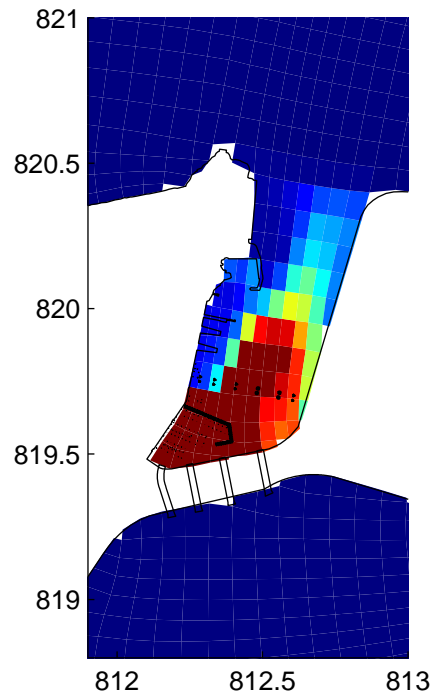
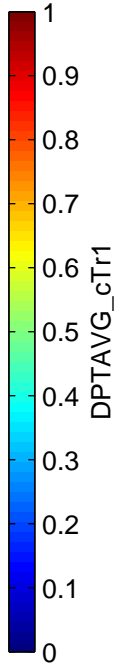
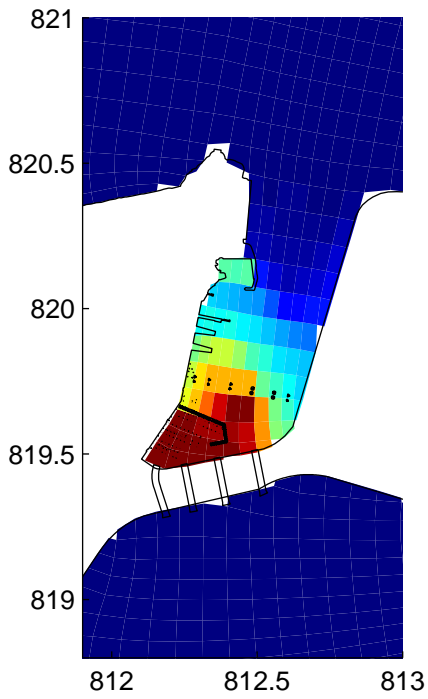

Tracer Concentration During Neap Flood Tide in Dry season at 16hr & 24 hr
 Top: Baseline; Bottom: Project; Left: 16hr; Right: 24hr

0622478

ERM

WQ/Tracer

Tracer₂.fig

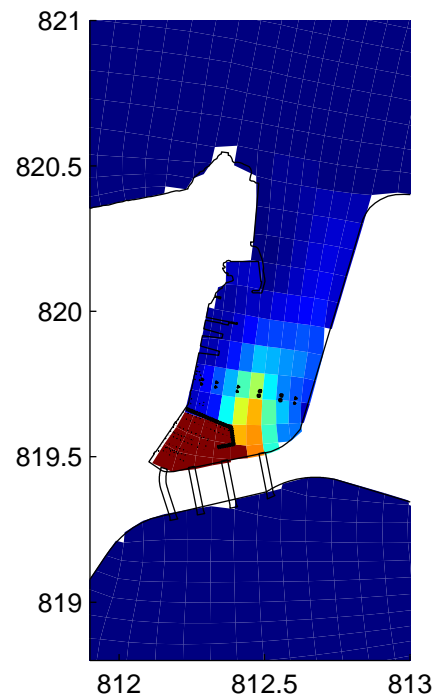
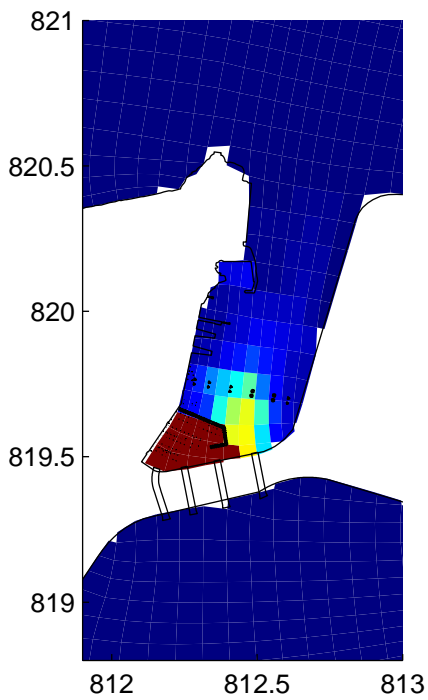
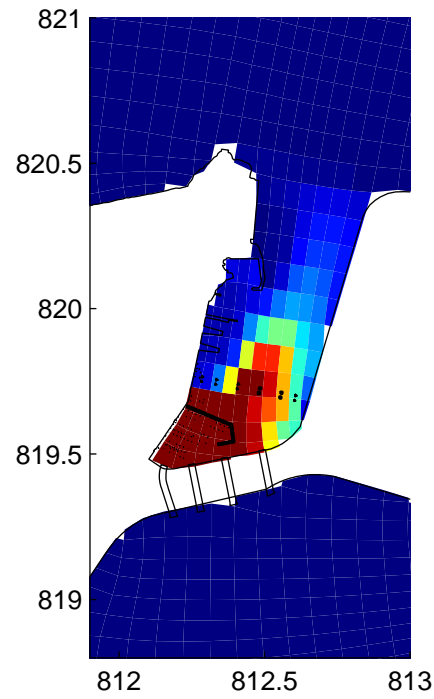
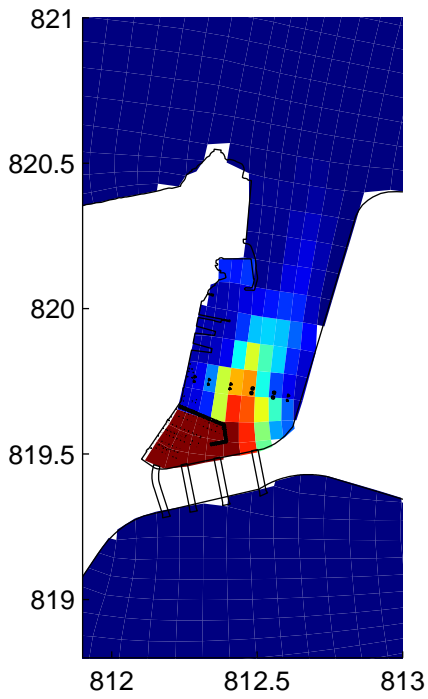

Tracer Concentration During Neap Flood Tide in Dry season at 36hr & 48 hr
 Top: Baseline; Bottom: Project; Left: 36hr; Right: 48hr

0622478

ERM

WQ/Tracer

Tracer₂.fig

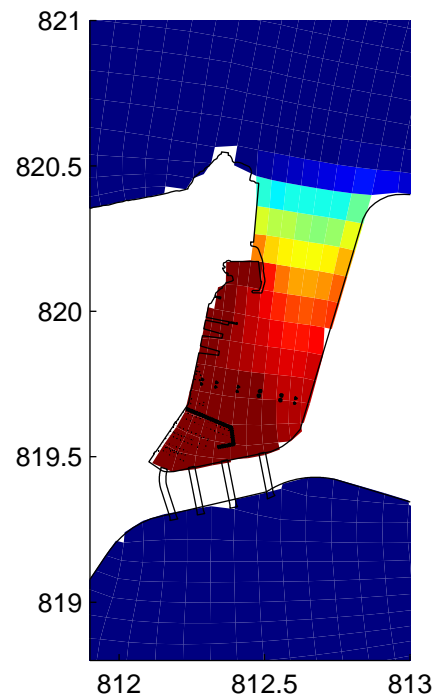
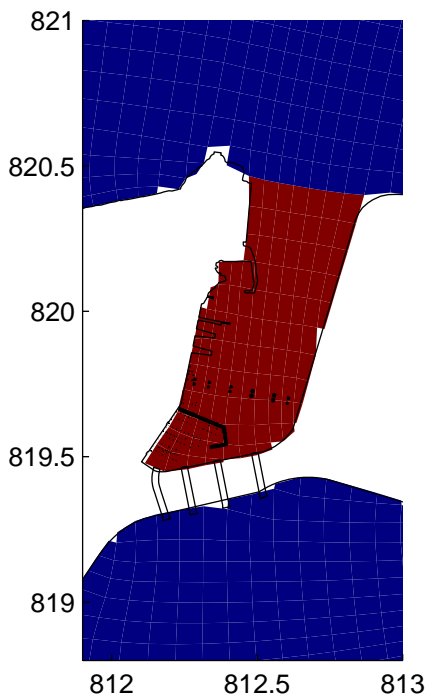
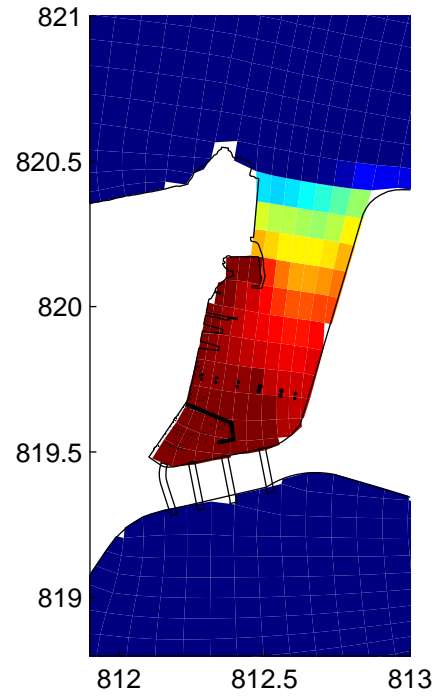
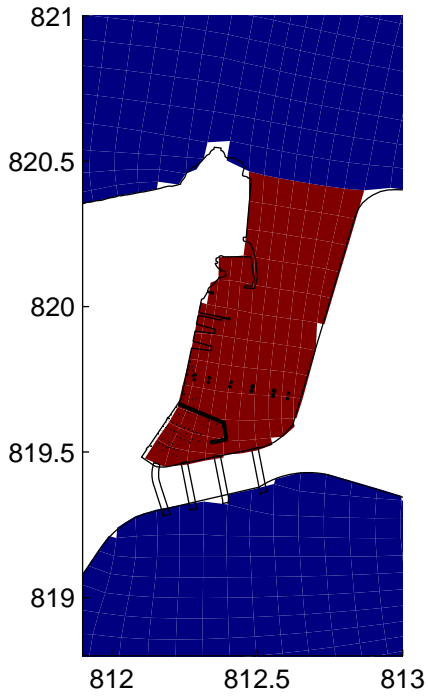

Tracer Concentration During Neap High Water in Dry season at 0hr & 1 hr
 Top: Baseline; Bottom: Project; Left: 0hr; Right: 1hr

0622478

ERM

WQ/Tracer

Tracer₂.fig

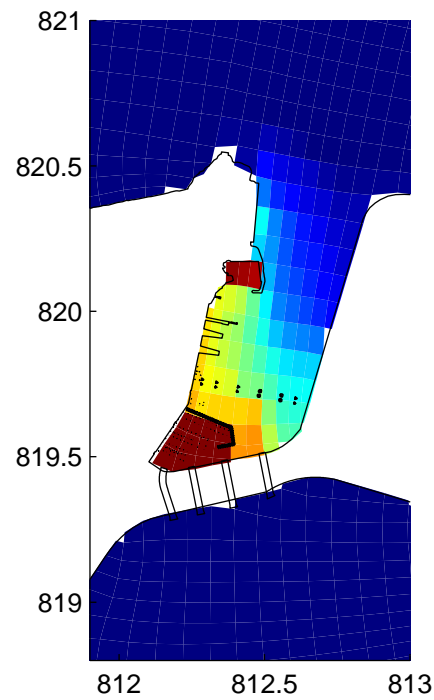
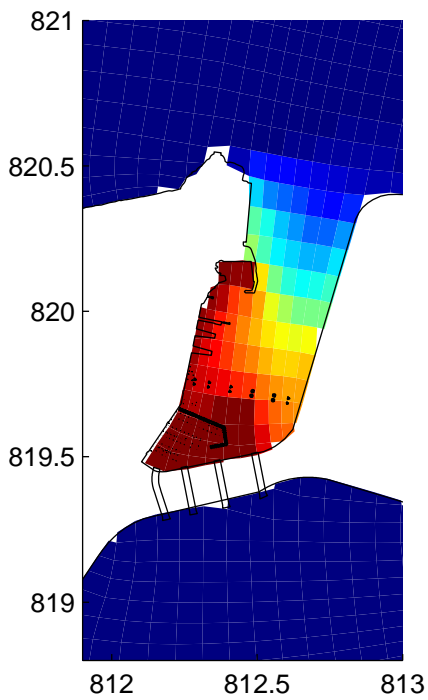
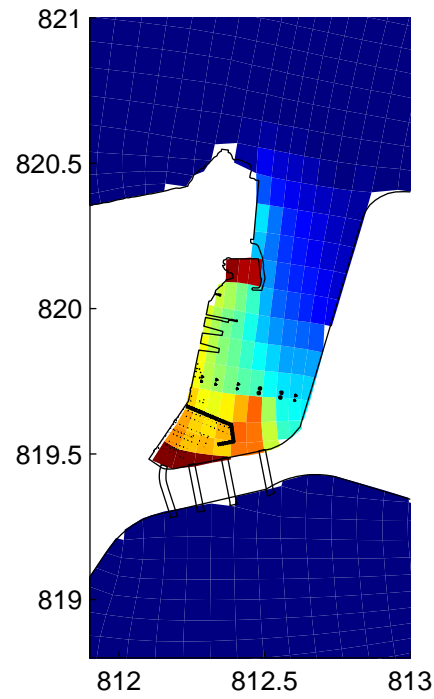
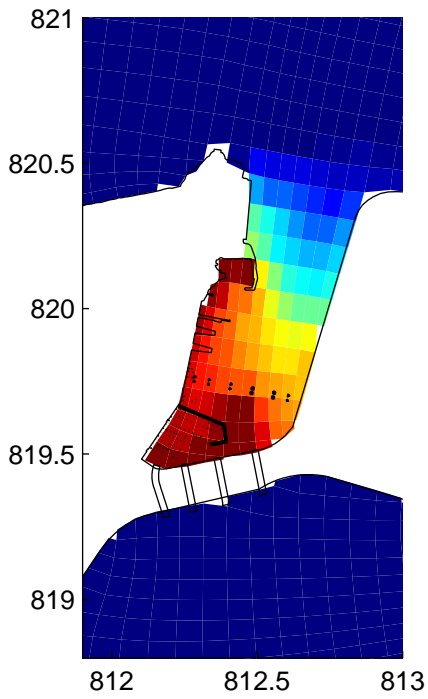

Tracer Concentration During Neap High Water in Dry season at 2hr & 4 hr
 Top: Baseline; Bottom: Project; Left: 2hr; Right: 4hr

0622478

ERM

WQ/Tracer

Tracer₂.fig

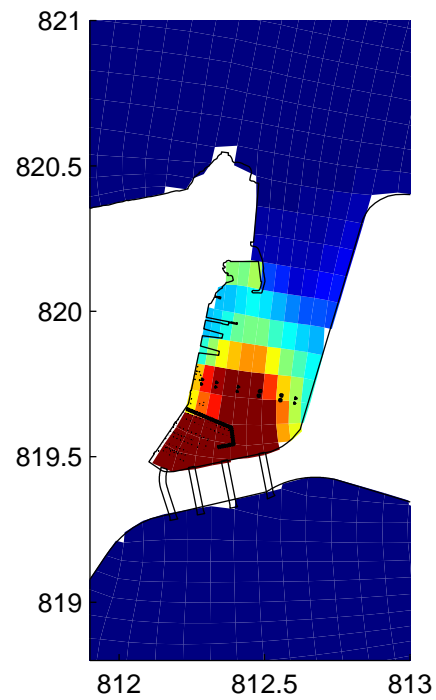
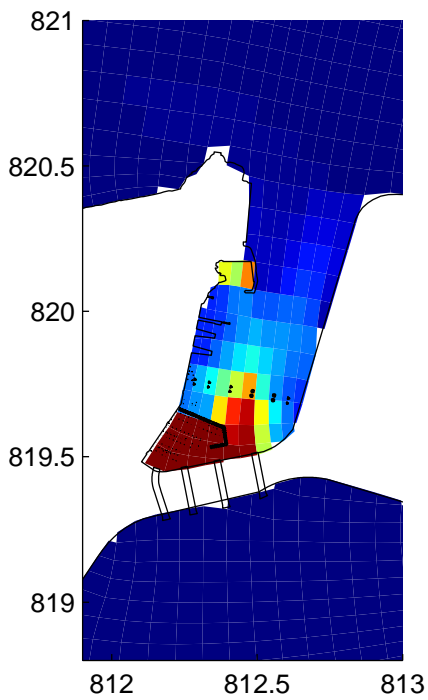
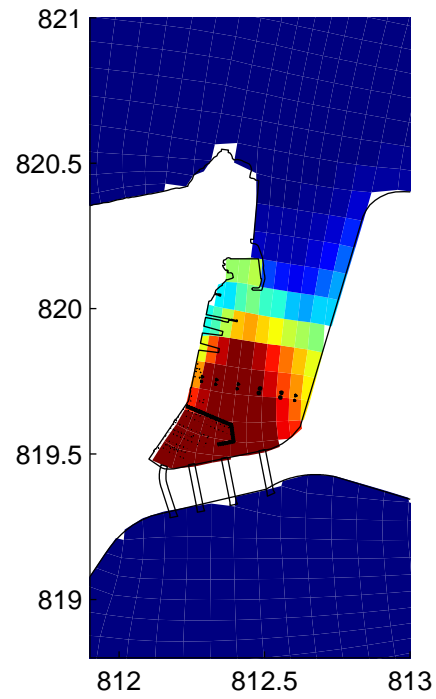
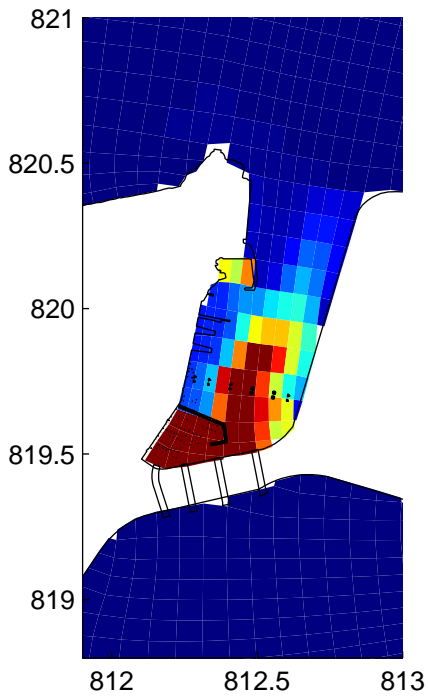

Tracer Concentration During Neap High Water in Dry season at 8hr & 12 hr
 Top: Baseline; Bottom: Project; Left: 8hr; Right: 12hr

0622478

ERM

WQ/Tracer

Tracer₂.fig

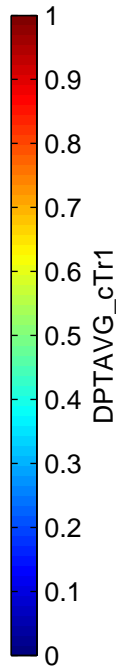
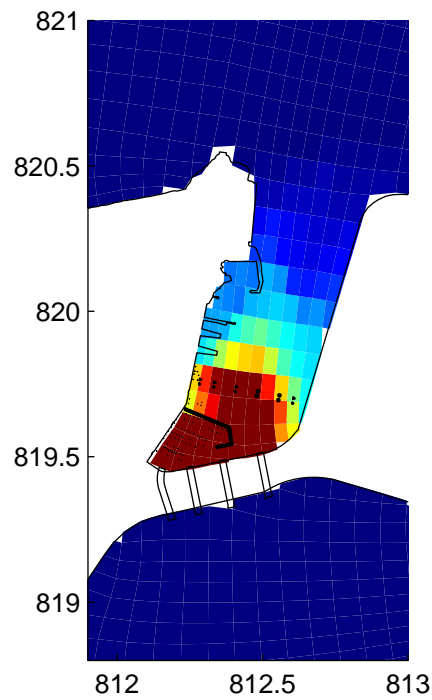
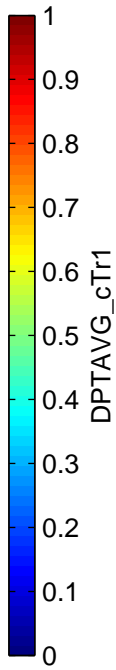
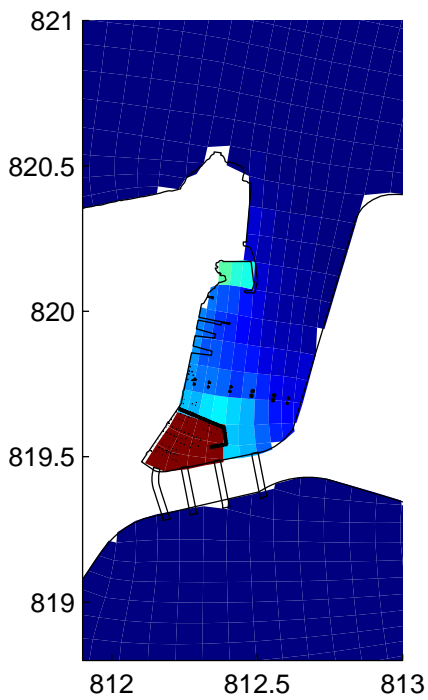
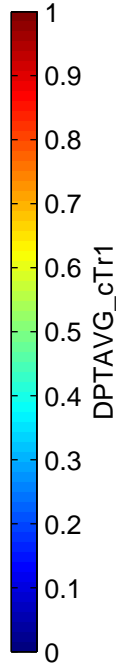
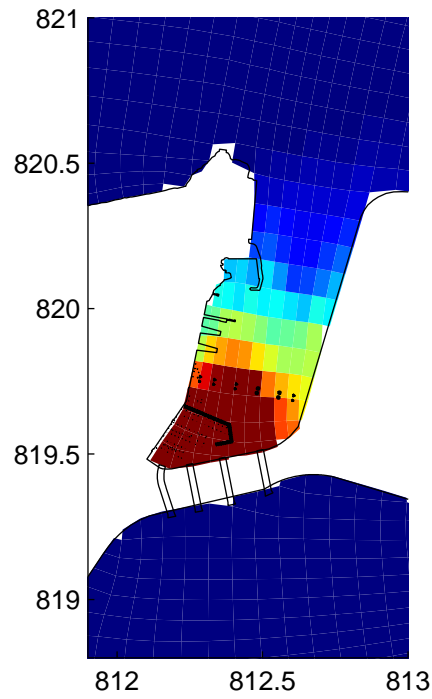
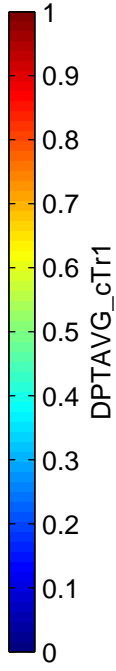
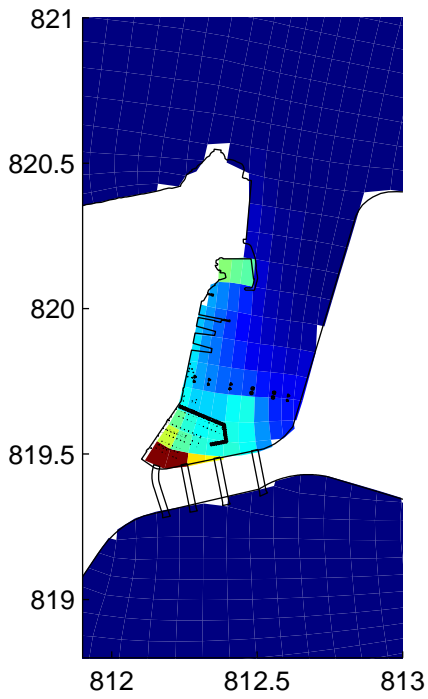

Tracer Concentration During Neap High Water in Dry season at 16hr & 24 hr
 Top: Baseline; Bottom: Project; Left: 16hr; Right: 24hr

0622478

ERM

WQ/Tracer

Tracer₂.fig

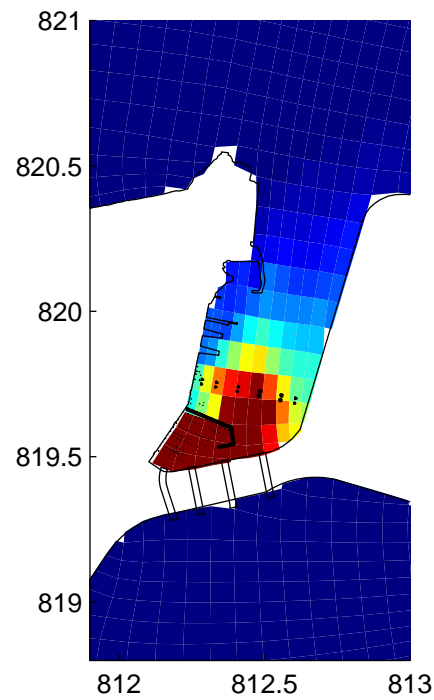
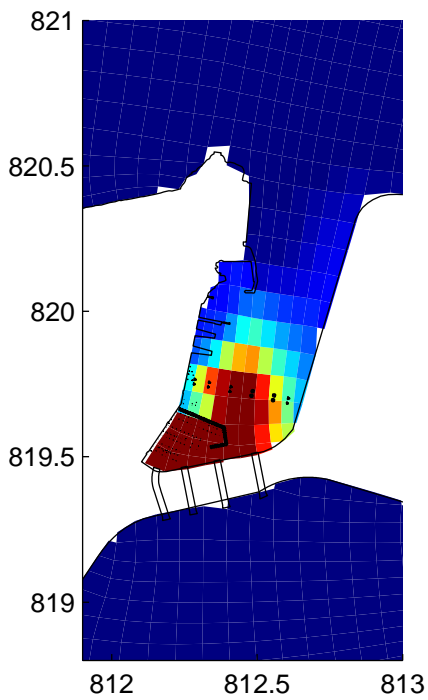
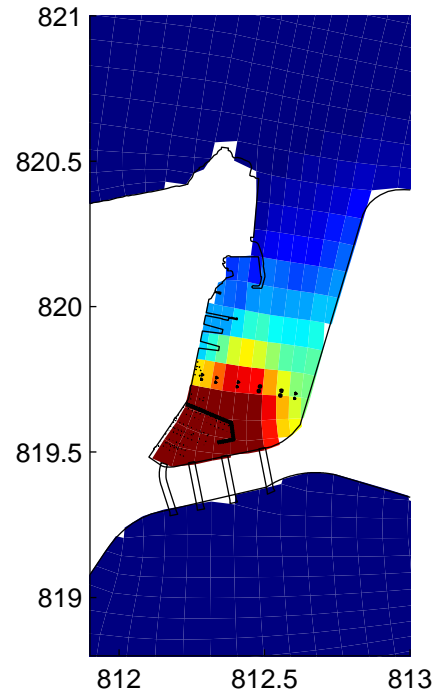
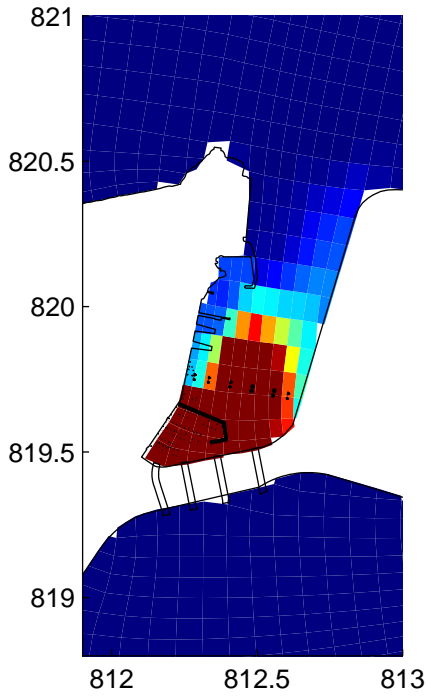

Tracer Concentration During Neap High Water in Dry season at 36hr & 48 hr
 Top: Baseline; Bottom: Project; Left: 36hr; Right: 48hr

0622478

ERM

WQ/Tracer

Tracer₂.fig

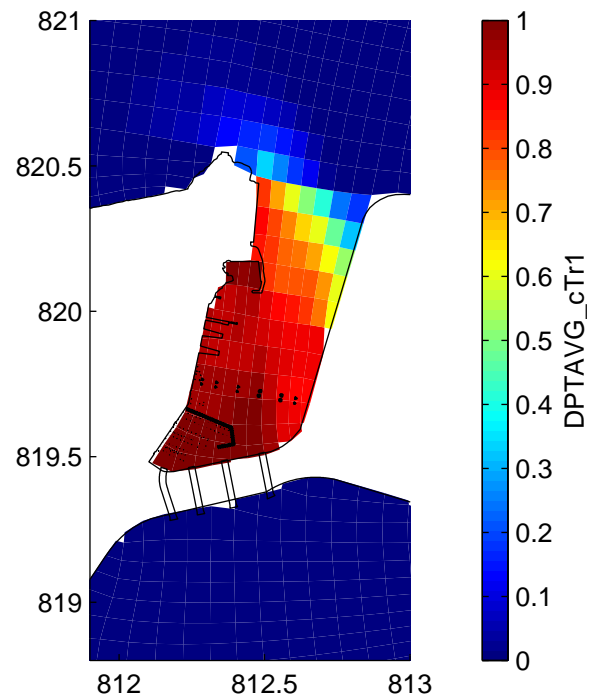
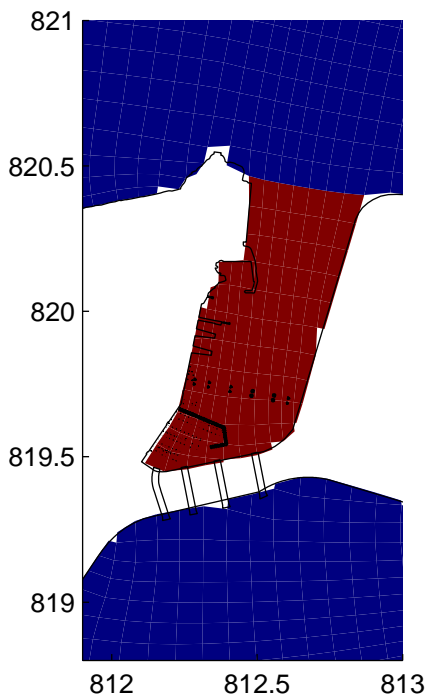
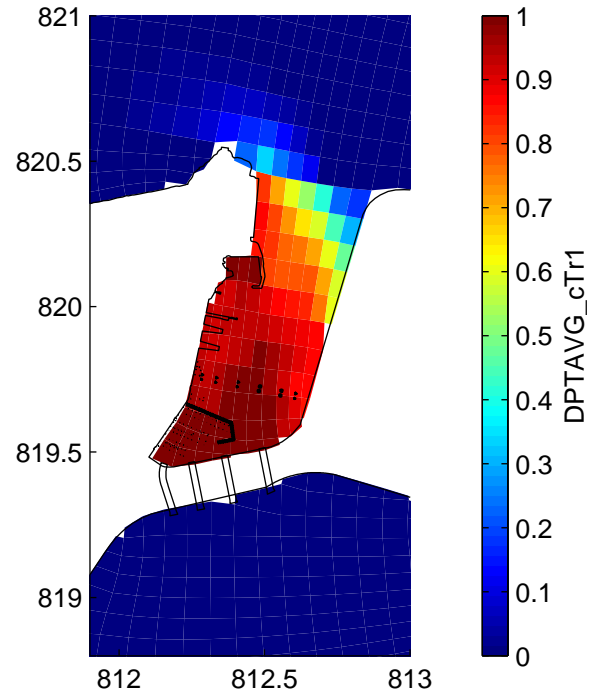
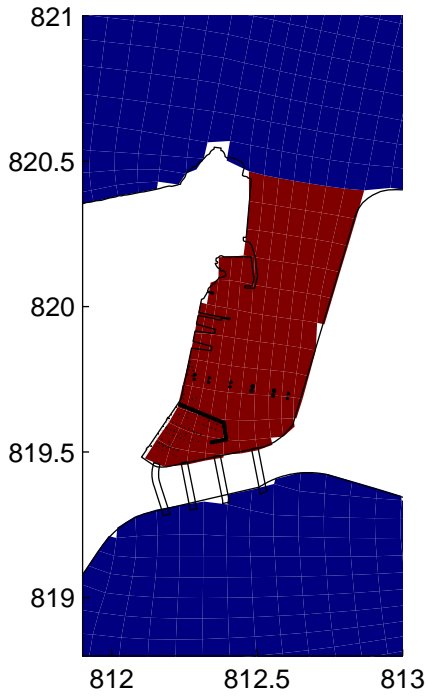

Tracer Concentration During Neap Low Water in Dry season at 0hr & 1 hr
 Top: Baseline; Bottom: Project; Left: 0hr; Right: 1hr

0622478

ERM

WQ/Tracer

Tracer₂.fig

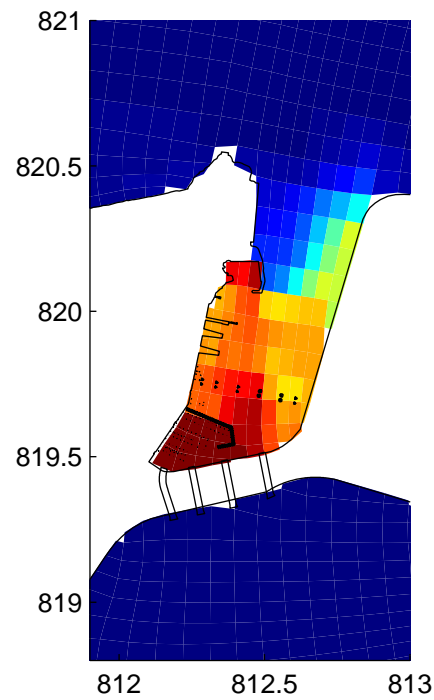
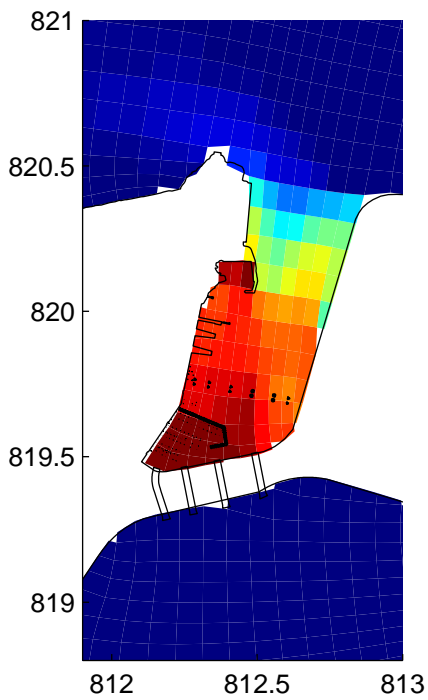
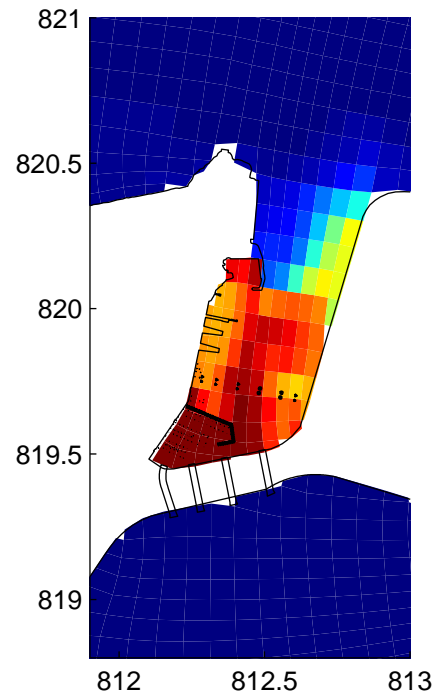
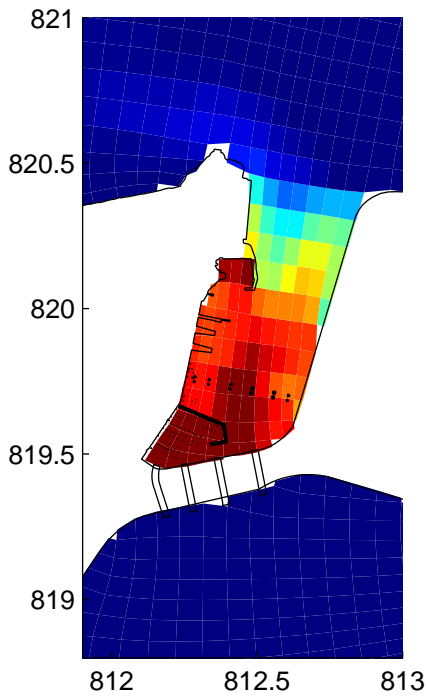

Tracer Concentration During Neap Low Water in Dry season at 2hr & 4 hr
 Top: Baseline; Bottom: Project; Left: 2hr; Right: 4hr

0622478

ERM

WQ/Tracer

Tracer₂.fig

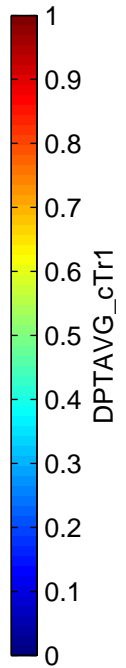
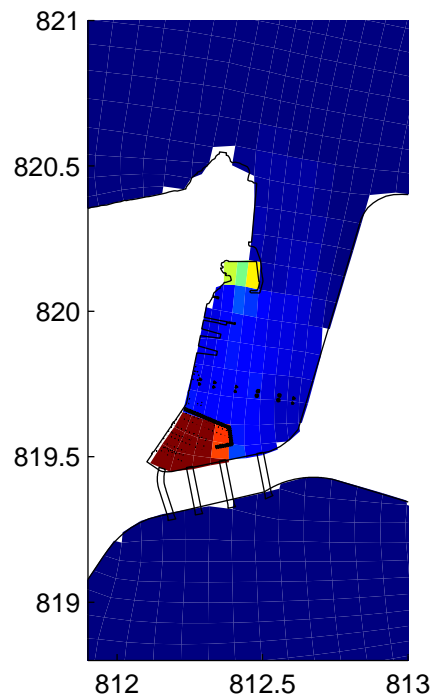
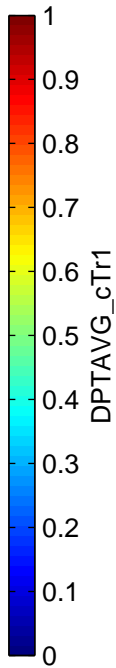
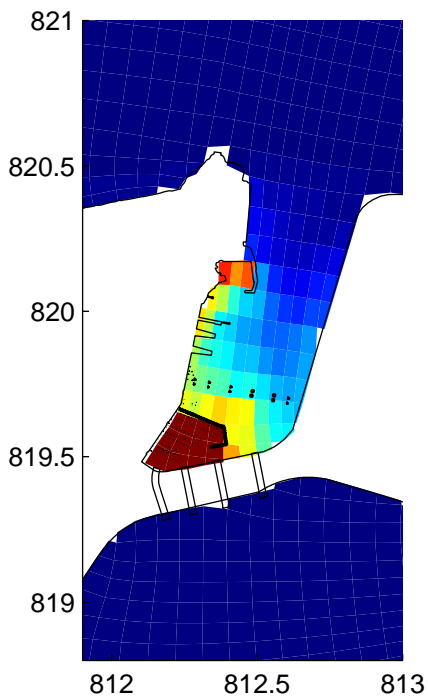
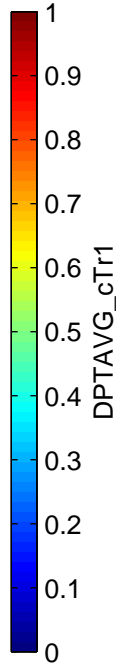
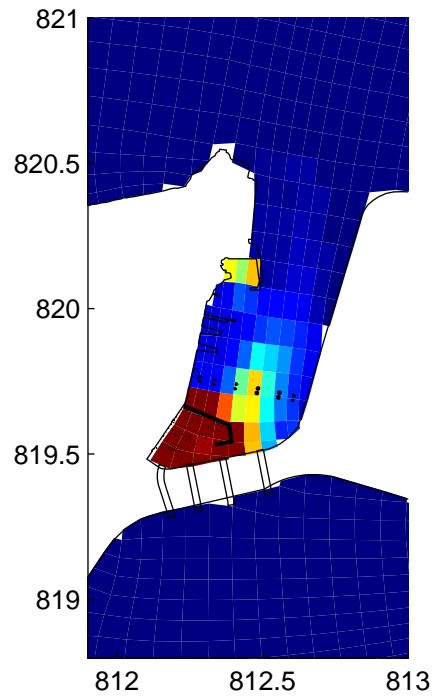
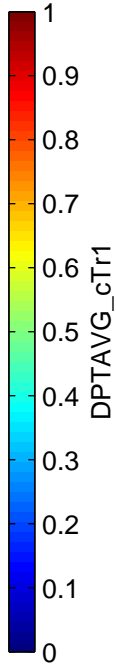
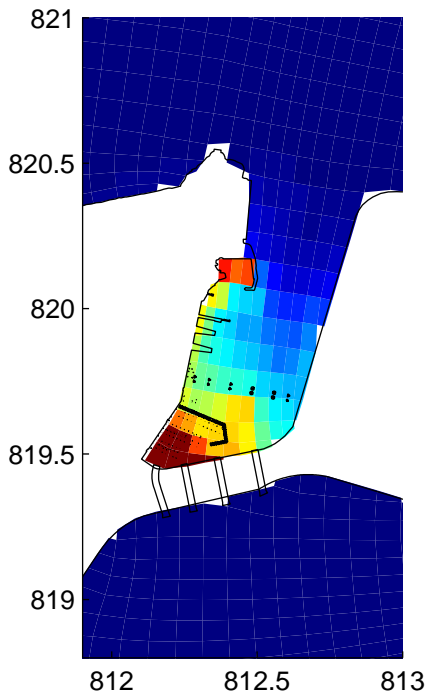

Tracer Concentration During Neap Low Water in Dry season at 8hr & 12 hr
 Top: Baseline; Bottom: Project; Left: 8hr; Right: 12hr

0622478

ERM

WQ/Tracer

Tracer₂.fig

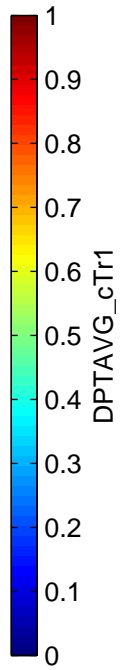
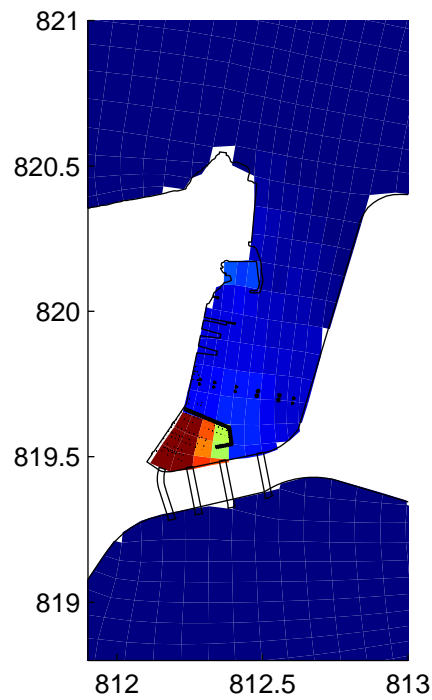
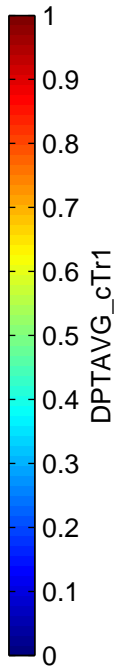
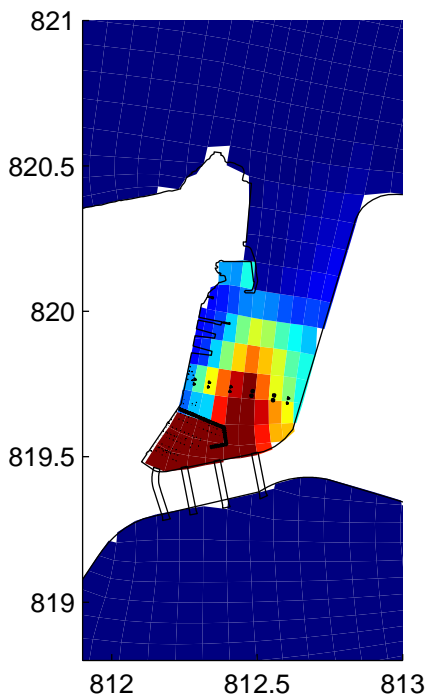
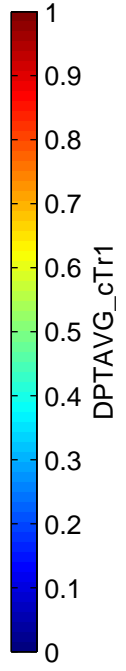
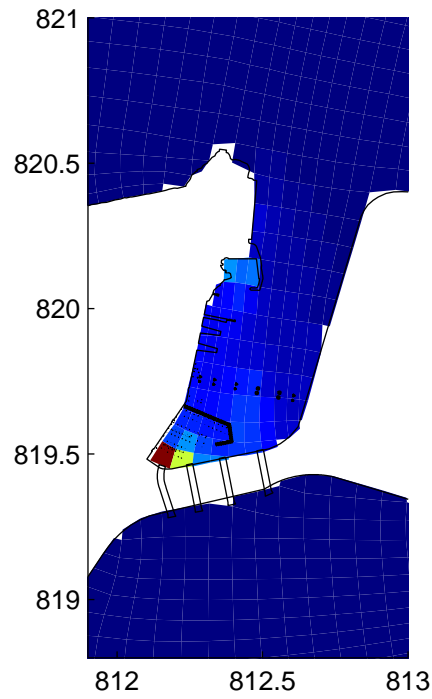
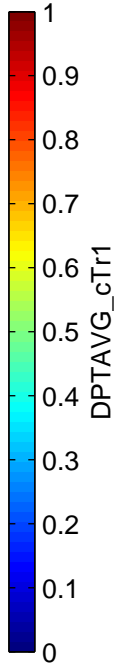
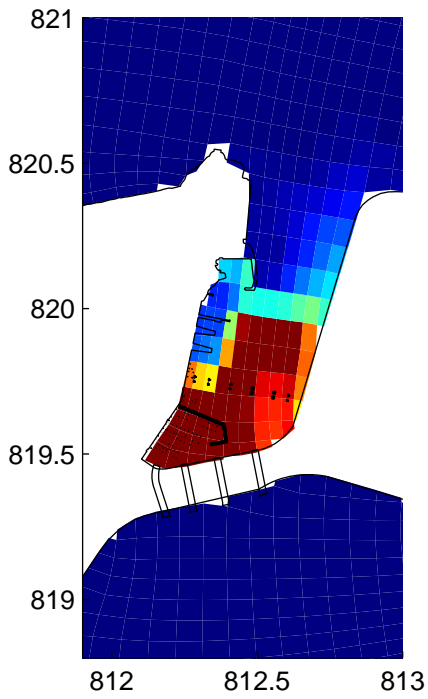

Tracer Concentration During Neap Low Water in Dry season at 16hr & 24 hr
 Top: Baseline; Bottom: Project; Left: 16hr; Right: 24hr

0622478

ERM

WQ/Tracer

Tracer₂.fig

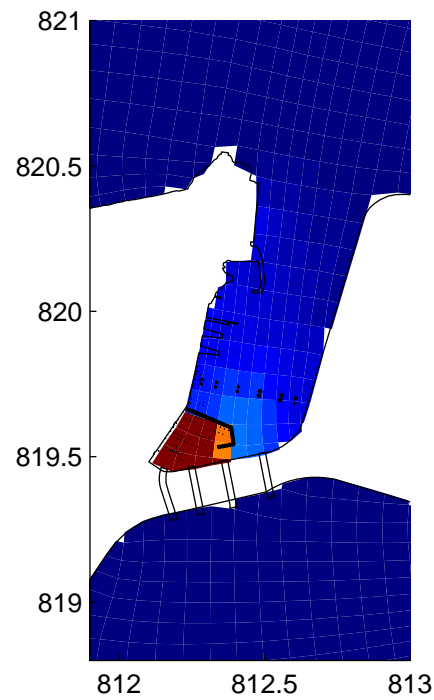
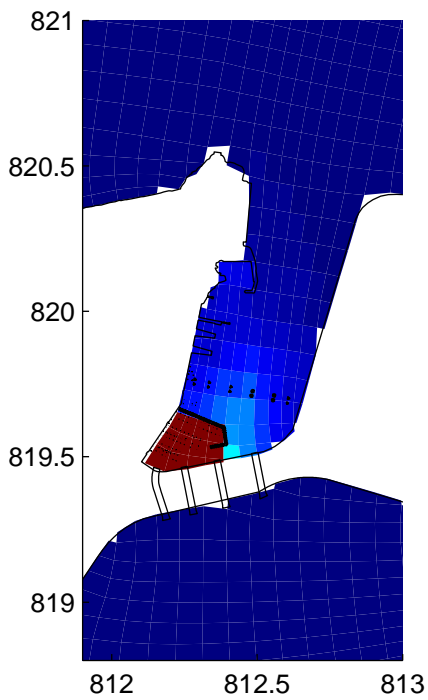
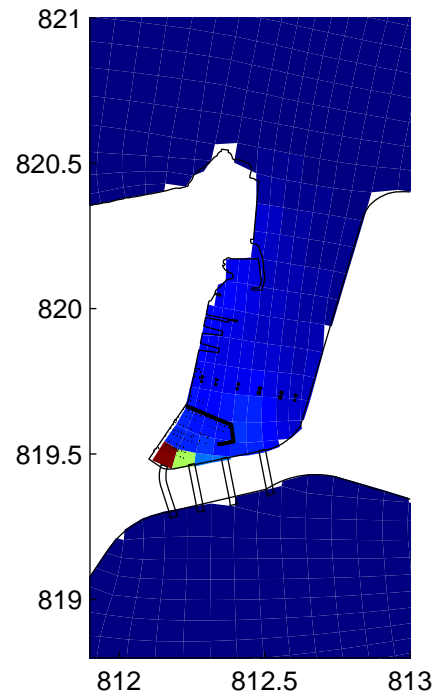
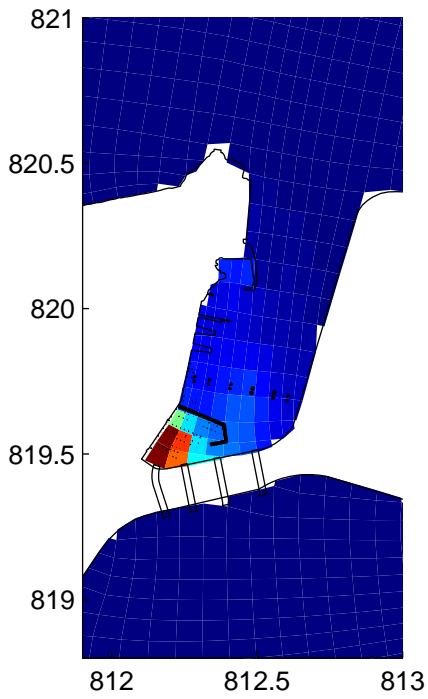

Tracer Concentration During Neap Low Water in Dry season at 36hr & 48 hr
 Top: Baseline; Bottom: Project; Left: 36hr; Right: 48hr

0622478

ERM

WQ/Tracer

Tracer₂.fig

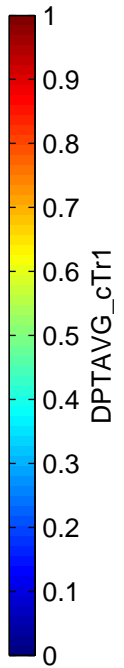
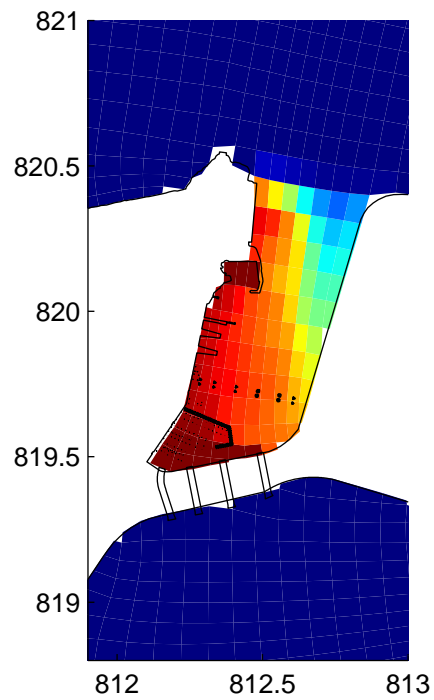
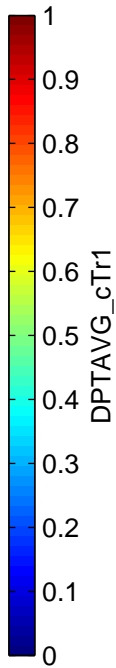
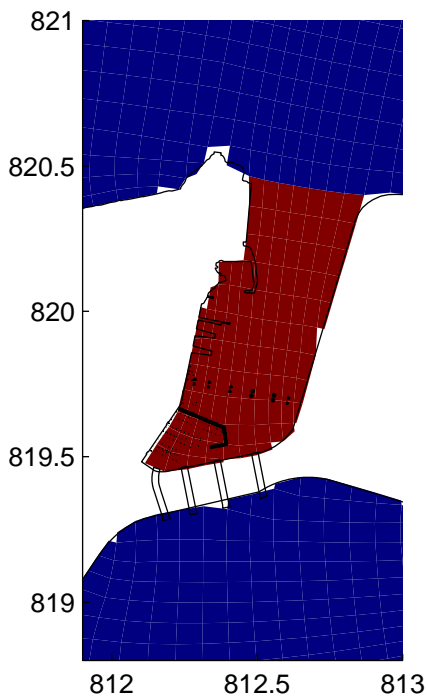
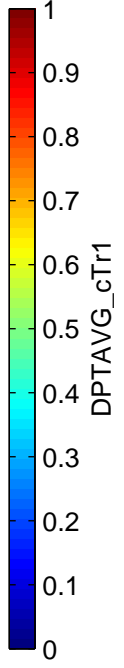
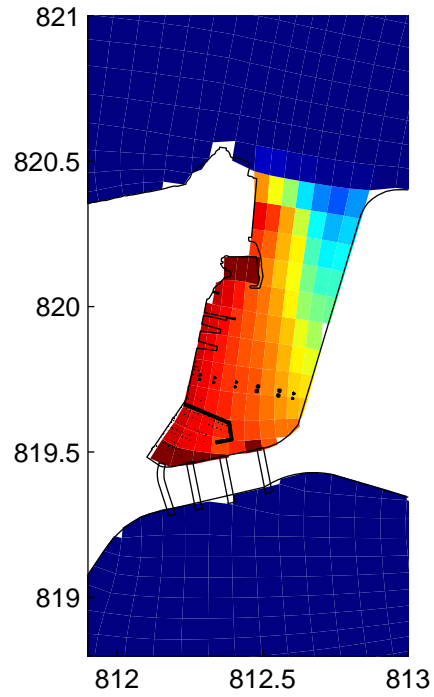
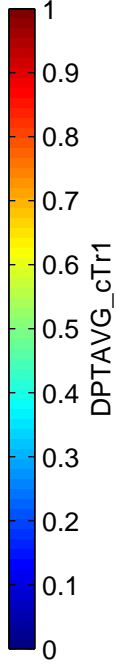
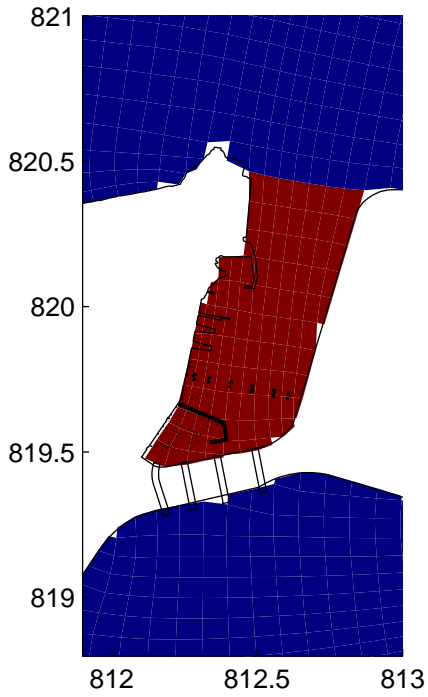

Tracer Concentration During Spring Ebb Tide in Dry season at 0hr & 1 hr
 Top: Baseline; Bottom: Project; Left: 0hr; Right: 1hr

0622478

ERM

WQ/Tracer

Tracer₂.fig

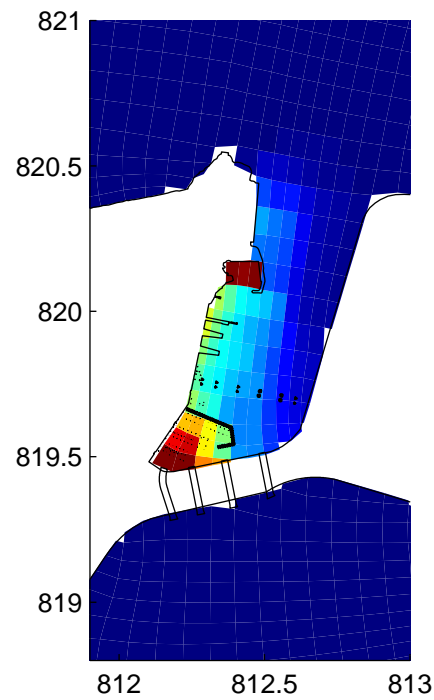
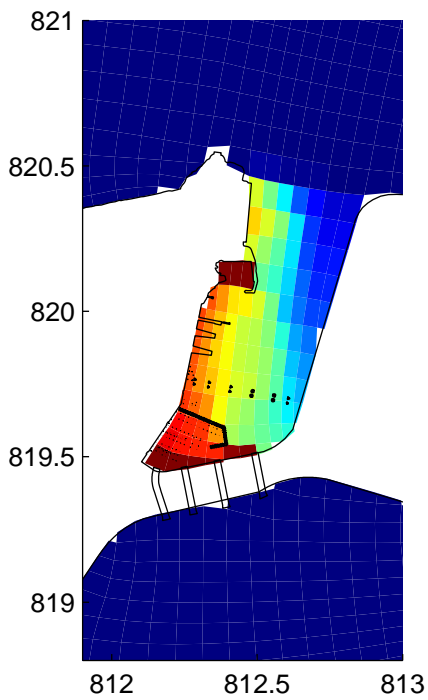
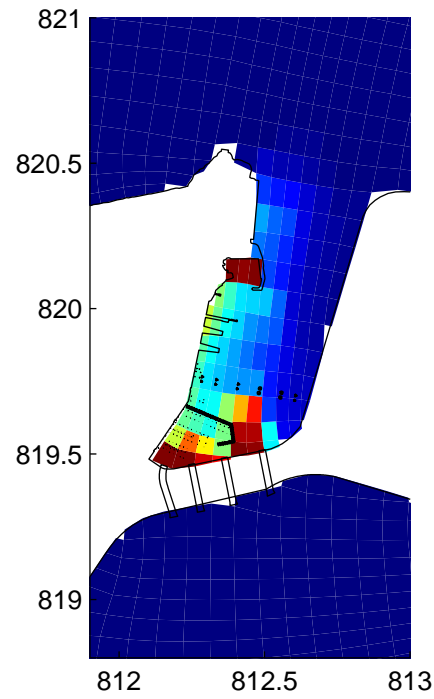
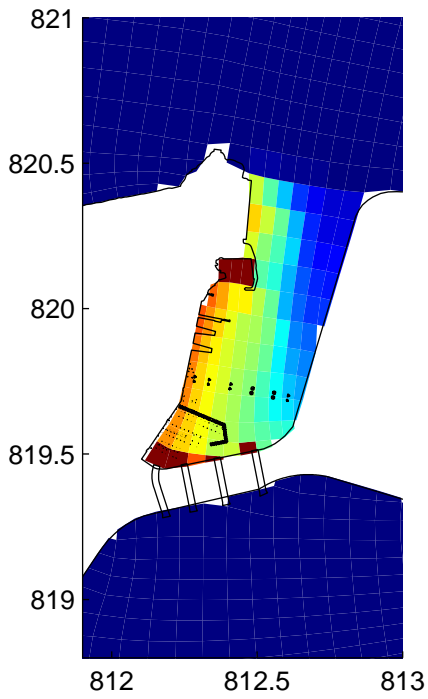

Tracer Concentration During Spring Ebb Tide in Dry season at 2hr & 4 hr
 Top: Baseline; Bottom: Project; Left: 2hr; Right: 4hr

0622478

ERM

WQ/Tracer

Tracer₂.fig

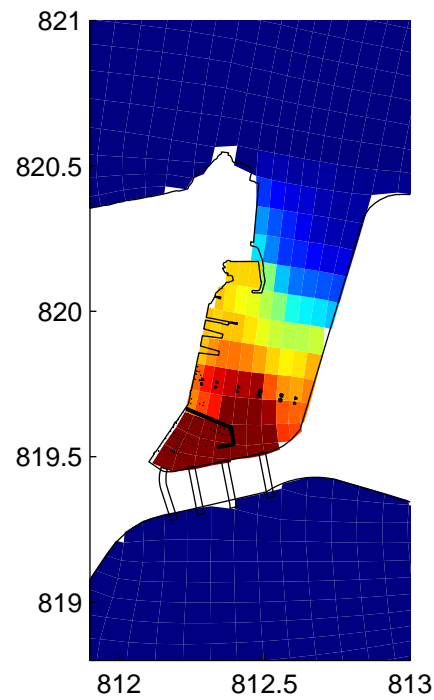
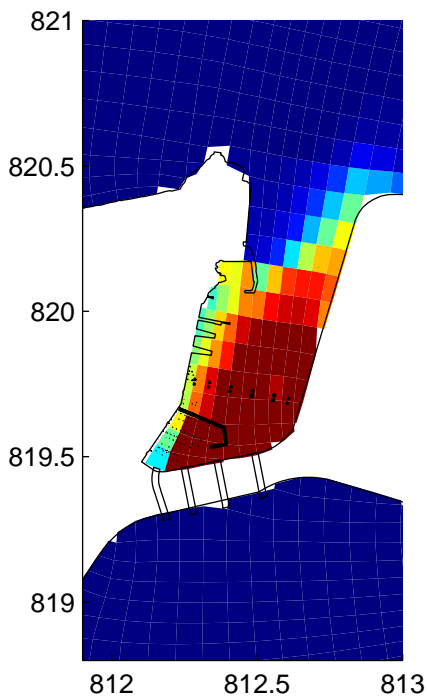
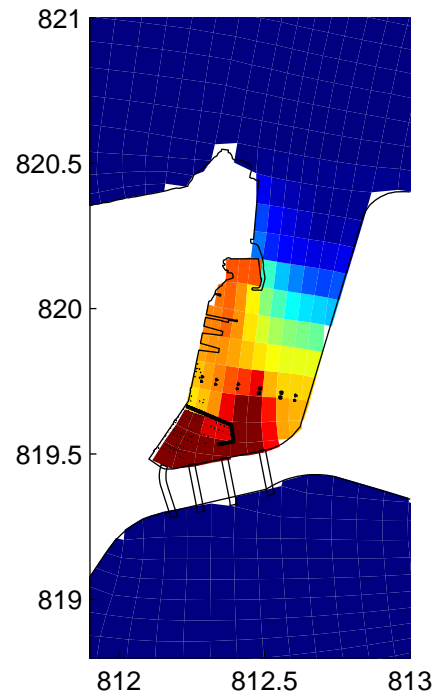
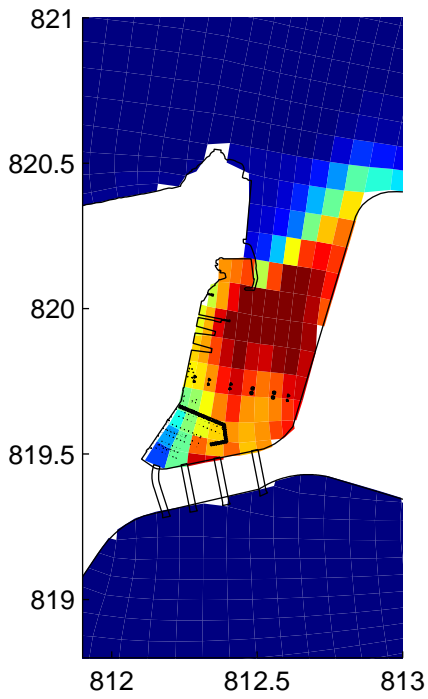

Tracer Concentration During Spring Ebb Tide in Dry season at 8hr & 12 hr
 Top: Baseline; Bottom: Project; Left: 8hr; Right: 12hr

0622478

ERM

WQ/Tracer

Tracer₂.fig

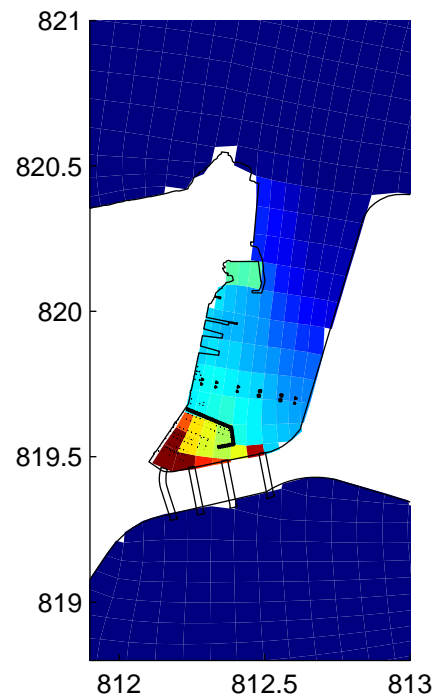
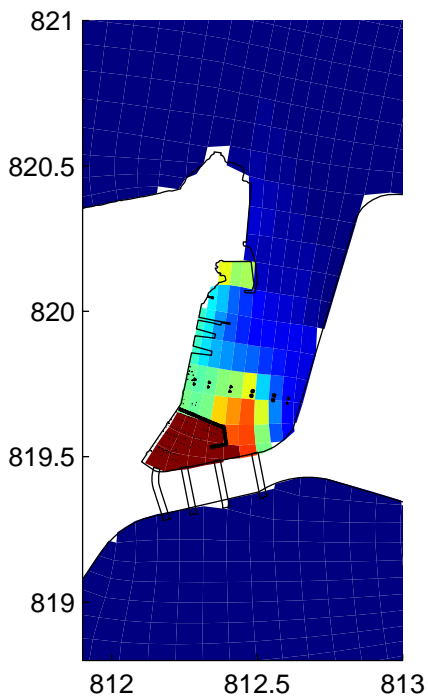
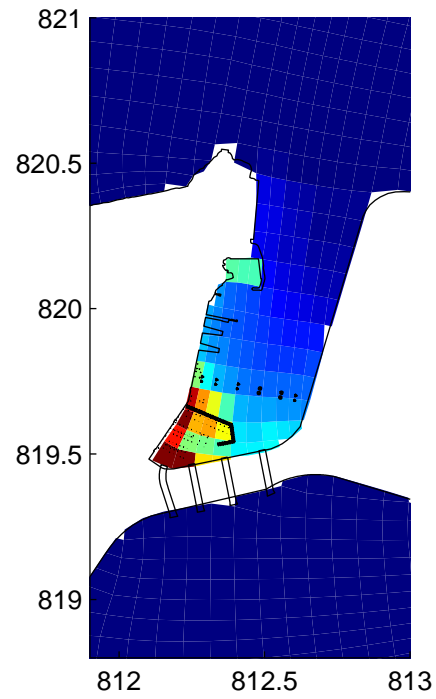
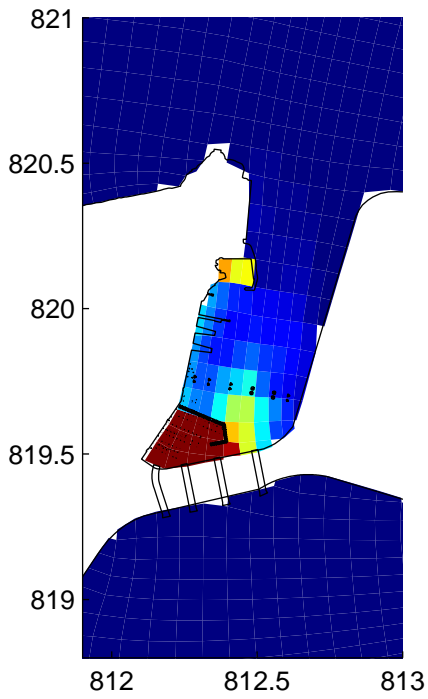

Tracer Concentration During Spring Ebb Tide in Dry season at 16hr & 24 hr
 Top: Baseline; Bottom: Project; Left: 16hr; Right: 24hr

0622478

ERM

WQ/Tracer

Tracer₂.fig

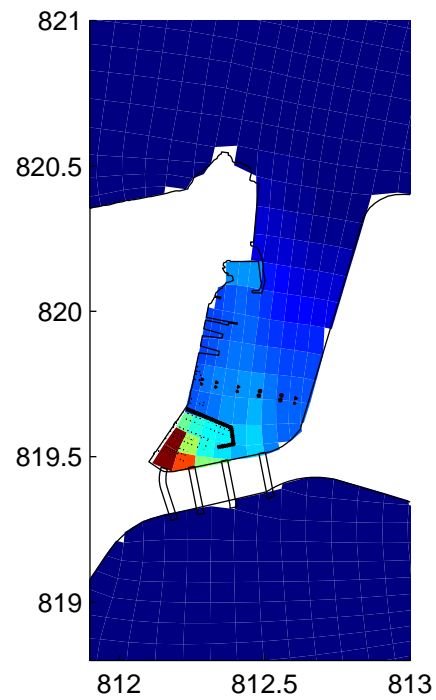
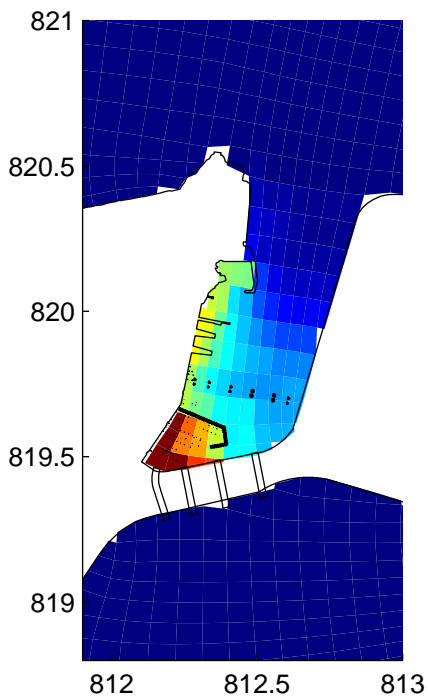
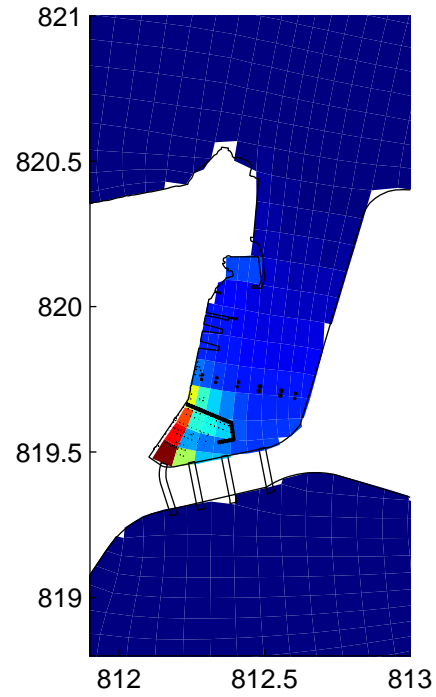
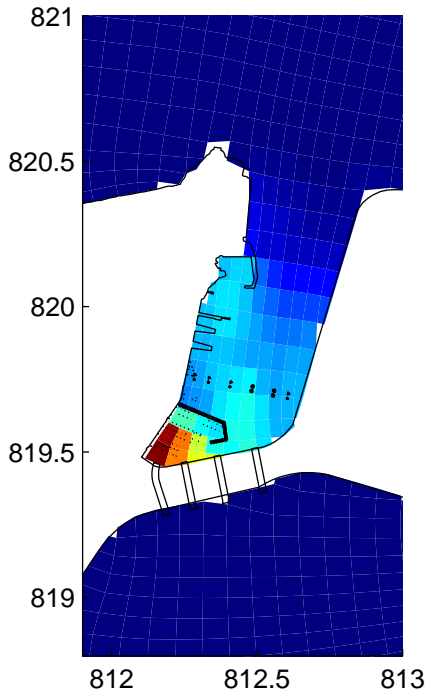

Tracer Concentration During Spring Ebb Tide in Dry season at 36hr & 48 hr
 Top: Baseline; Bottom: Project; Left: 36hr; Right: 48hr

0622478

ERM

WQ/Tracer

Tracer₂.fig

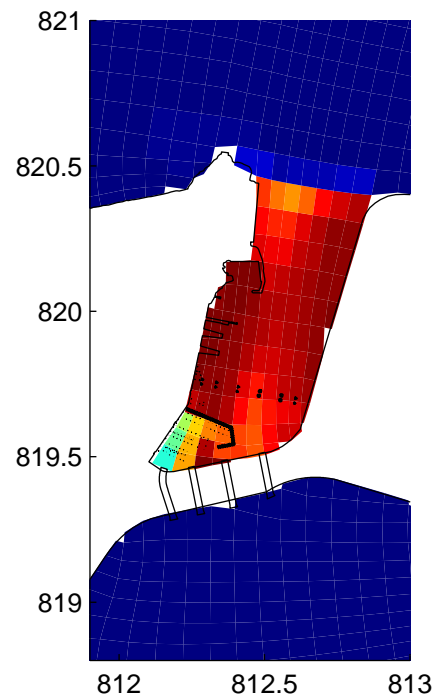
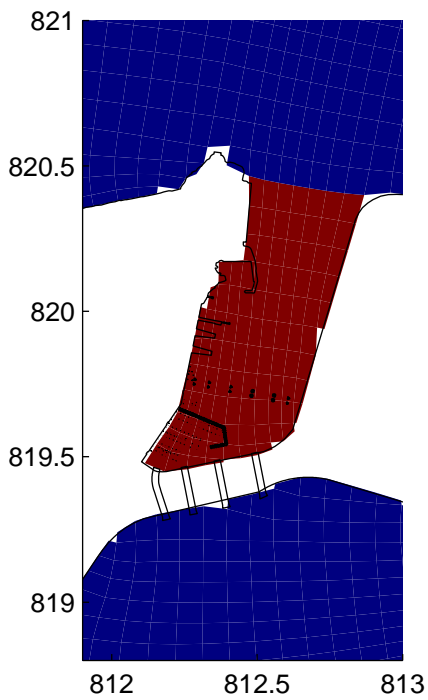
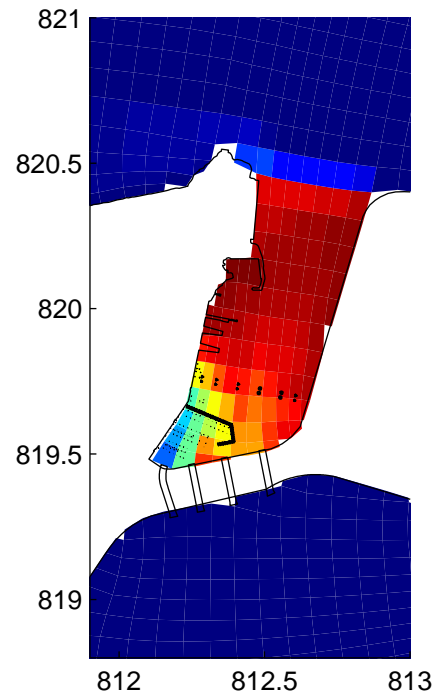
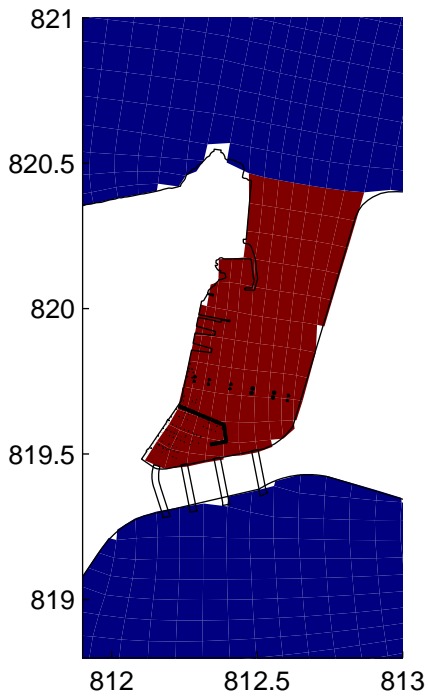

Tracer Concentration During Spring Flood Tide in Dry season at 0hr & 1 hr
 Top: Baseline; Bottom: Project; Left: 0hr; Right: 1hr

0622478

ERM

WQ/Tracer

Tracer₂.fig

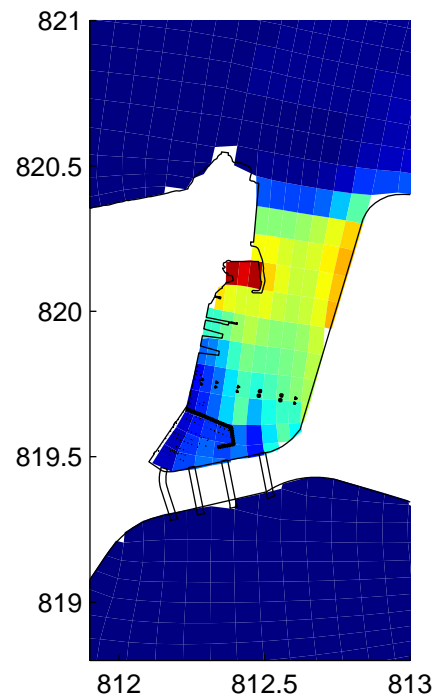
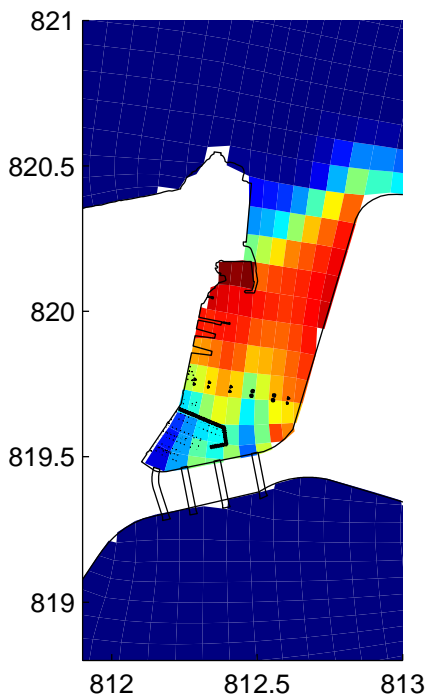
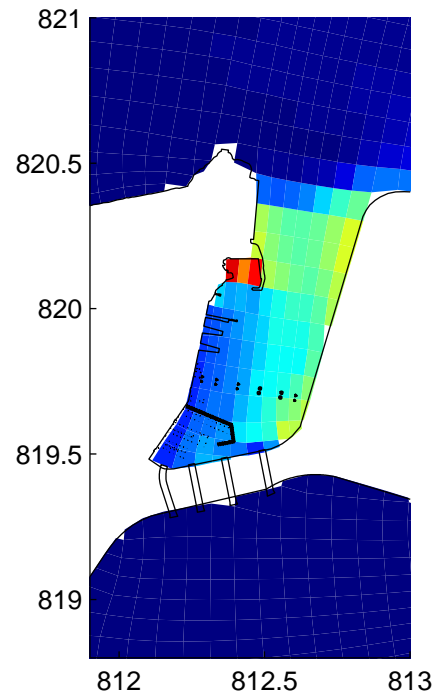
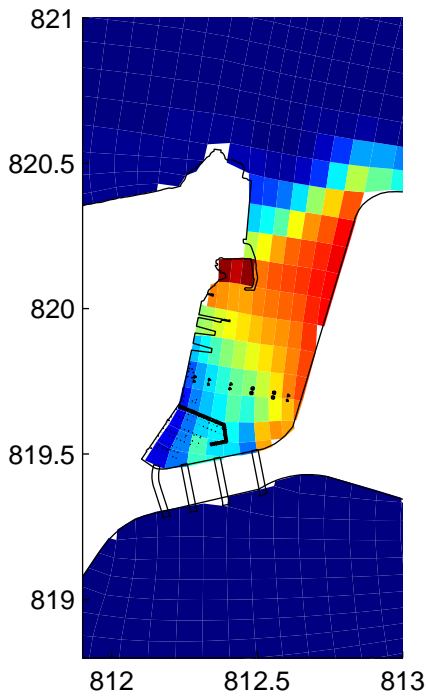

Tracer Concentration During Spring Flood Tide in Dry season at 2hr & 4 hr
 Top: Baseline; Bottom: Project; Left: 2hr; Right: 4hr

0622478

ERM

WQ/Tracer

Tracer₂.fig

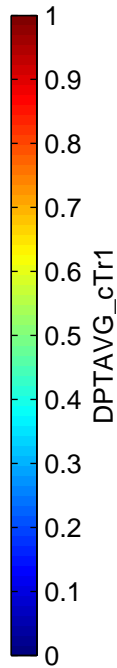
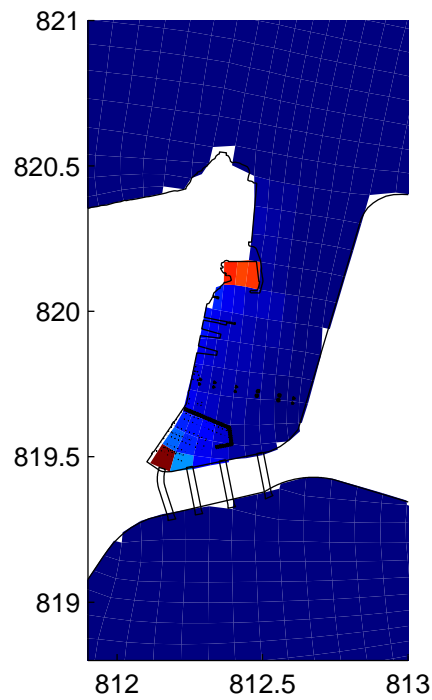
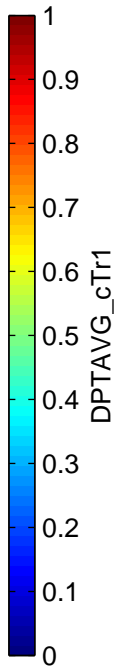
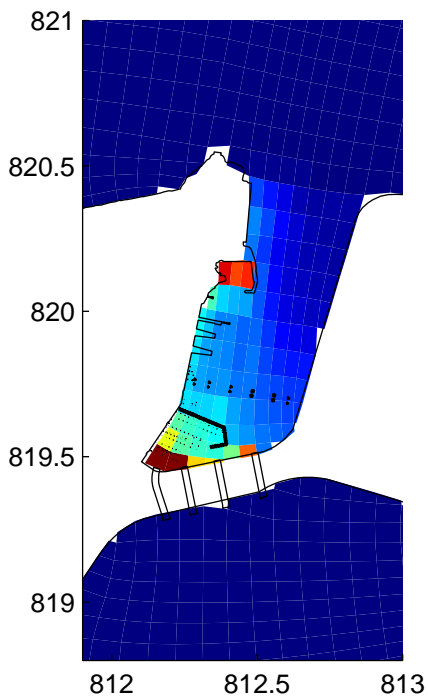
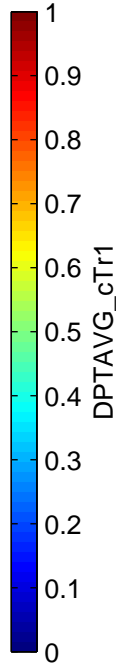
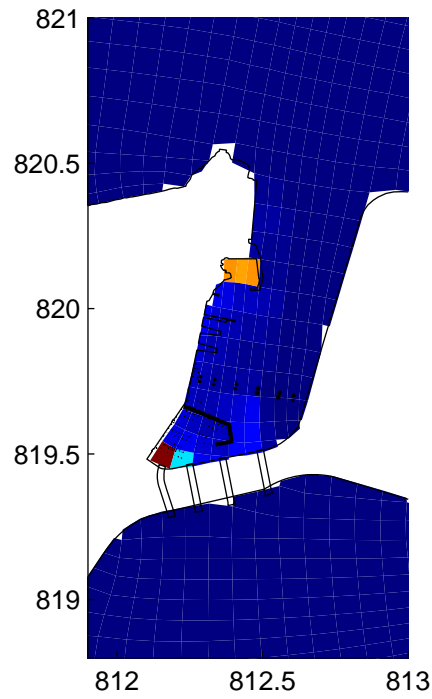
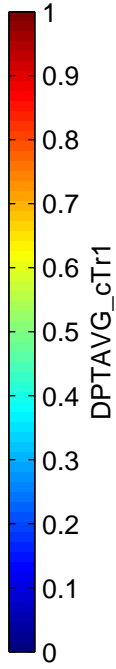
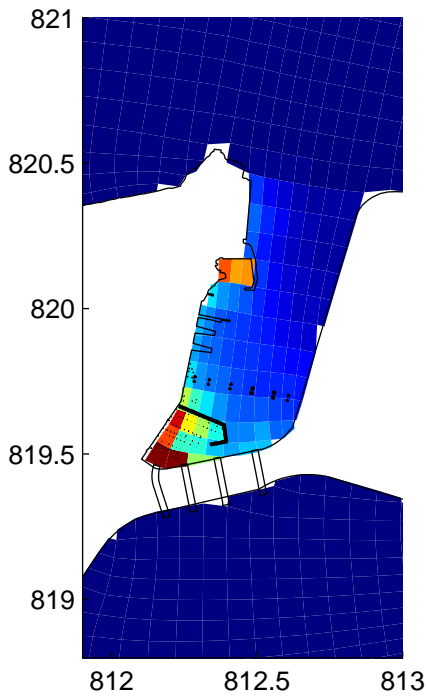

Tracer Concentration During Spring Flood Tide in Dry season at 8hr & 12 hr
 Top: Baseline; Bottom: Project; Left: 8hr; Right: 12hr

0622478

ERM

WQ/Tracer

Tracer₂.fig

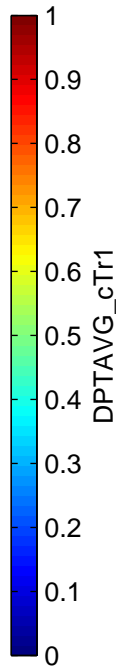
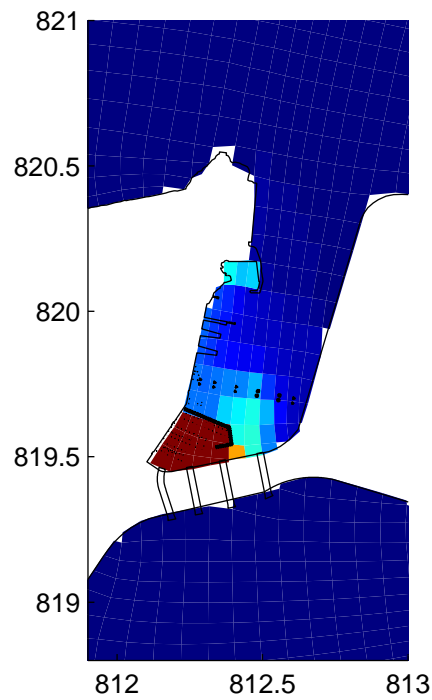
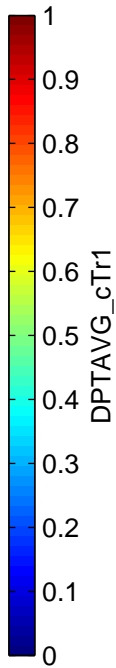
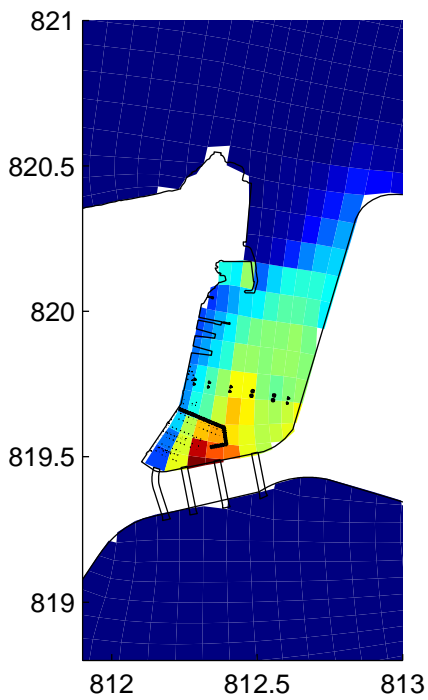
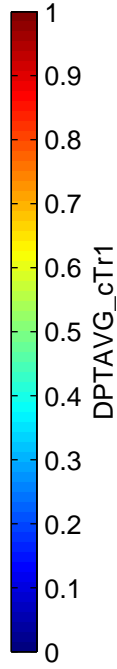
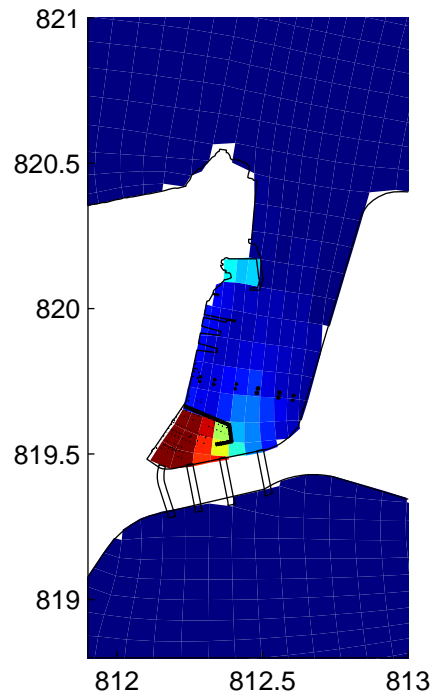
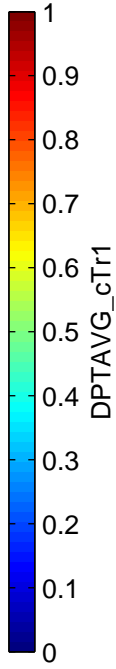
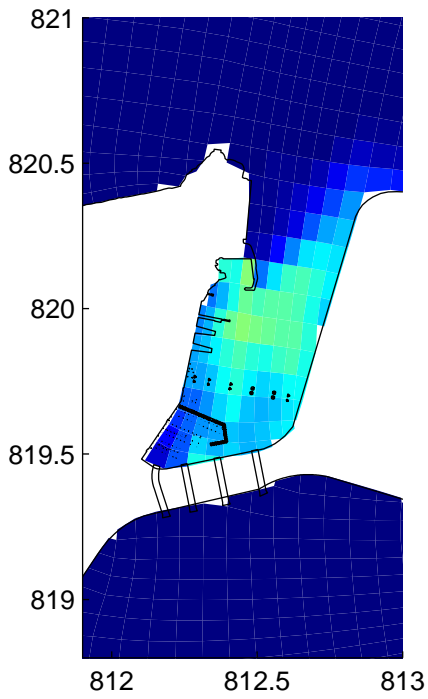

Tracer Concentration During Spring Flood Tide in Dry season at 16hr & 24 hr
 Top: Baseline; Bottom: Project; Left: 16hr; Right: 24hr

0622478

ERM

WQ/Tracer

Tracer₂.fig

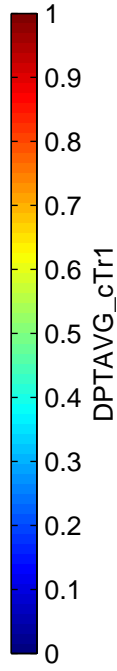
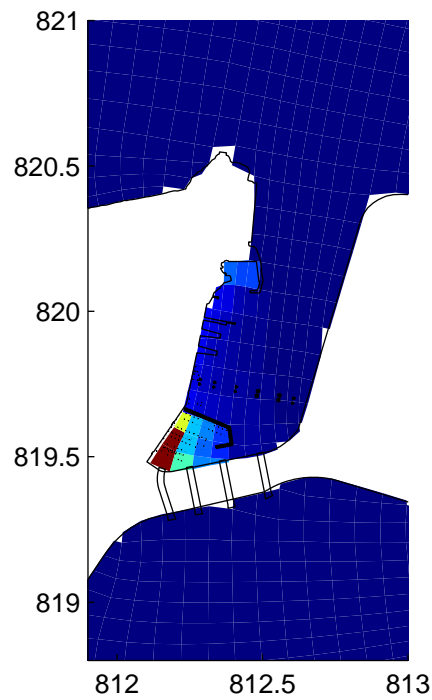
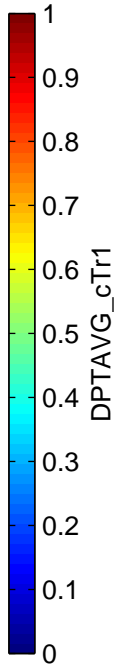
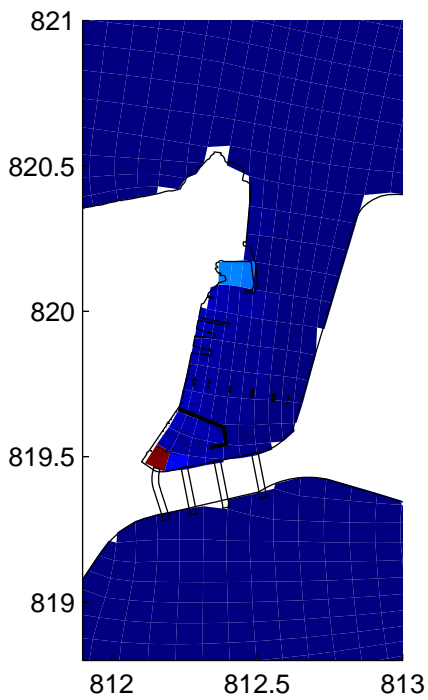
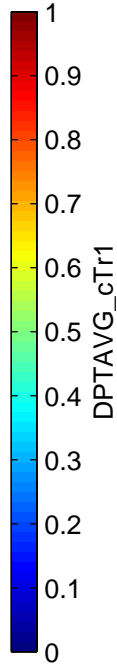
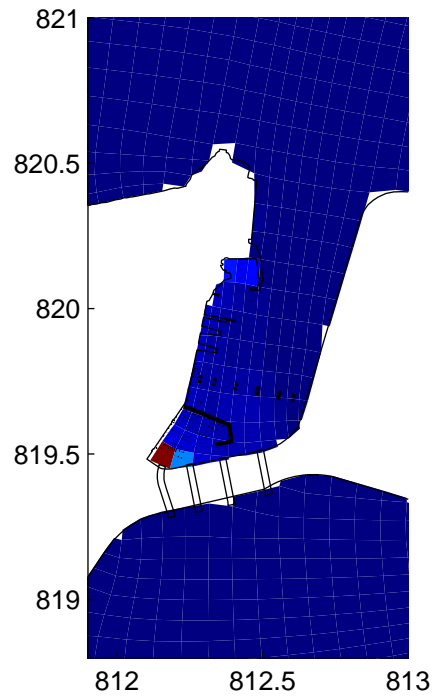
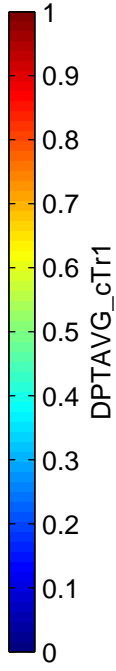
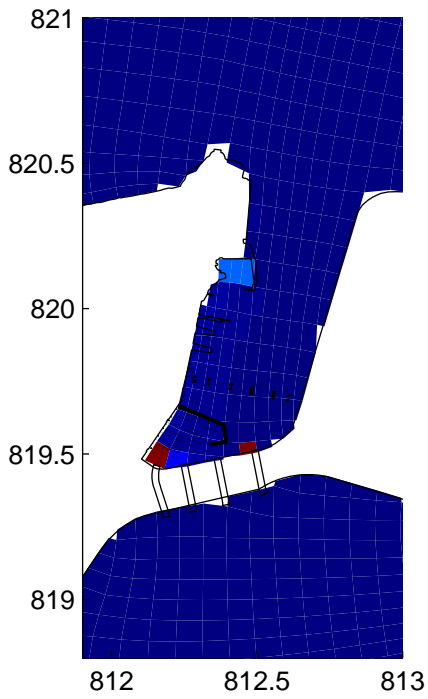

Tracer Concentration During Spring Flood Tide in Dry season at 36hr & 48 hr
 Top: Baseline; Bottom: Project; Left: 36hr; Right: 48hr

0622478

ERM

WQ/Tracer

Tracer₂.fig

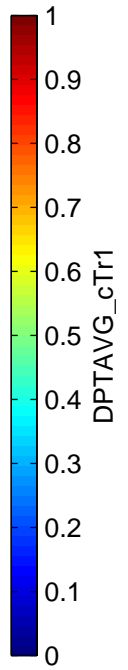
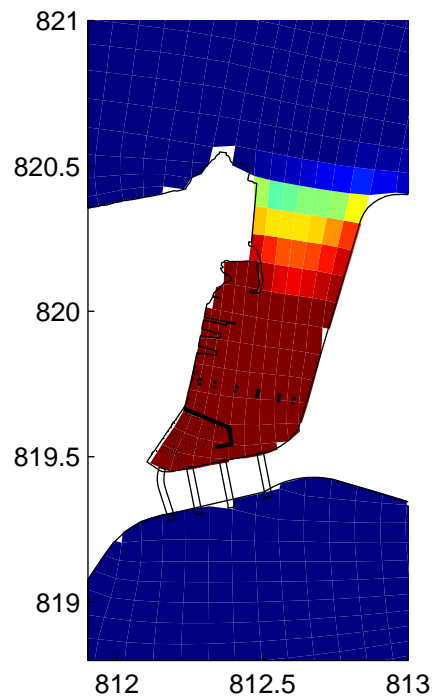
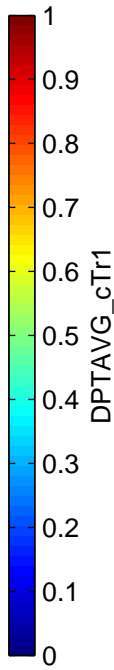
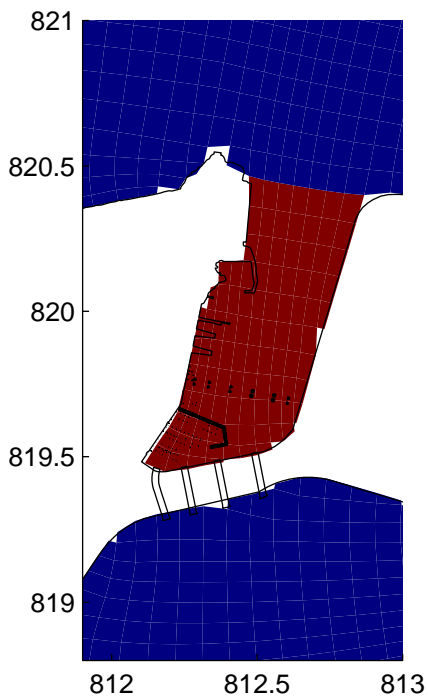
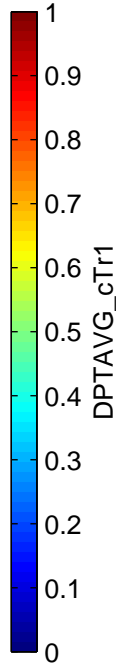
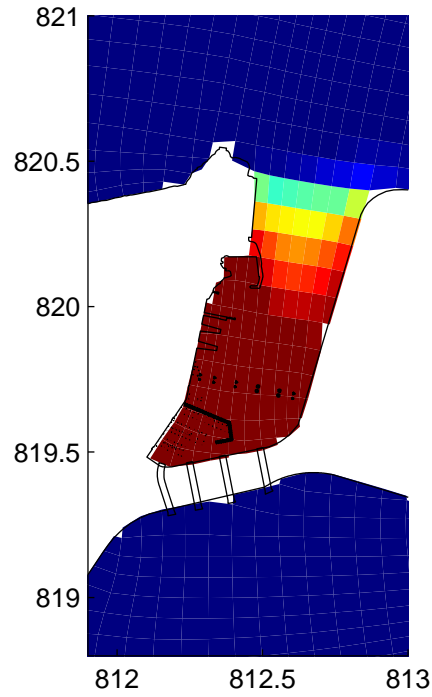
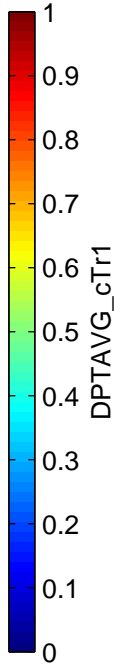
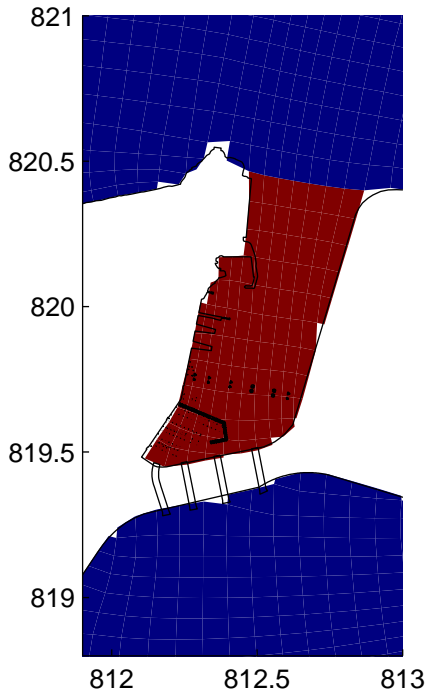

Tracer Concentration During Spring High Water in Dry season at 0hr & 1 hr
 Top: Baseline; Bottom: Project; Left: 0hr; Right: 1hr

0622478

ERM

WQ/Tracer

Tracer₂.fig

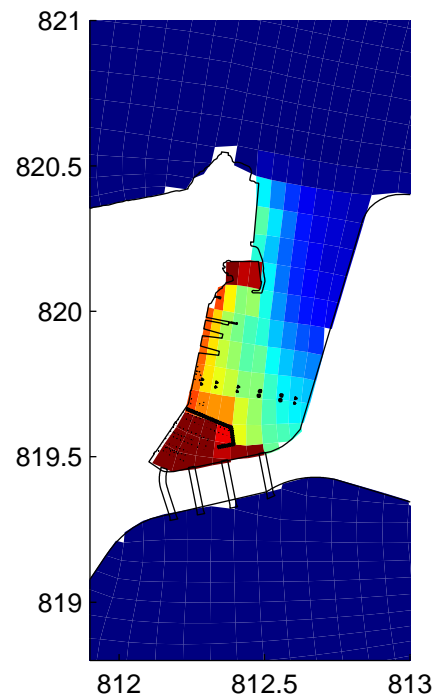
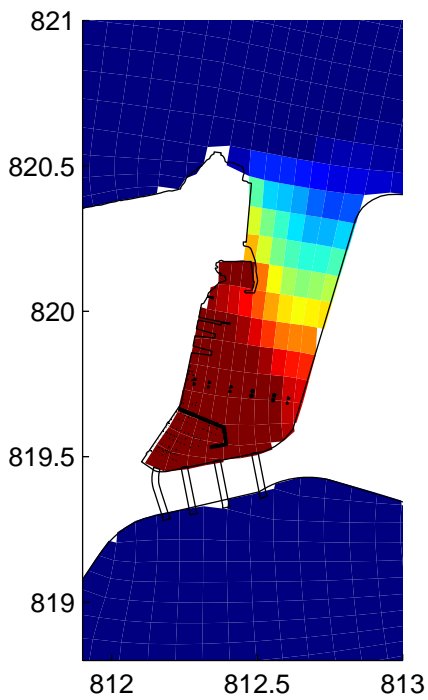
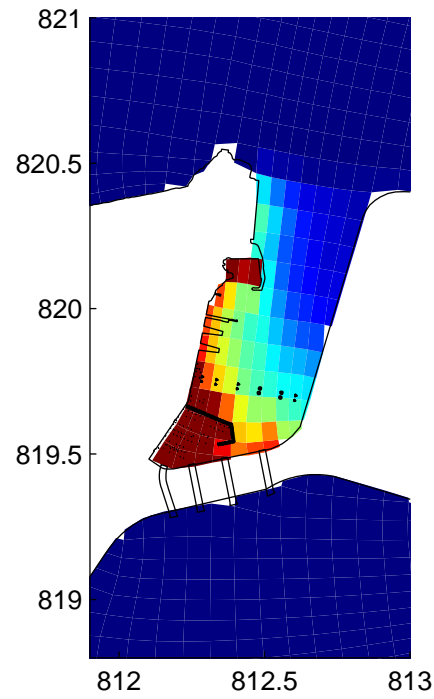
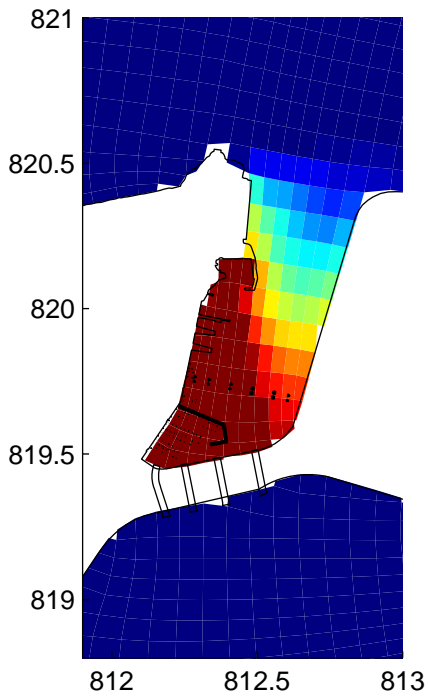

Tracer Concentration During Spring High Water in Dry season at 2hr & 4 hr
 Top: Baseline; Bottom: Project; Left: 2hr; Right: 4hr

0622478

ERM

WQ/Tracer

Tracer₂.fig

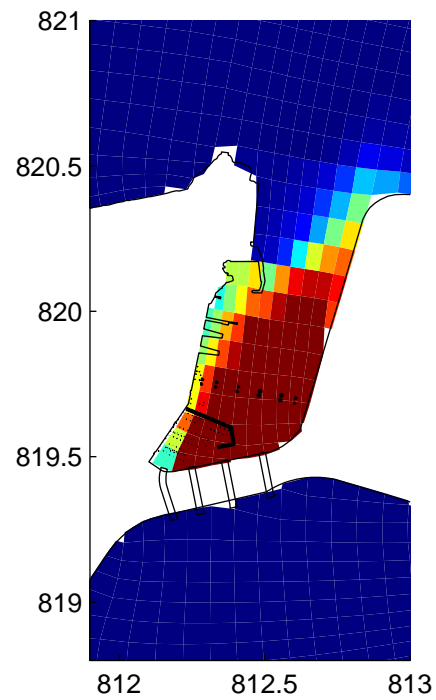
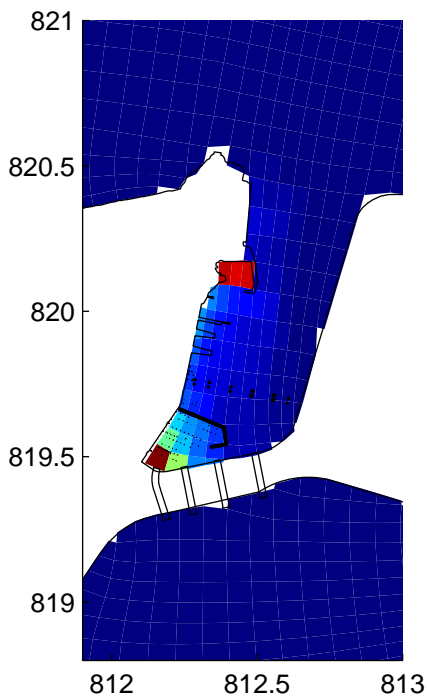
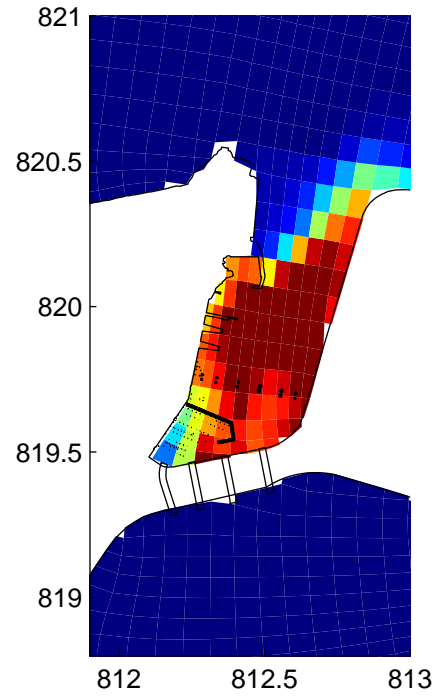
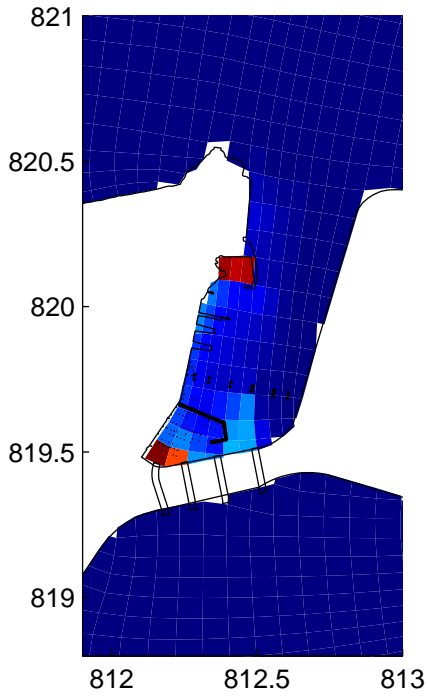

Tracer Concentration During Spring High Water in Dry season at 8hr & 12 hr
 Top: Baseline; Bottom: Project; Left: 8hr; Right: 12hr

0622478

ERM

WQ/Tracer

Tracer₂.fig

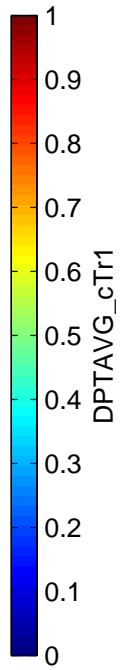
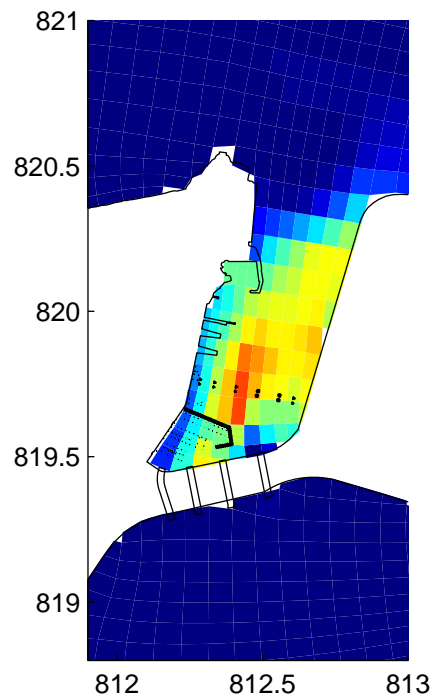
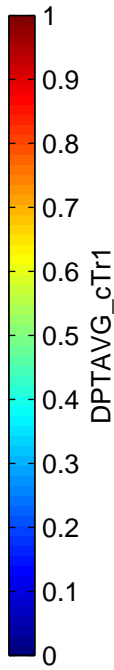
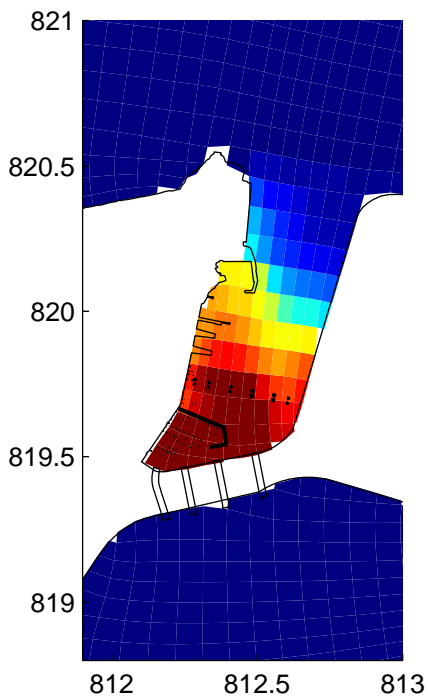
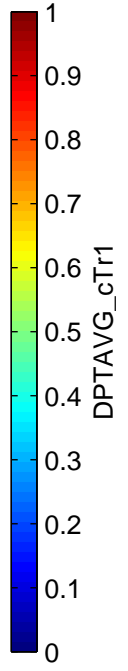
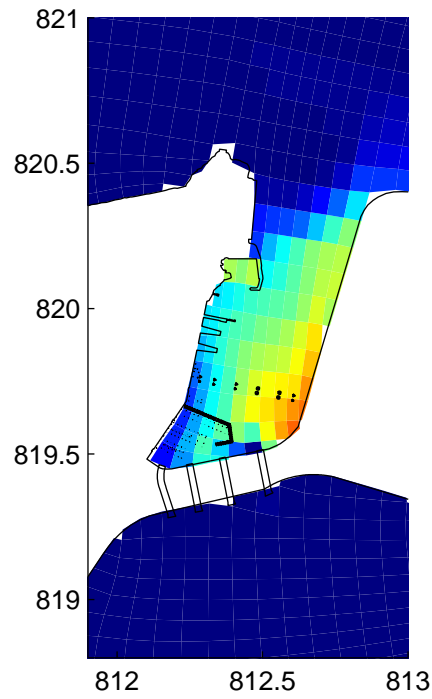
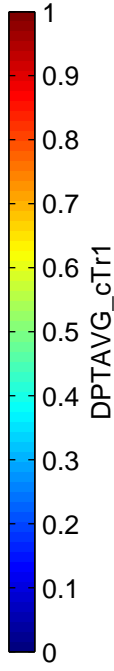
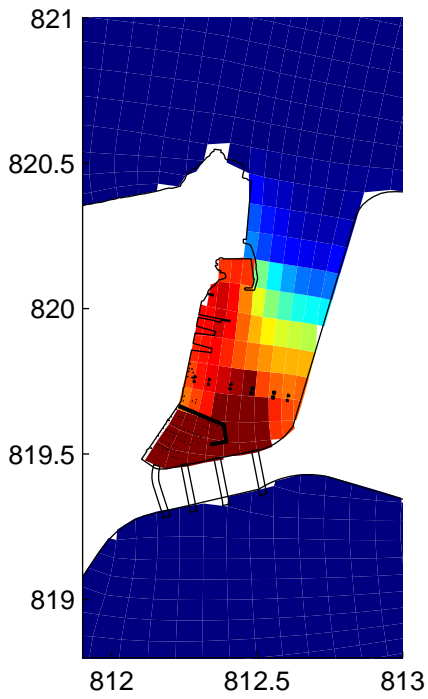

Tracer Concentration During Spring High Water in Dry season at 16hr & 24 hr
 Top: Baseline; Bottom: Project; Left: 16hr; Right: 24hr

0622478

ERM

WQ/Tracer

Tracer₂.fig

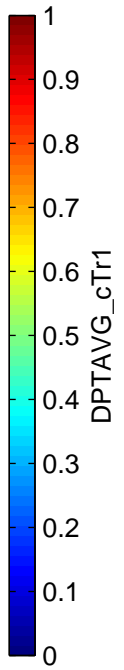
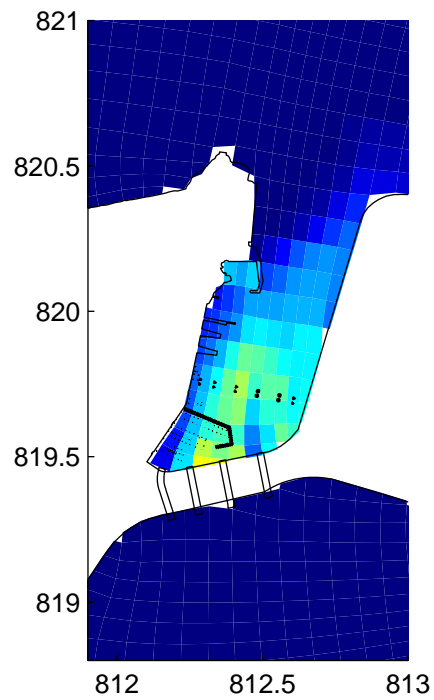
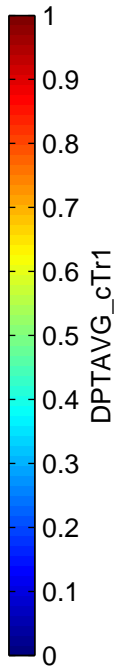
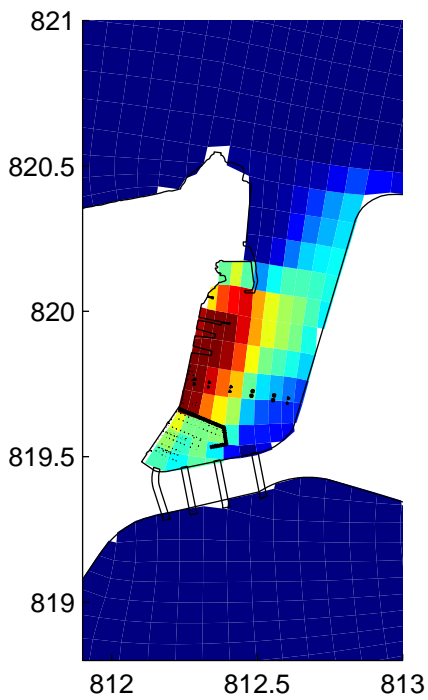
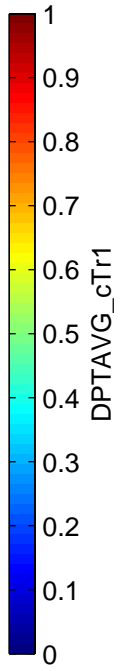
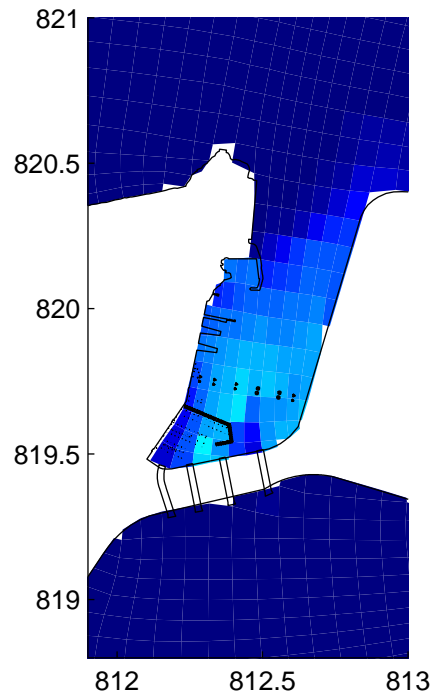
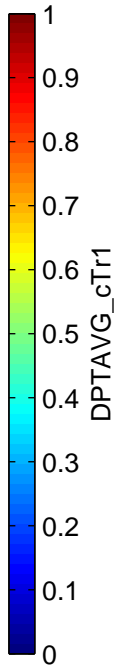
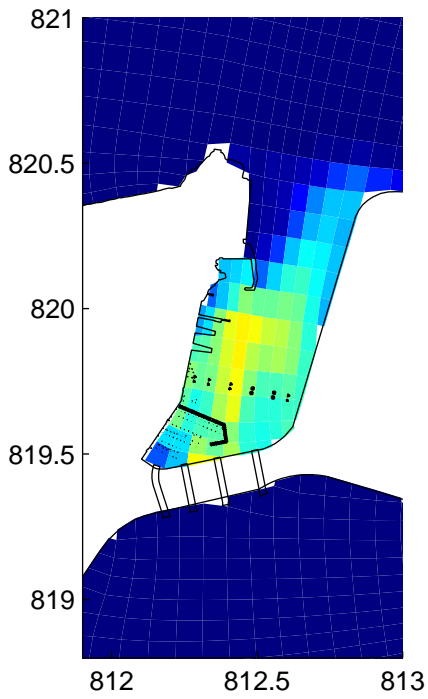

Tracer Concentration During Spring High Water in Dry season at 36hr & 48 hr
 Top: Baseline; Bottom: Project; Left: 36hr; Right: 48hr

0622478

ERM

WQ/Tracer

Tracer₂.fig

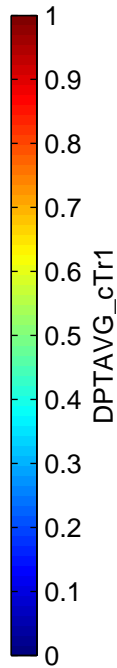
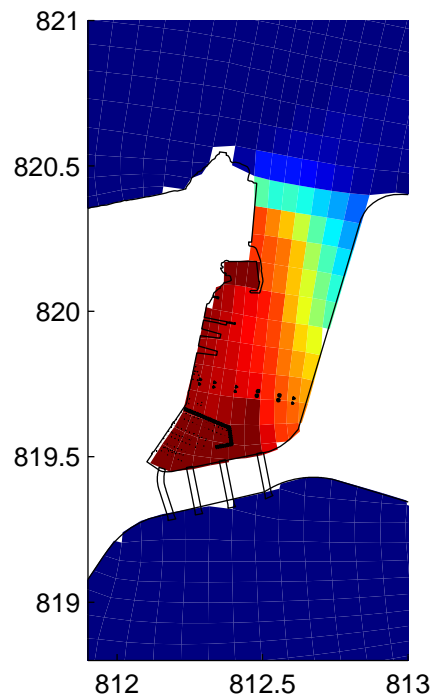
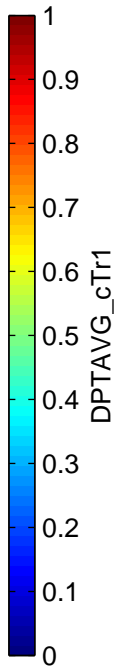
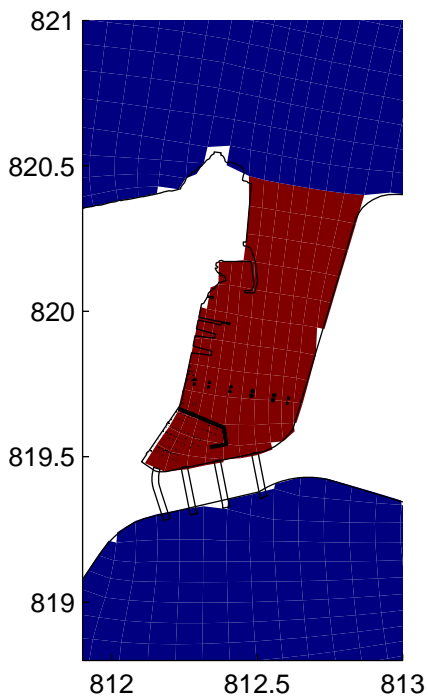
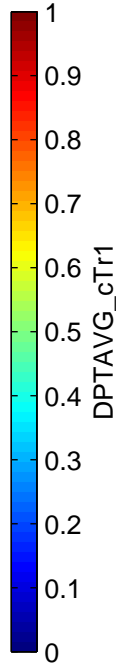
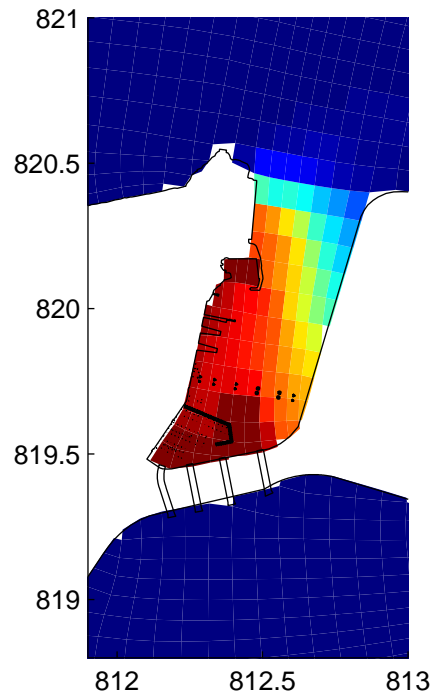
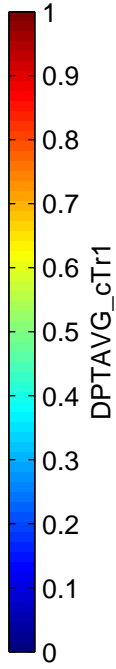
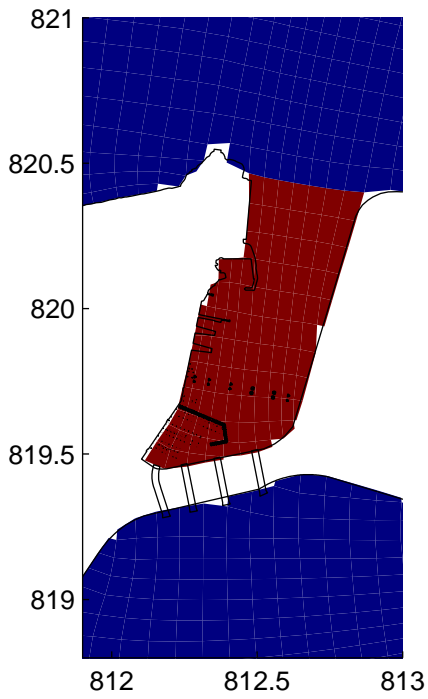

Tracer Concentration During Spring Low Water in Dry season at 0hr & 1 hr
 Top: Baseline; Bottom: Project; Left: 0hr; Right: 1hr

0622478

ERM

WQ/Tracer

Tracer₂.fig

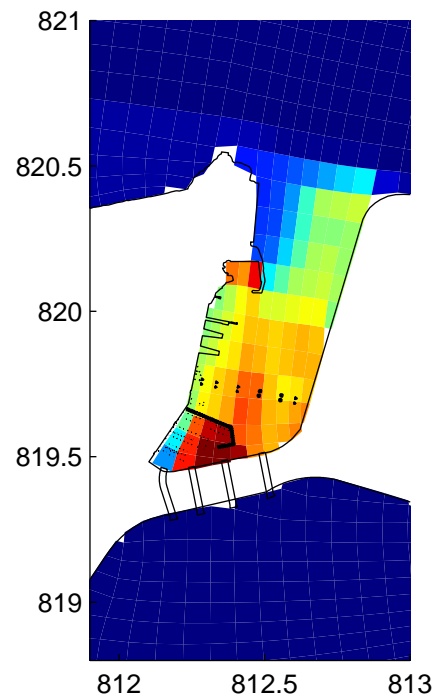
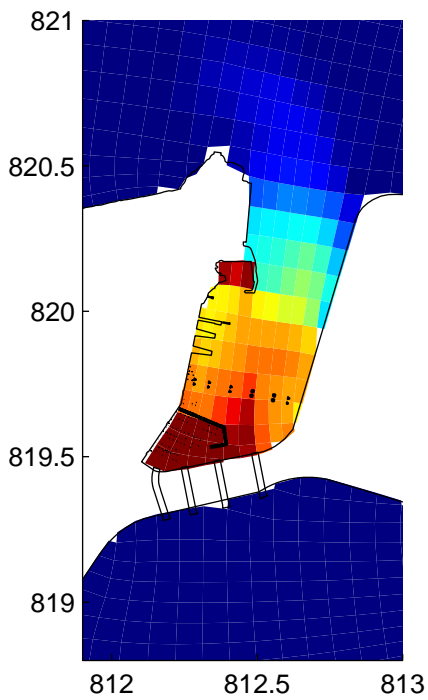
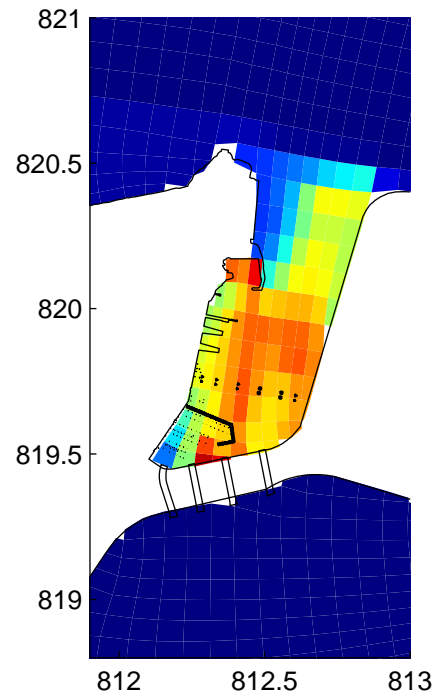
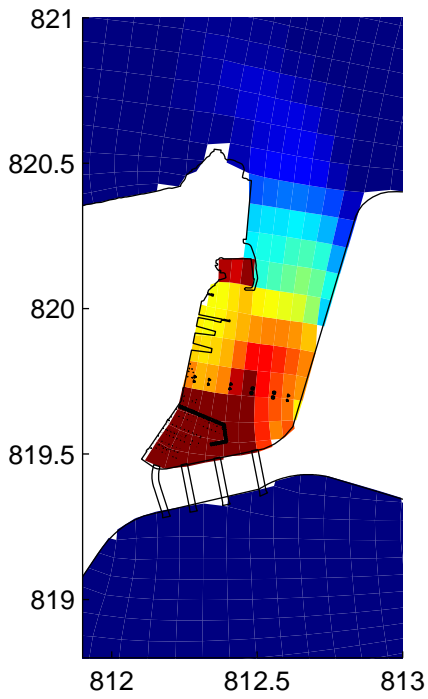

Tracer Concentration During Spring Low Water in Dry season at 2hr & 4 hr
 Top: Baseline; Bottom: Project; Left: 2hr; Right: 4hr

0622478

ERM

WQ/Tracer

Tracer₂.fig

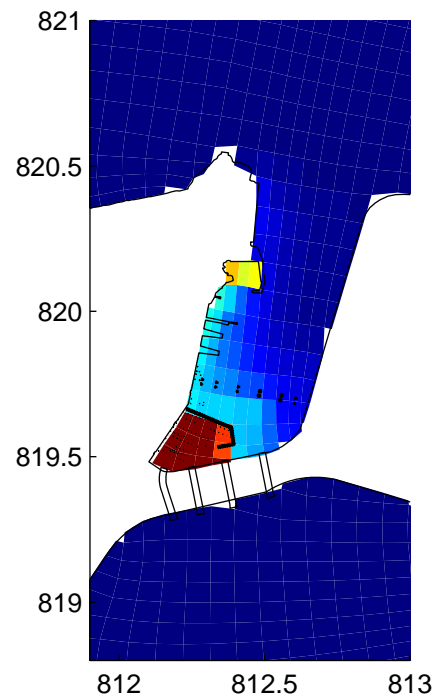
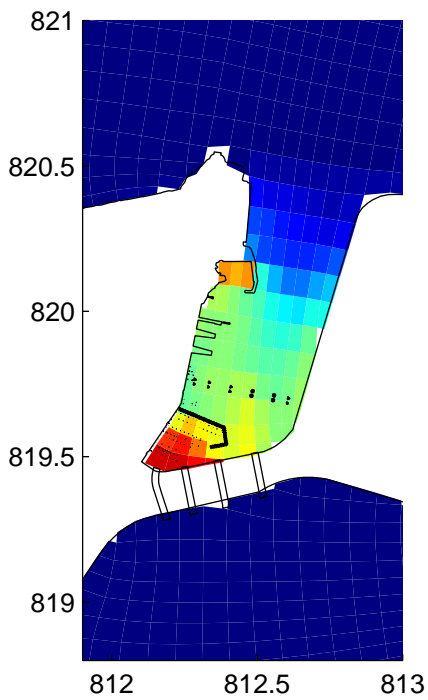
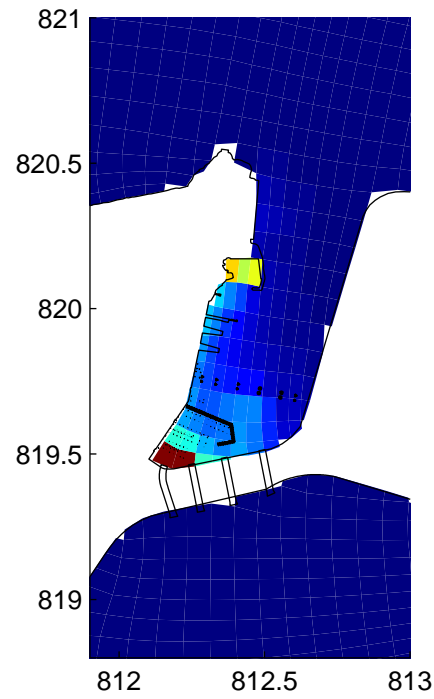
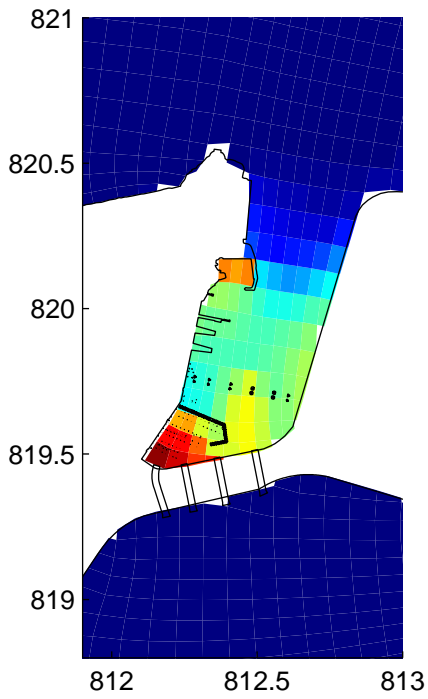

Tracer Concentration During Spring Low Water in Dry season at 8hr & 12 hr
 Top: Baseline; Bottom: Project; Left: 8hr; Right: 12hr

0622478

ERM

WQ/Tracer

Tracer₂.fig

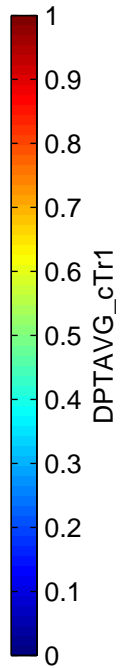
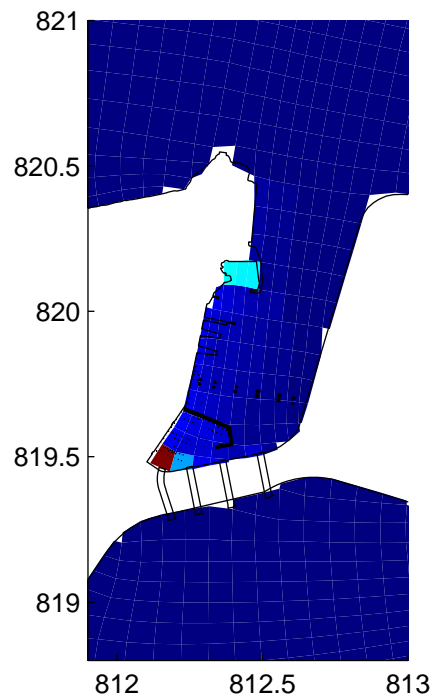
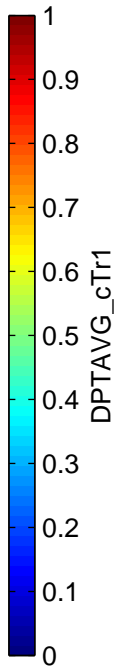
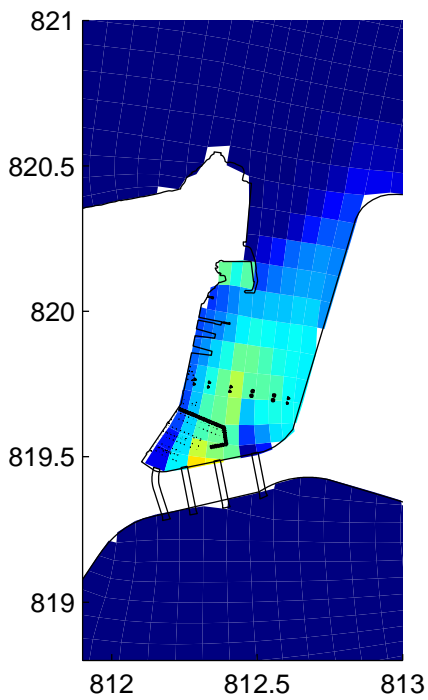
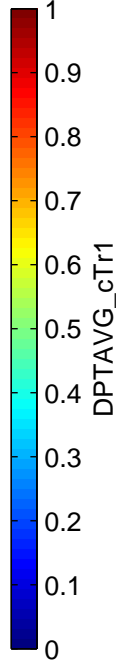
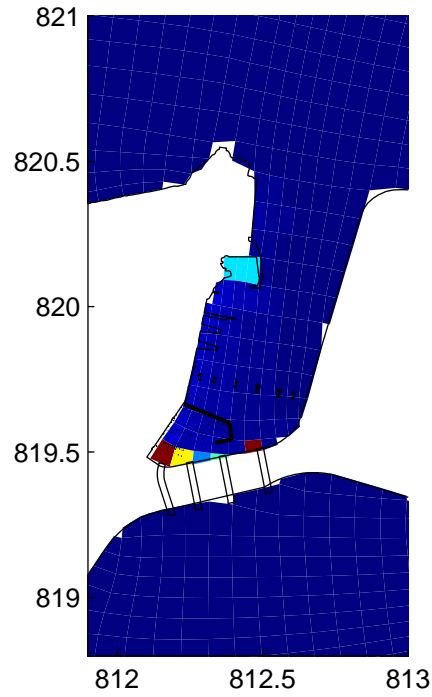
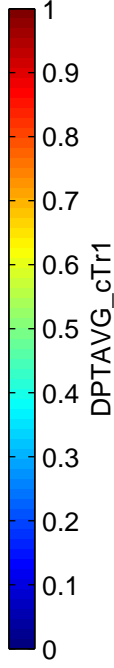
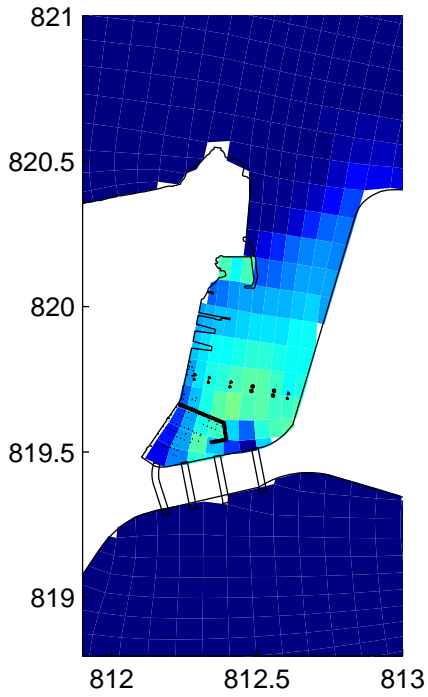

Tracer Concentration During Spring Low Water in Dry season at 16hr & 24 hr
 Top: Baseline; Bottom: Project; Left: 16hr; Right: 24hr

0622478

ERM

WQ/Tracer

Tracer₂.fig

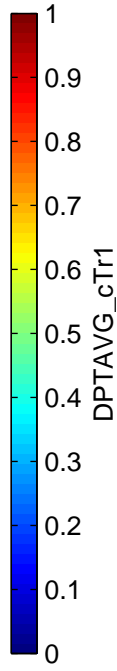
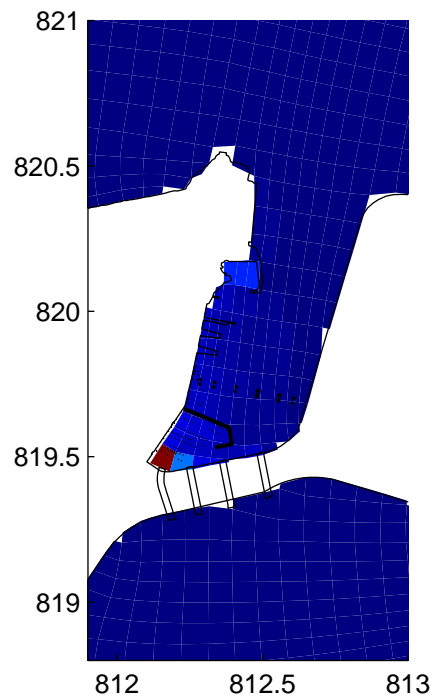
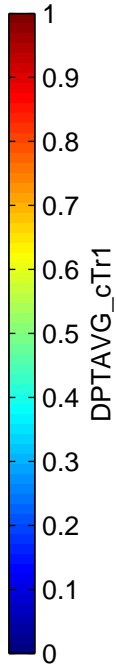
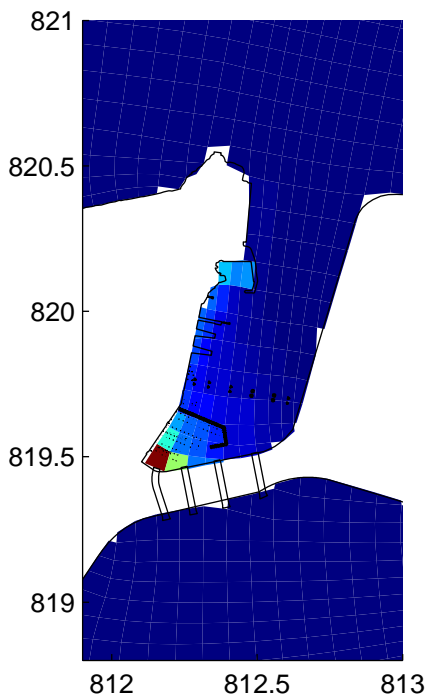
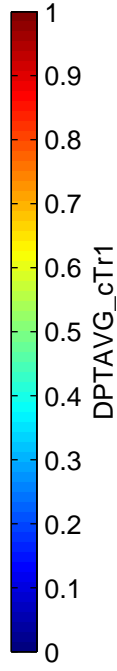
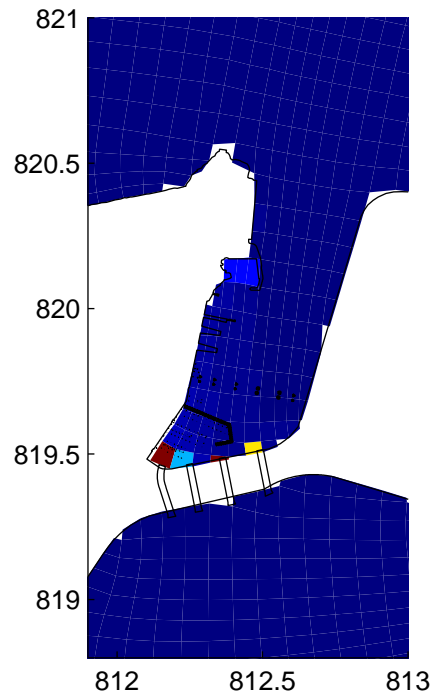
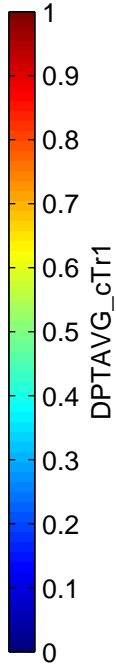
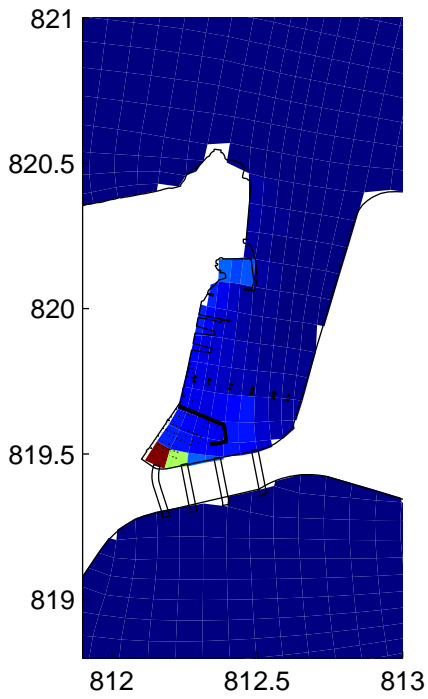

Tracer Concentration During Spring Low Water in Dry season at 36hr & 48 hr
 Top: Baseline; Bottom: Project; Left: 36hr; Right: 48hr

0622478

ERM

WQ/Tracer

Tracer₂.fig

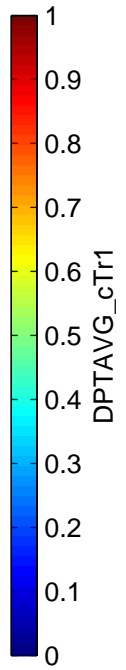
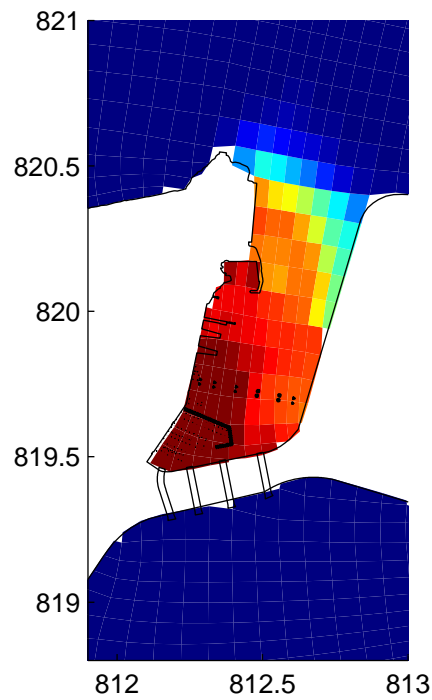
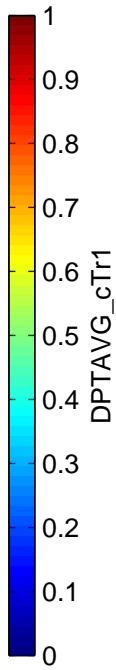
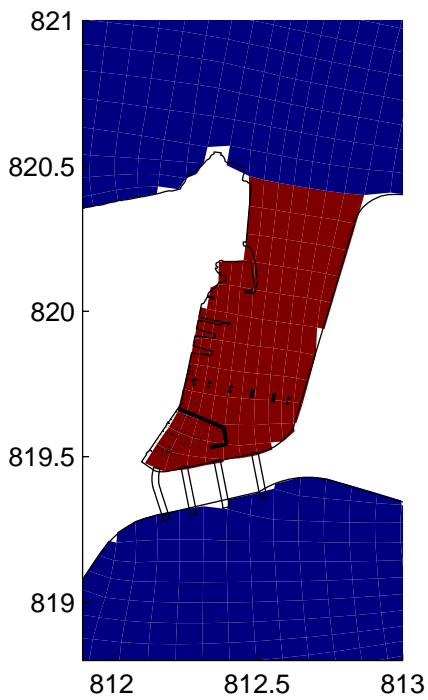
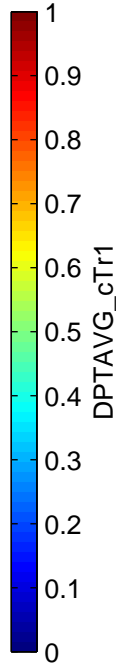
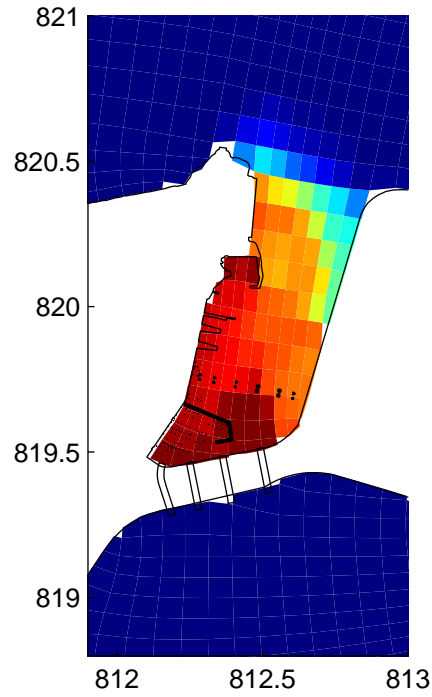
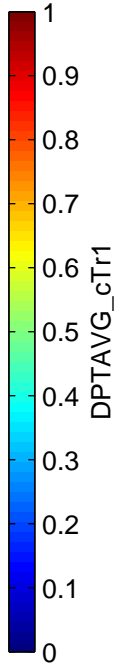
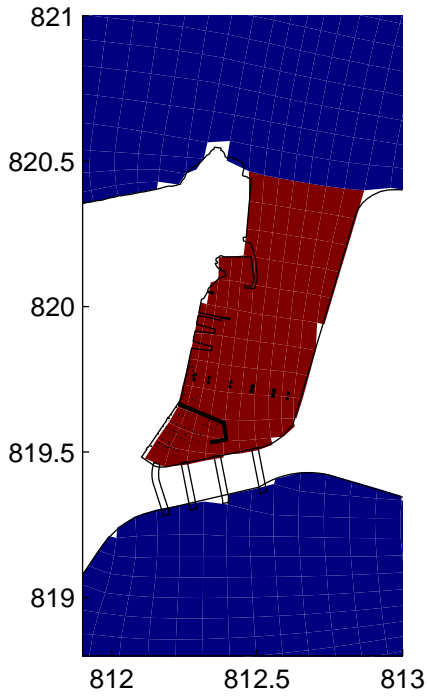

Tracer Concentration During Neap Ebb Tide in Wet season at 0hr & 1 hr
 Top: Baseline; Bottom: Project; Left: 0hr; Right: 1hr

0622478

ERM

WQ/Tracer

Tracer₂.fig

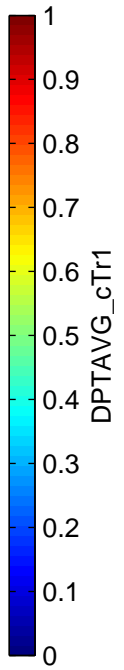
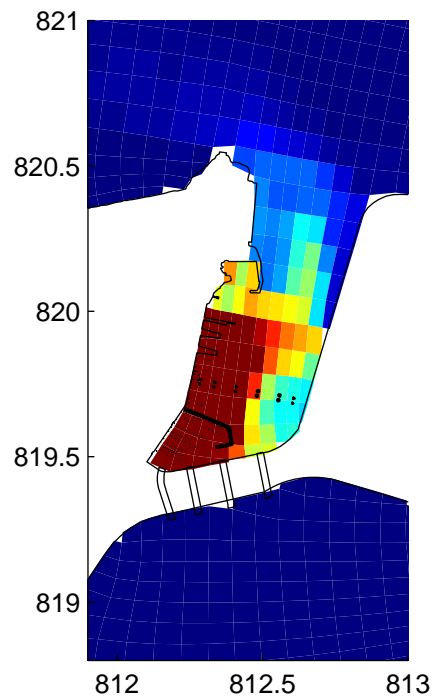
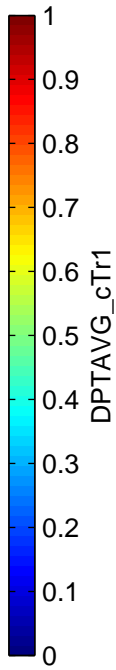
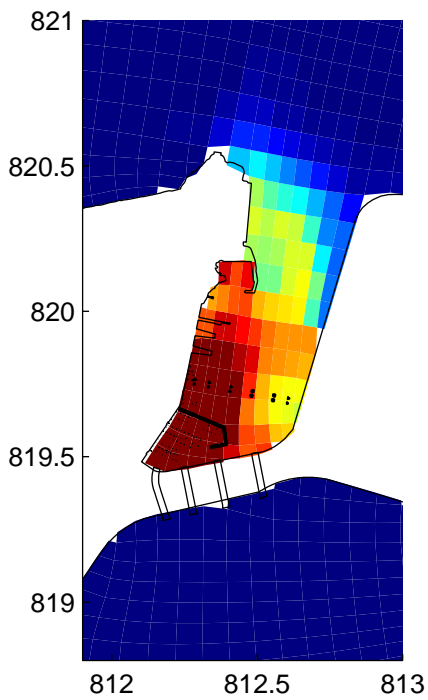
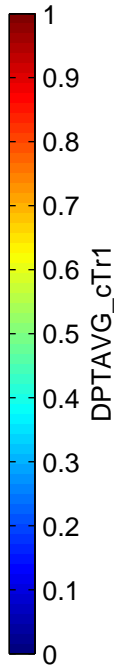
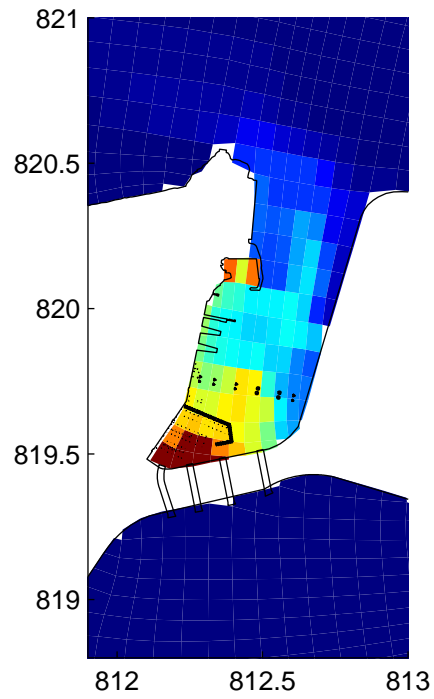
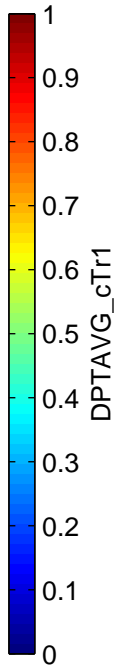
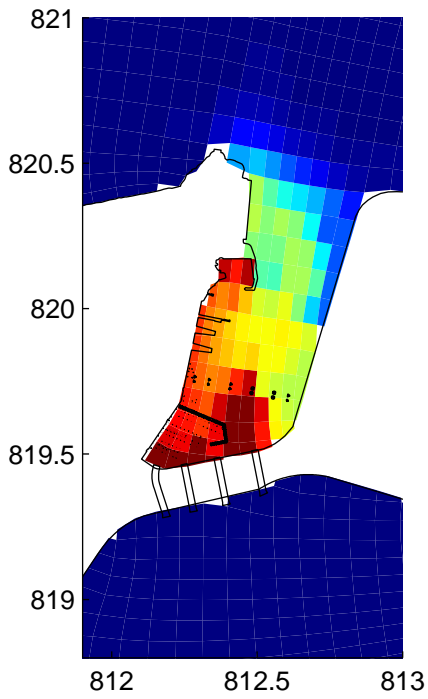

Tracer Concentration During Neap Ebb Tide in Wet season at 2hr & 4 hr
 Top: Baseline; Bottom: Project; Left: 2hr; Right: 4hr

0622478

ERM

WQ/Tracer

Tracer₂.fig

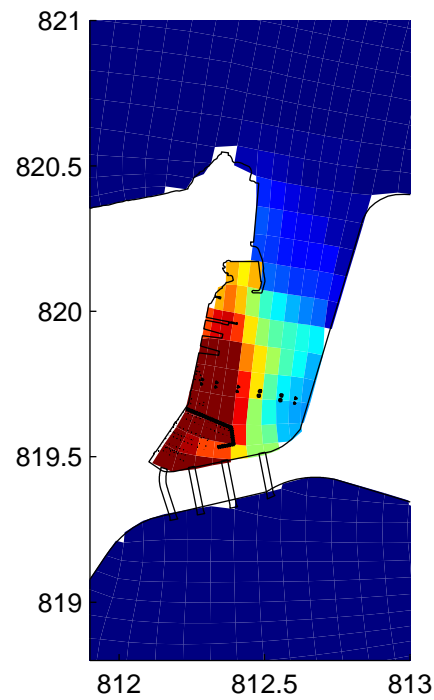
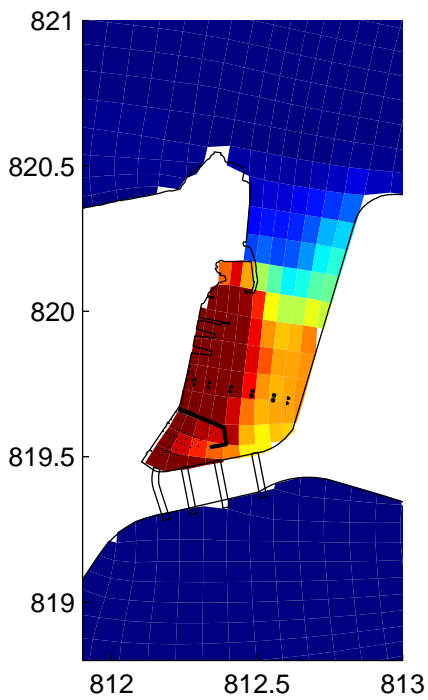
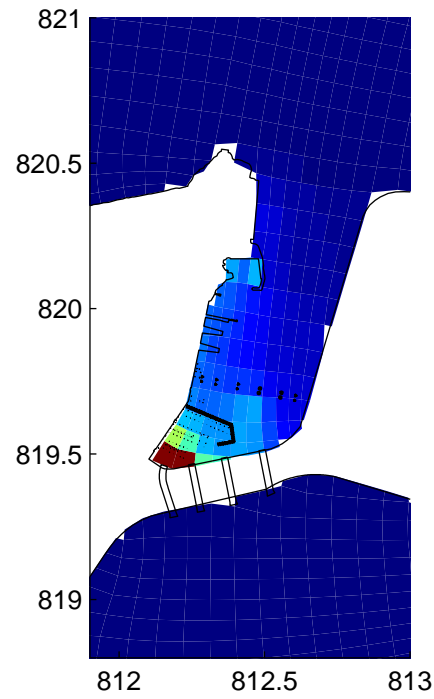
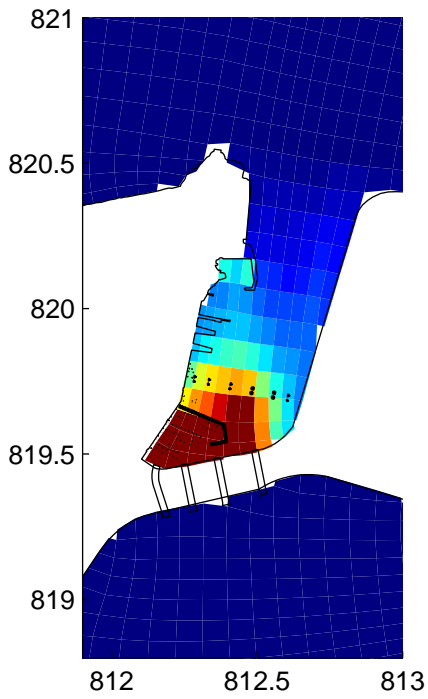

Tracer Concentration During Neap Ebb Tide in Wet season at 8hr & 12 hr
 Top: Baseline; Bottom: Project; Left: 8hr; Right: 12hr

0622478

ERM

WQ/Tracer

Tracer₂.fig

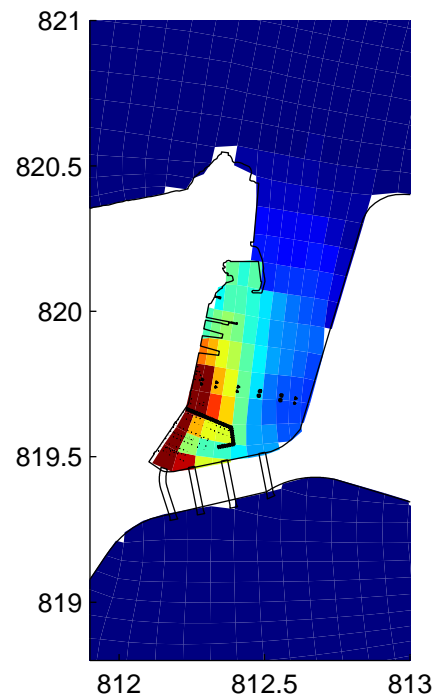
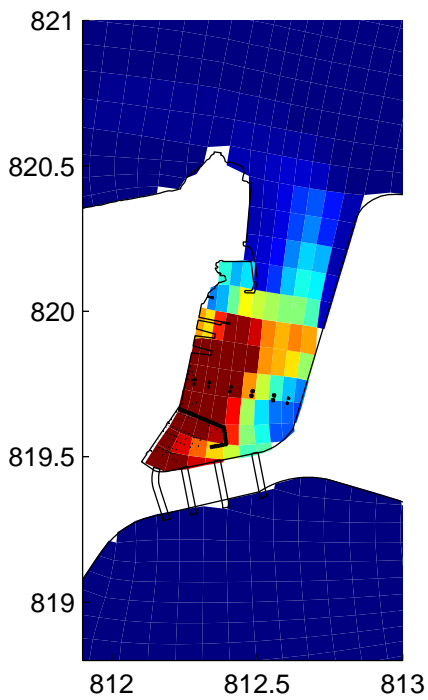
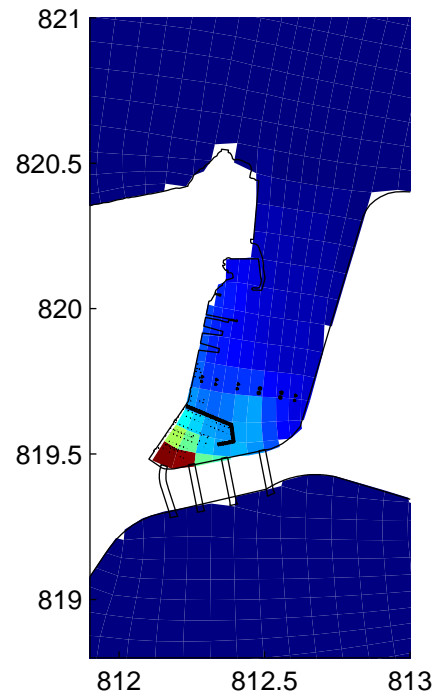
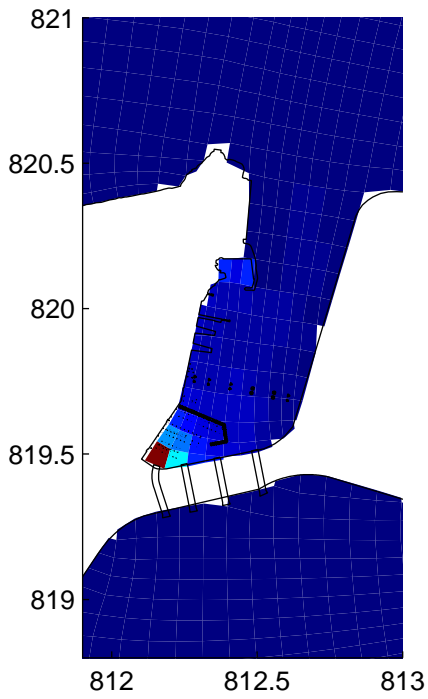

Tracer Concentration During Neap Ebb Tide in Wet season at 16hr & 24 hr
 Top: Baseline; Bottom: Project; Left: 16hr; Right: 24hr

0622478

ERM

WQ/Tracer

Tracer₂.fig

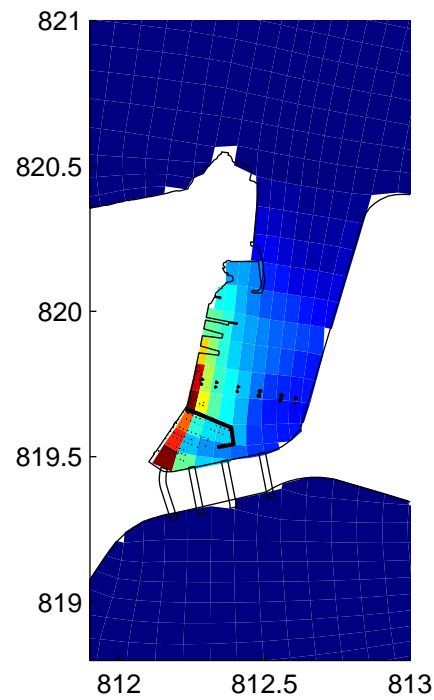
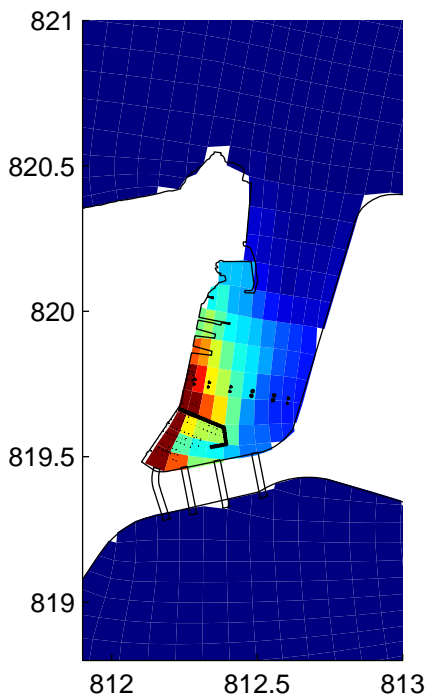
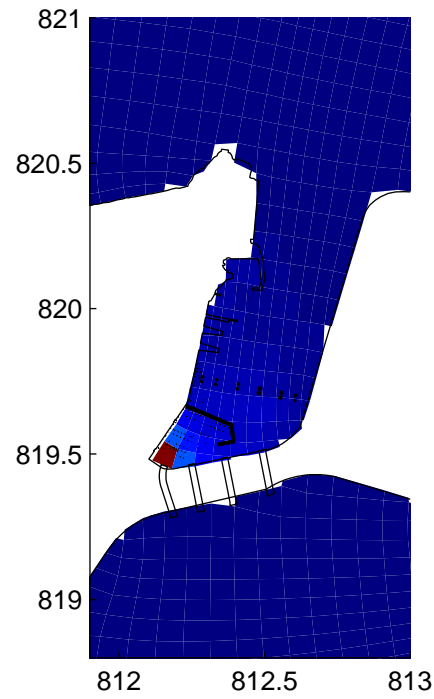
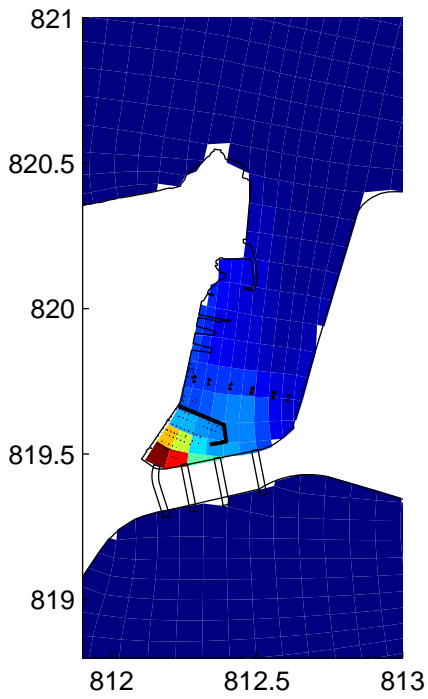

Tracer Concentration During Neap Ebb Tide in Wet season at 36hr & 48 hr
 Top: Baseline; Bottom: Project; Left: 36hr; Right: 48hr

0622478

ERM

WQ/Tracer

Tracer₂.fig

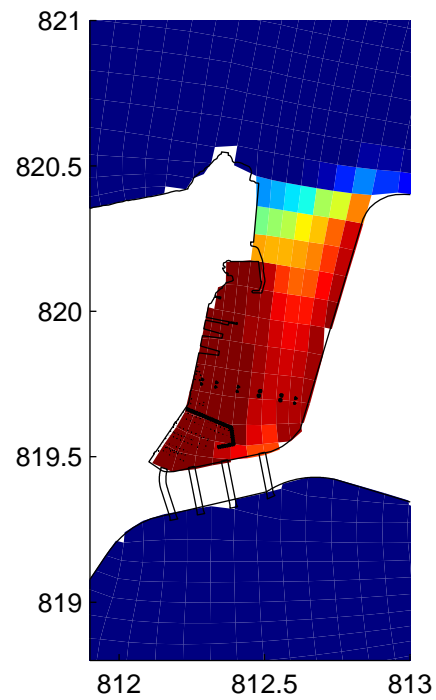
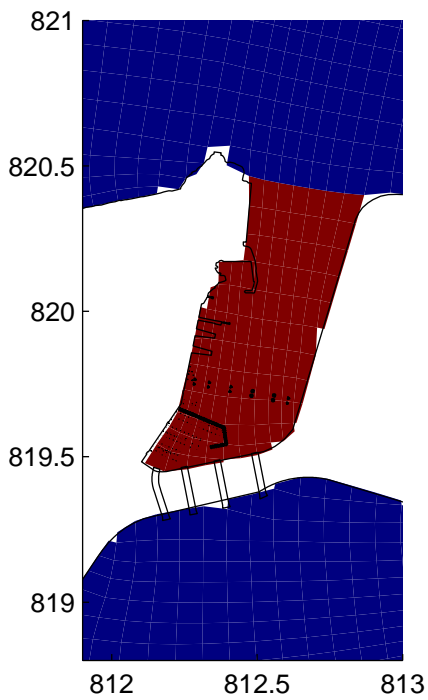
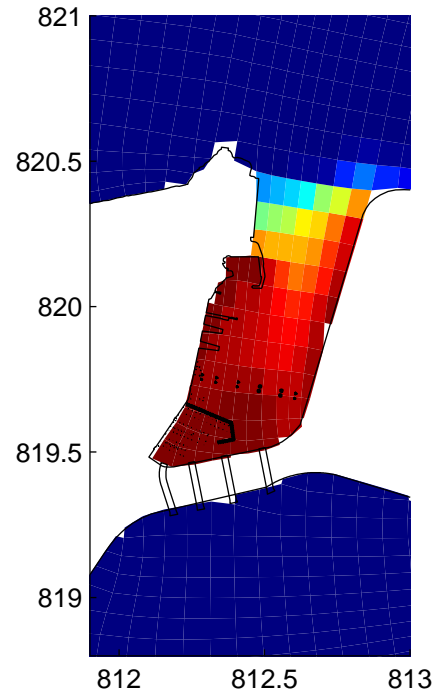
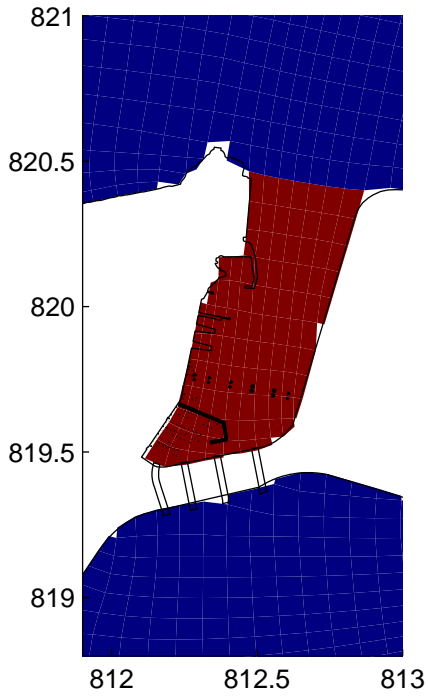

Tracer Concentration During Neap Flood Tide in Wet season at 0hr & 1 hr
 Top: Baseline; Bottom: Project; Left: 0hr; Right: 1hr

0622478

ERM

WQ/Tracer

Tracer₂.fig

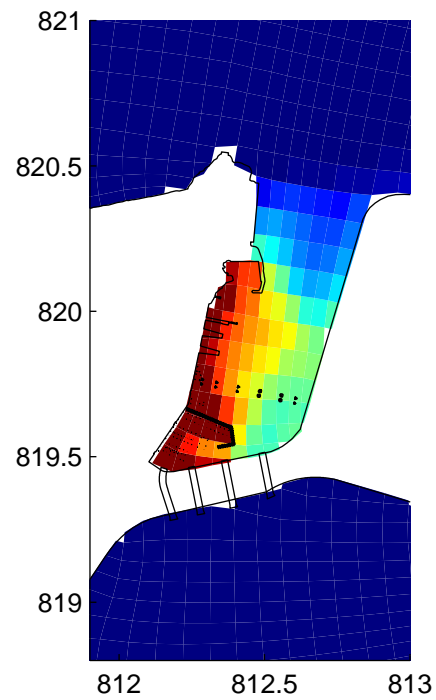
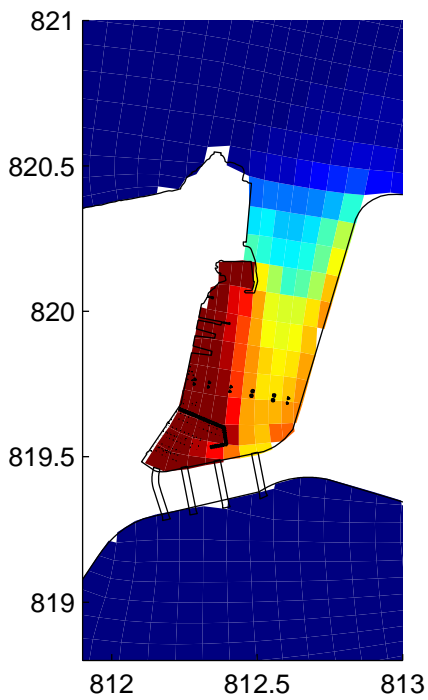
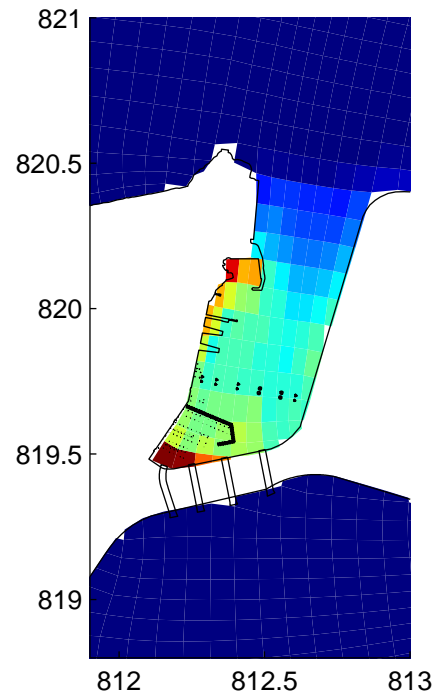
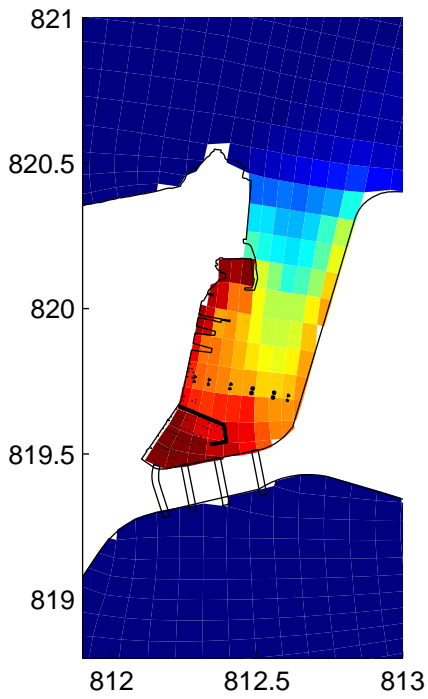

Tracer Concentration During Neap Flood Tide in Wet season at 2hr & 4 hr
 Top: Baseline; Bottom: Project; Left: 2hr; Right: 4hr

0622478

ERM

WQ/Tracer

Tracer₂.fig

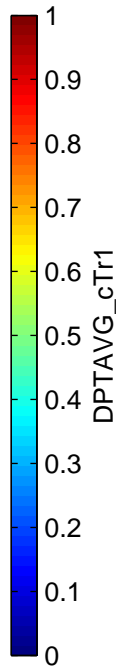
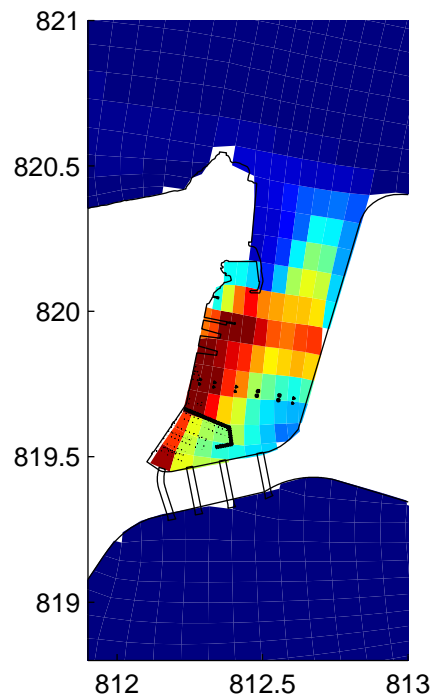
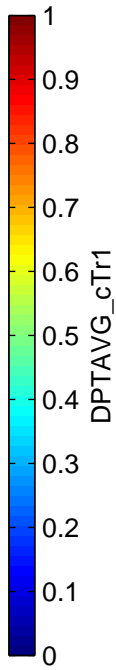
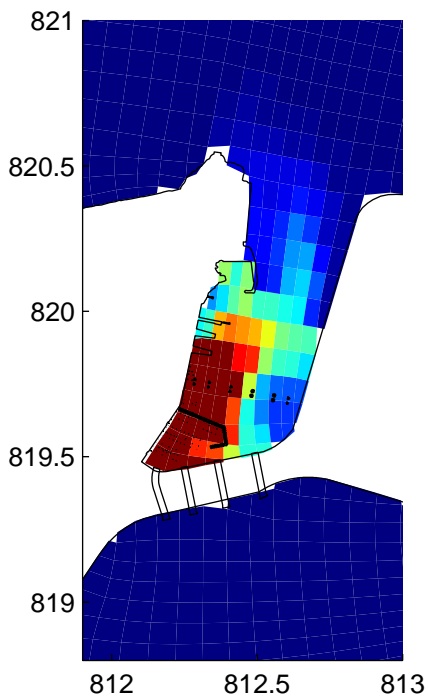
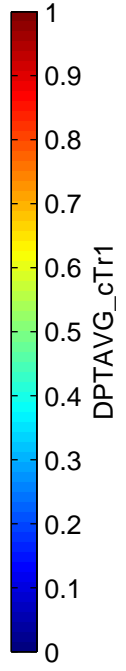
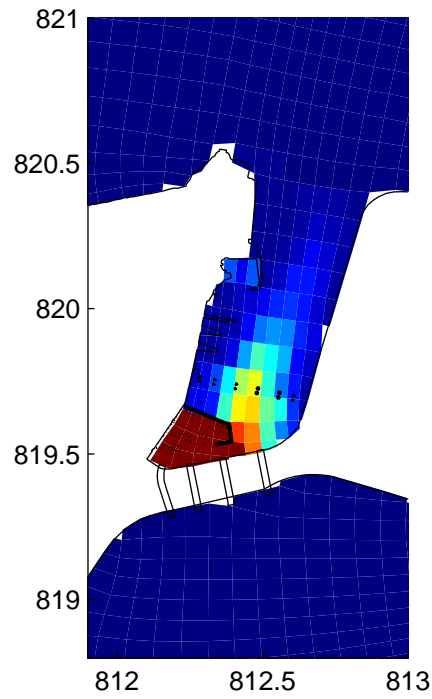
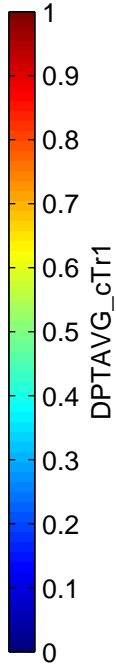
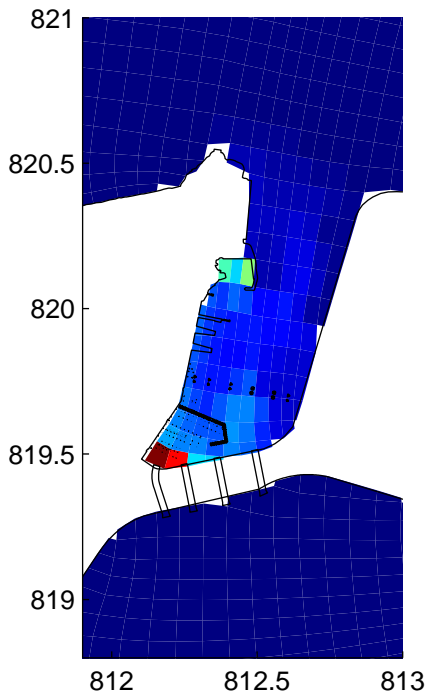

Tracer Concentration During Neap Flood Tide in Wet season at 8hr & 12 hr
 Top: Baseline; Bottom: Project; Left: 8hr; Right: 12hr

0622478

ERM

WQ/Tracer

Tracer₂.fig

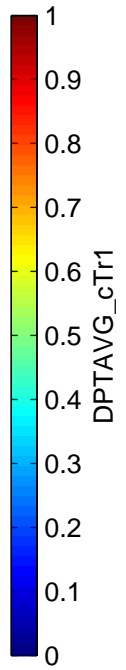
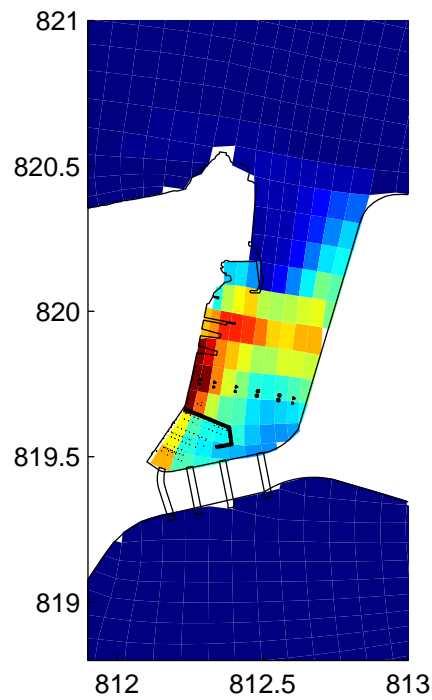
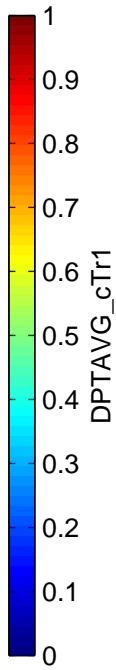
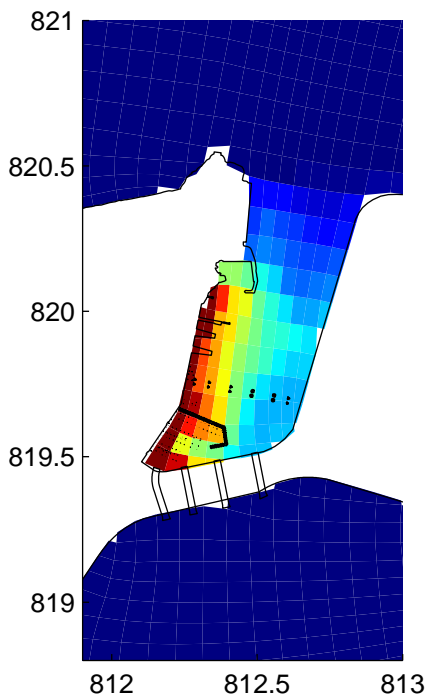
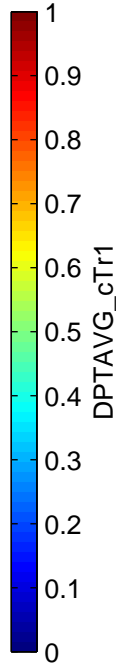
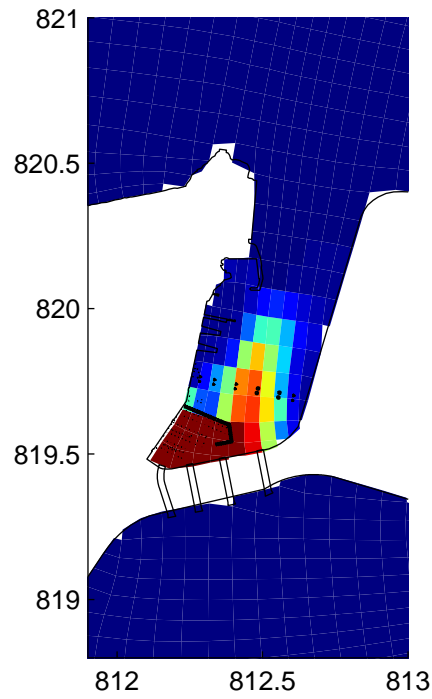
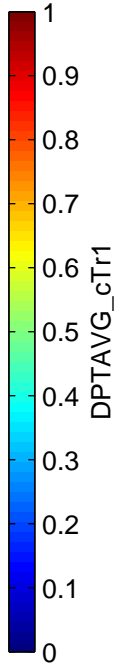
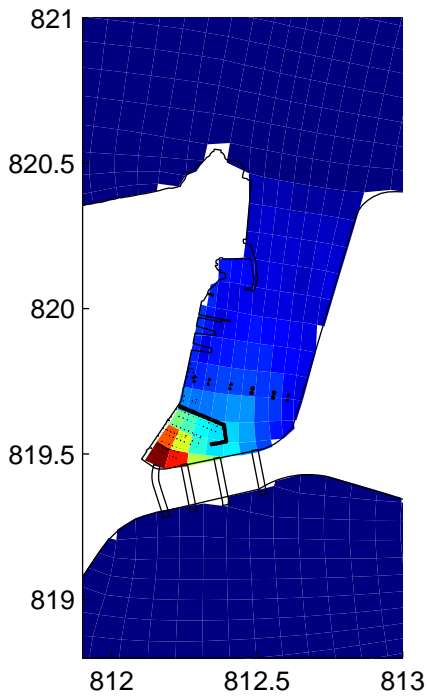

Tracer Concentration During Neap Flood Tide in Wet season at 16hr & 24 hr
 Top: Baseline; Bottom: Project; Left: 16hr; Right: 24hr

0622478

ERM

WQ/Tracer

Tracer₂.fig

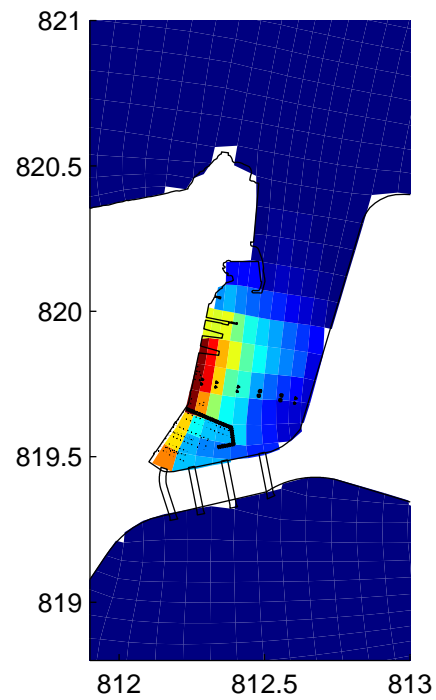
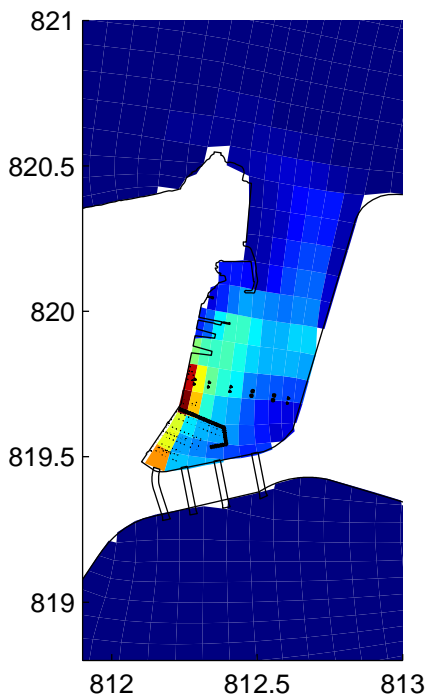
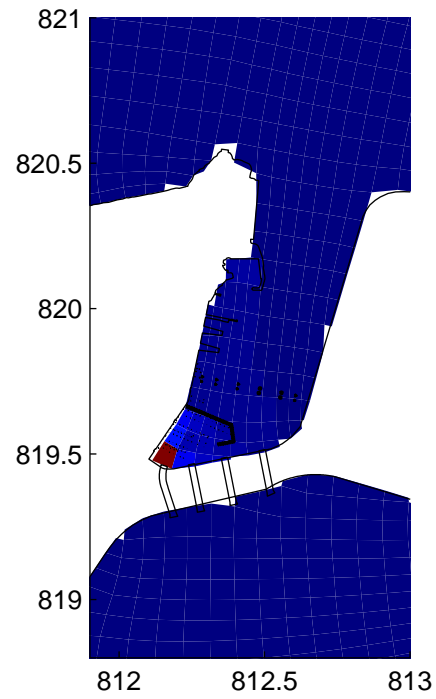
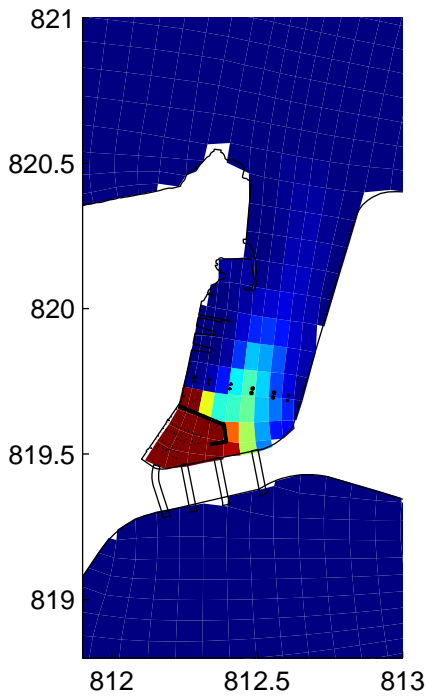

Tracer Concentration During Neap Flood Tide in Wet season at 36hr & 48 hr
 Top: Baseline; Bottom: Project; Left: 36hr; Right: 48hr

0622478

ERM

WQ/Tracer

Tracer₂.fig

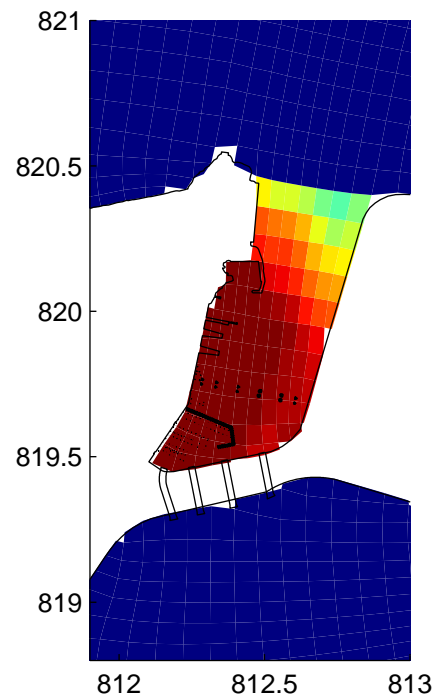
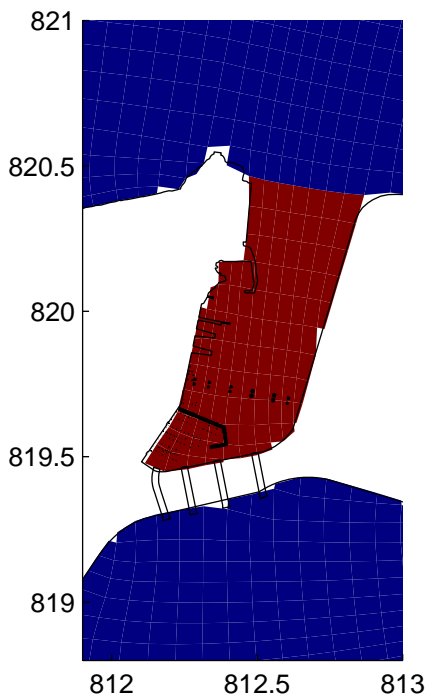
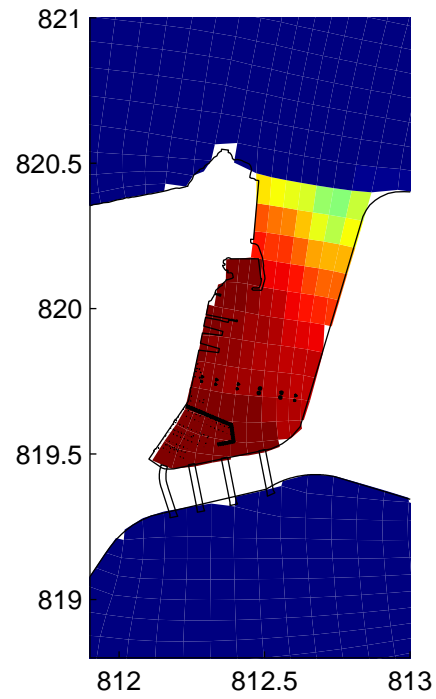
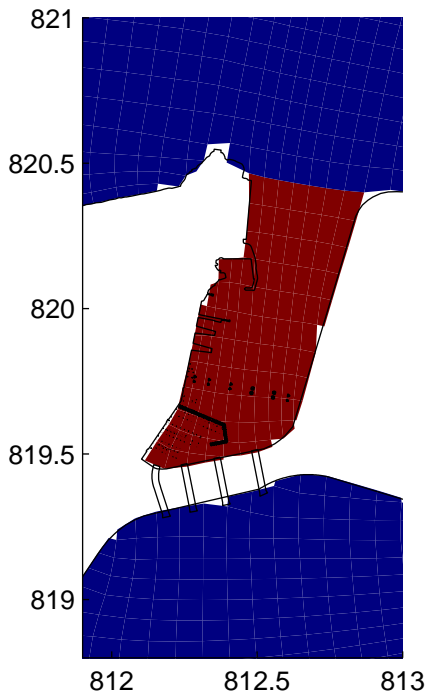

Tracer Concentration During Neap High Water in Wet season at 0hr & 1 hr
 Top: Baseline; Bottom: Project; Left: 0hr; Right: 1hr

0622478

ERM

WQ/Tracer

Tracer₂.fig

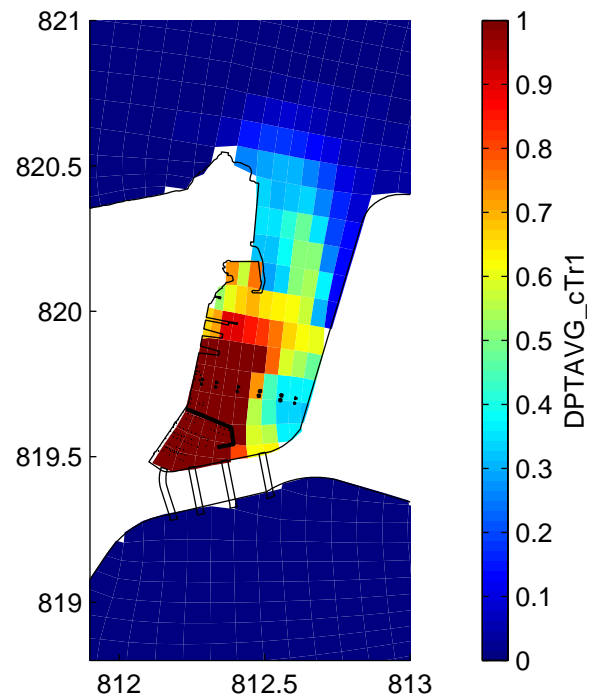
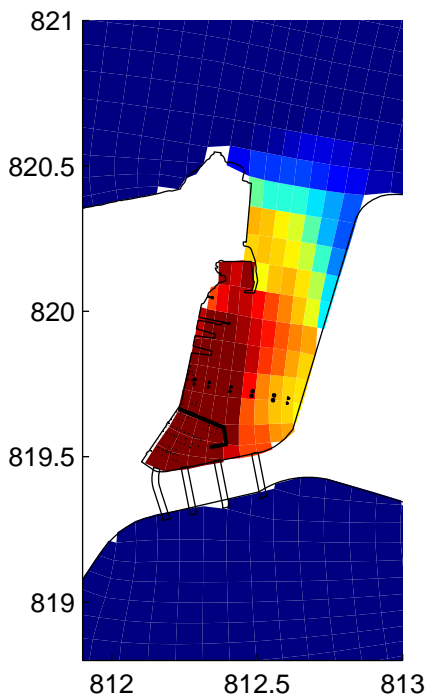
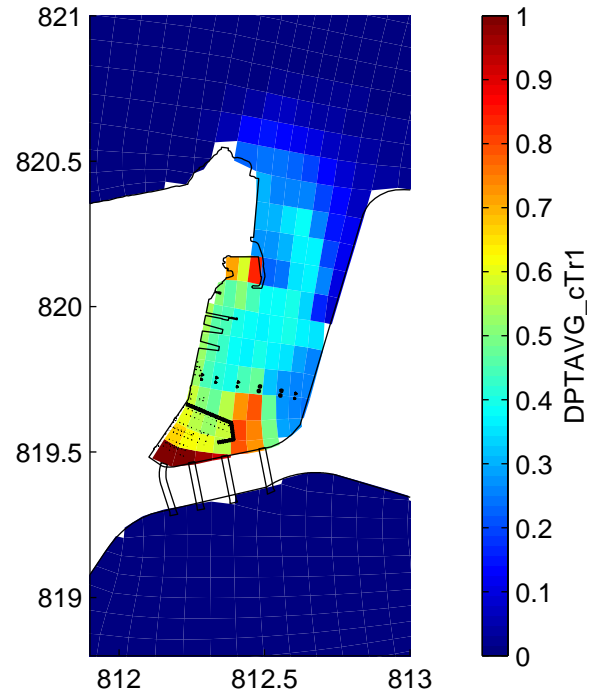
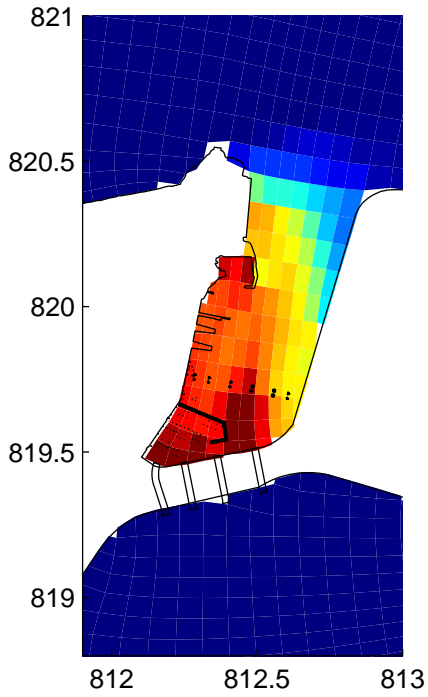

Tracer Concentration During Neap High Water in Wet season at 2hr & 4 hr
 Top: Baseline; Bottom: Project; Left: 2hr; Right: 4hr

0622478

ERM

WQ/Tracer

Tracer₂.fig

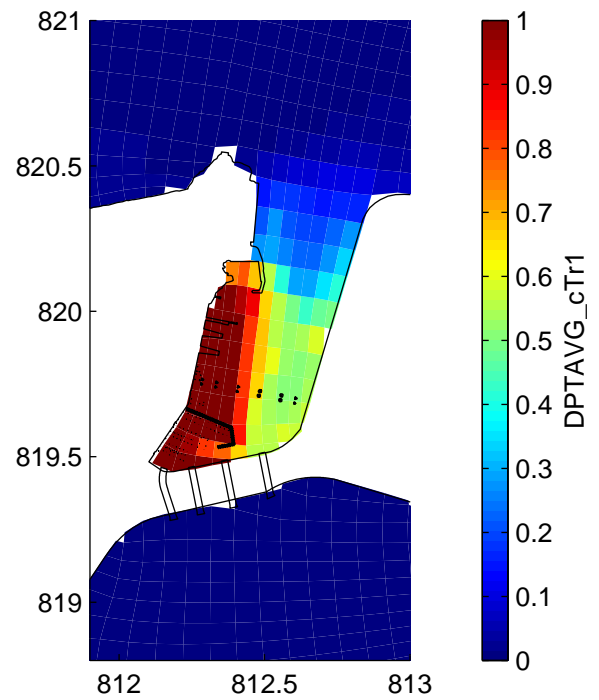
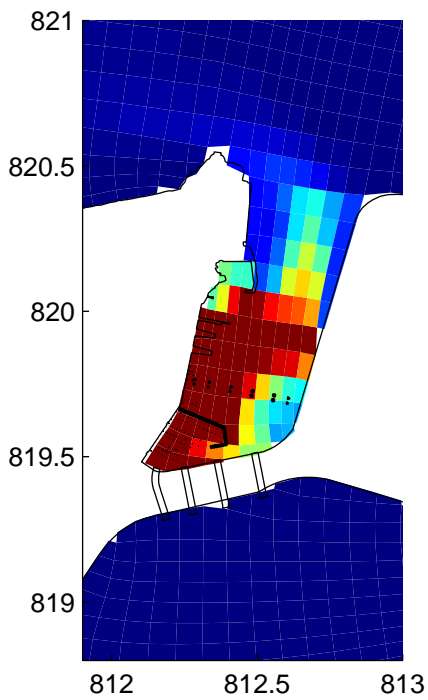
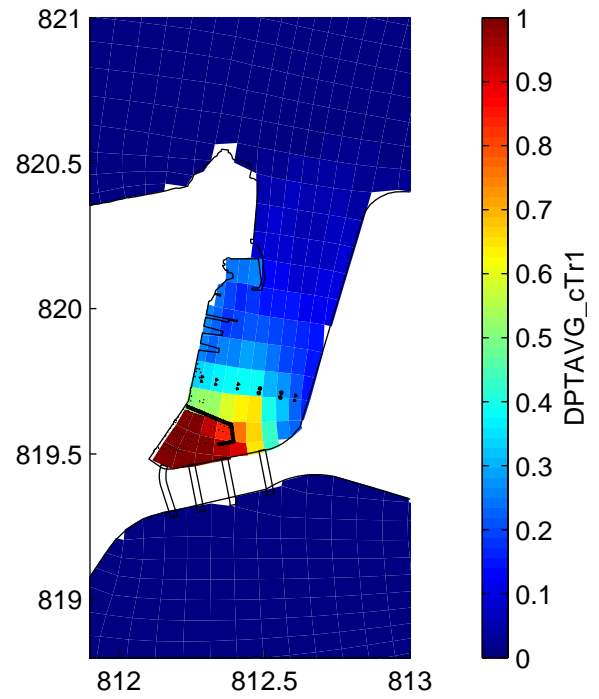
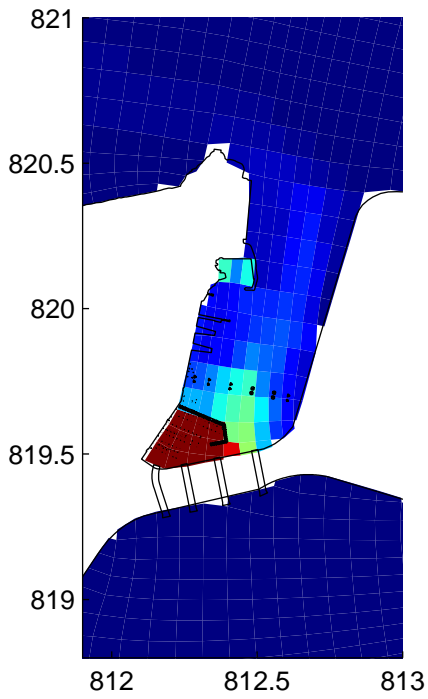

Tracer Concentration During Neap High Water in Wet season at 8hr & 12 hr
 Top: Baseline; Bottom: Project; Left: 8hr; Right: 12hr

0622478

ERM

WQ/Tracer

Tracer₂.fig

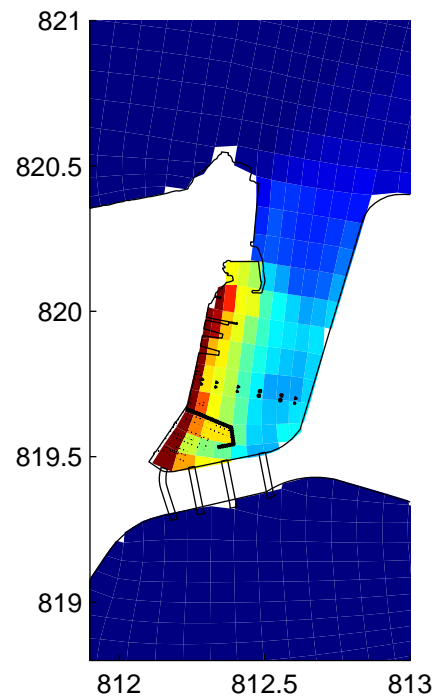
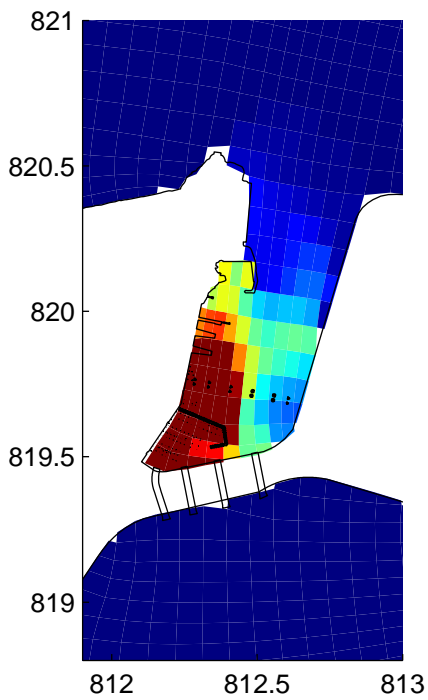
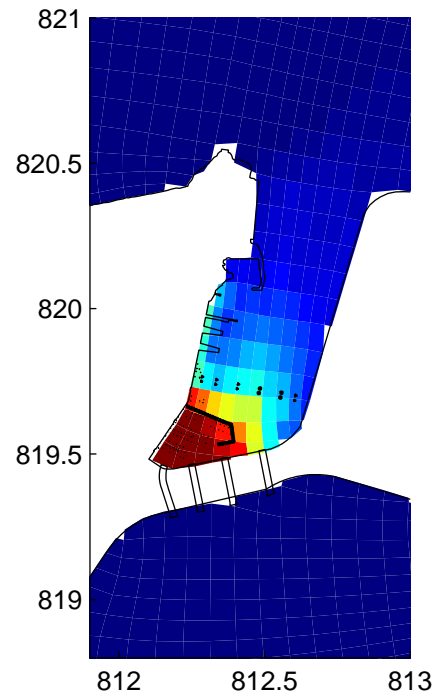
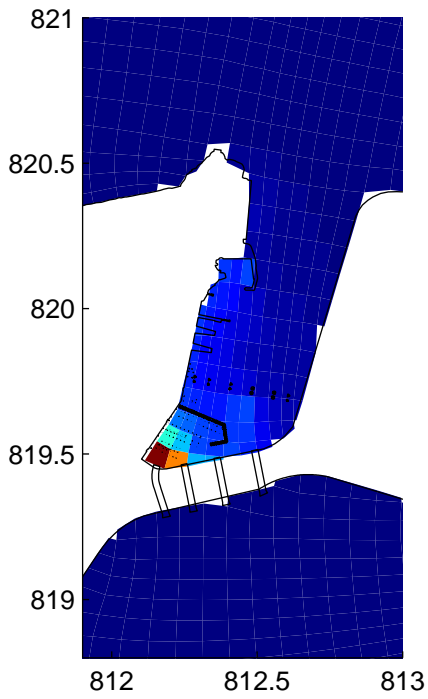

Tracer Concentration During Neap High Water in Wet season at 16hr & 24 hr
 Top: Baseline; Bottom: Project; Left: 16hr; Right: 24hr

0622478

ERM

WQ/Tracer

Tracer₂.fig

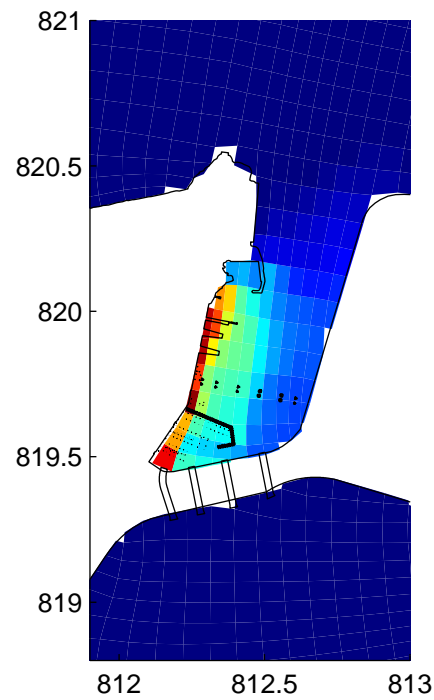
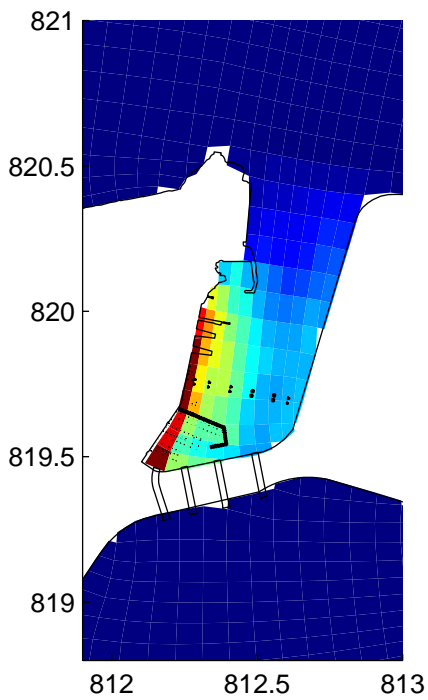
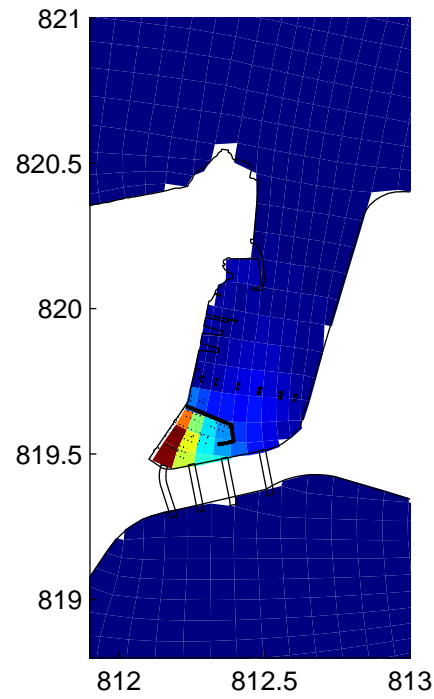
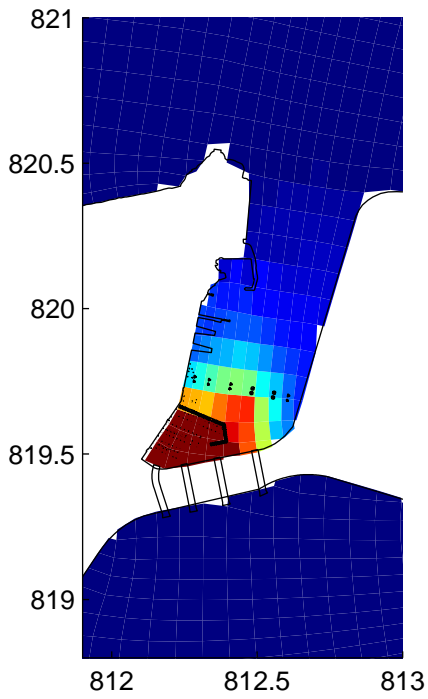

Tracer Concentration During Neap High Water in Wet season at 36hr & 48 hr
 Top: Baseline; Bottom: Project; Left: 36hr; Right: 48hr

0622478

ERM

WQ/Tracer

Tracer₂.fig

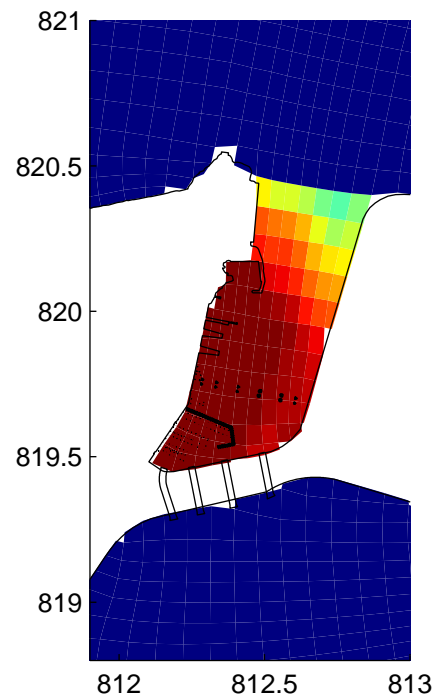
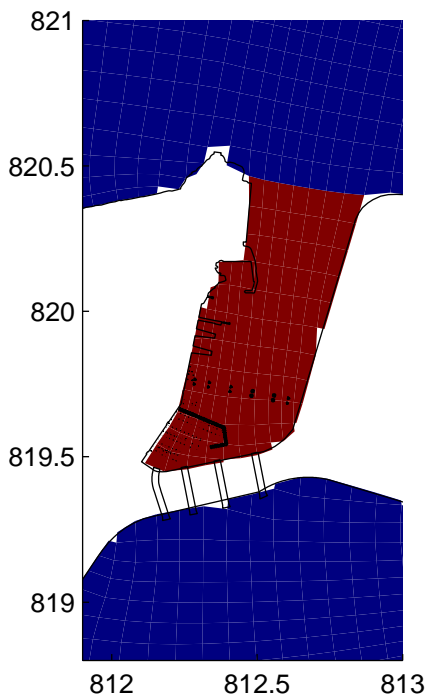
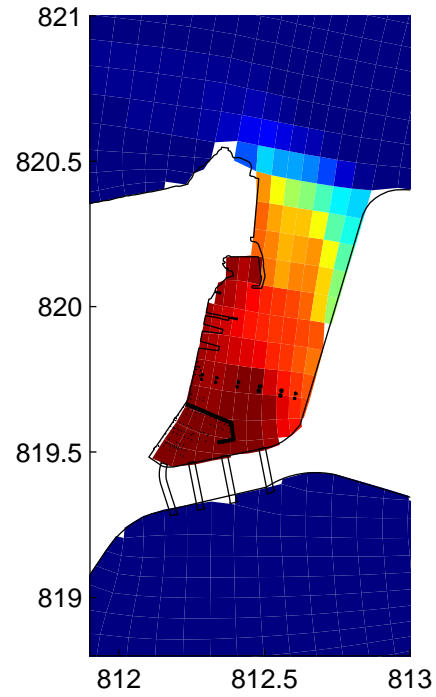
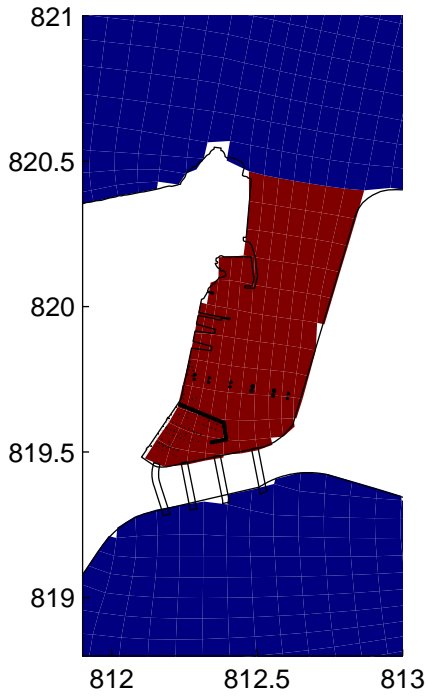

Tracer Concentration During Neap Low Water in Wet season at 0hr & 1 hr
 Top: Baseline; Bottom: Project; Left: 0hr; Right: 1hr

0622478

ERM

WQ/Tracer

Tracer₂.fig

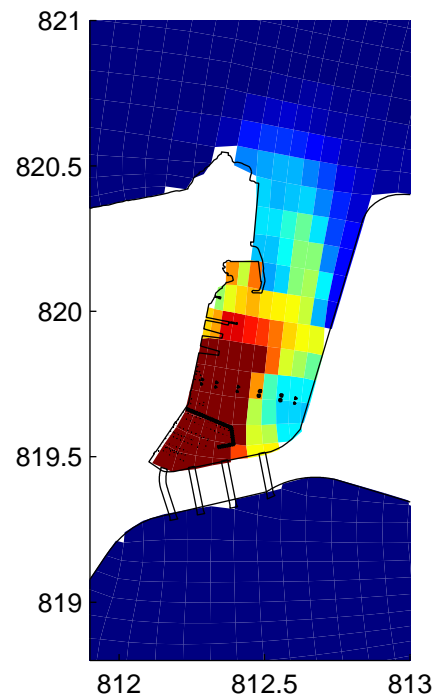
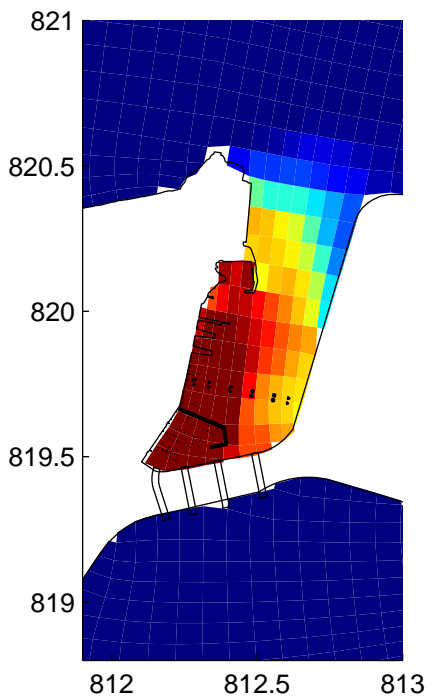
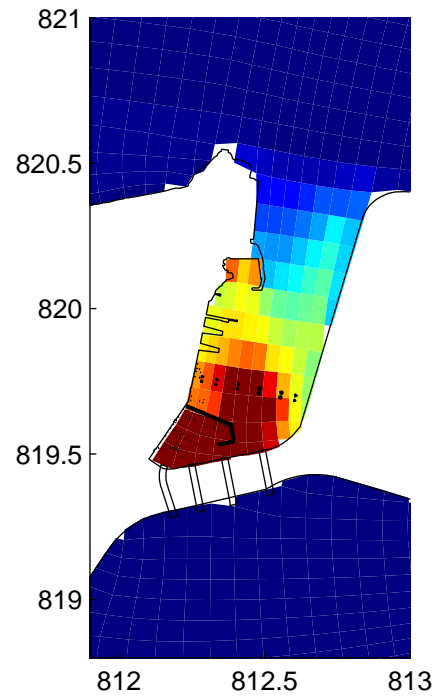
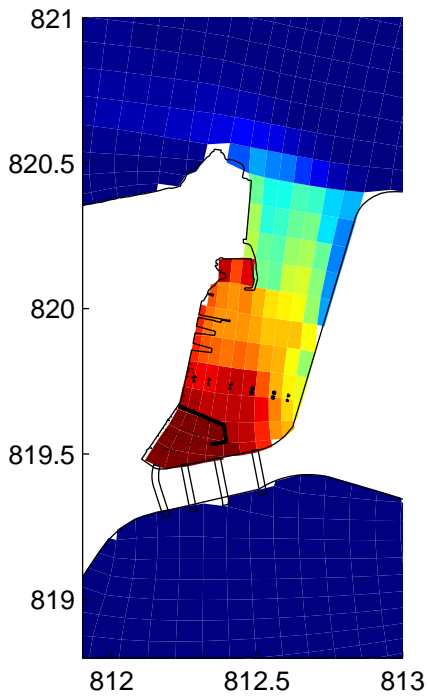

Tracer Concentration During Neap Low Water in Wet season at 2hr & 4 hr
 Top: Baseline; Bottom: Project; Left: 2hr; Right: 4hr

0622478

ERM

WQ/Tracer

Tracer₂.fig

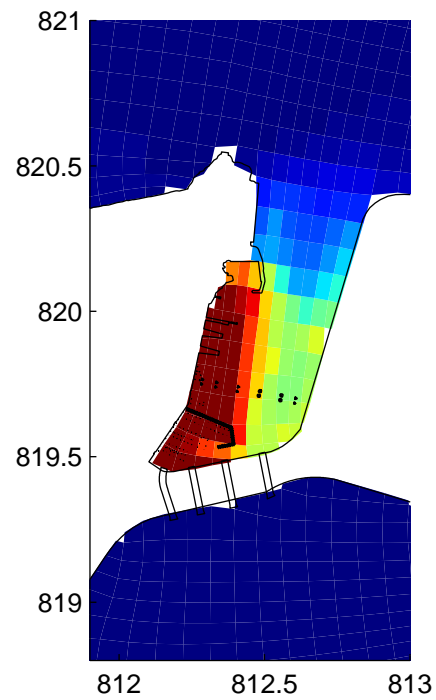
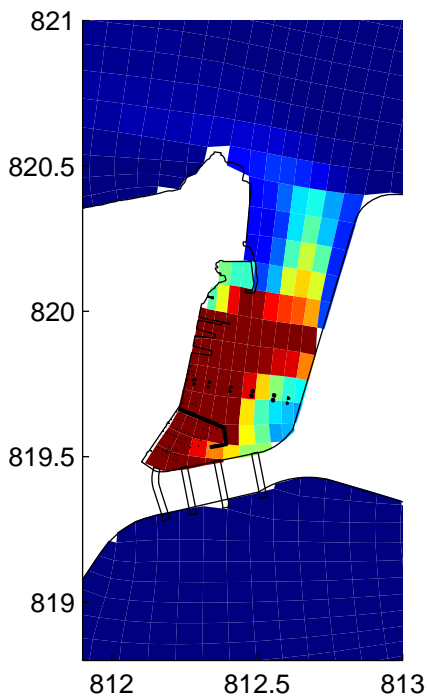
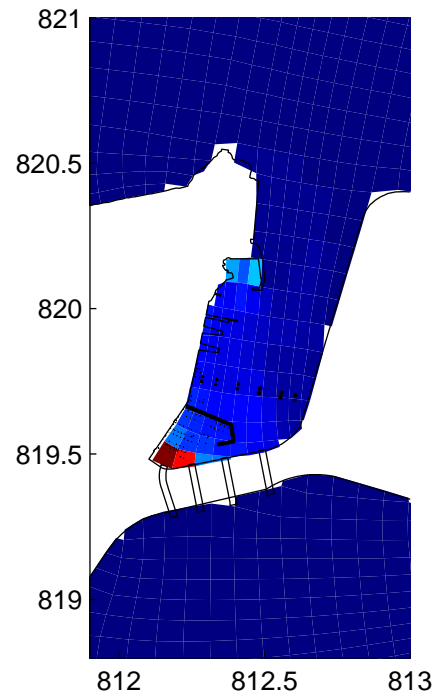
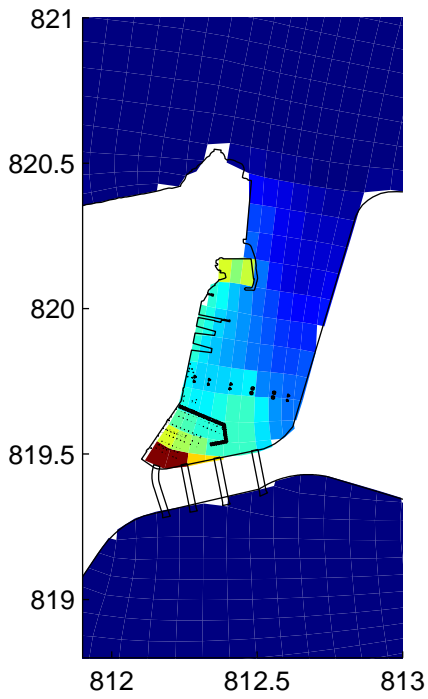

Tracer Concentration During Neap Low Water in Wet season at 8hr & 12 hr
 Top: Baseline; Bottom: Project; Left: 8hr; Right: 12hr

0622478

ERM

WQ/Tracer

Tracer₂.fig

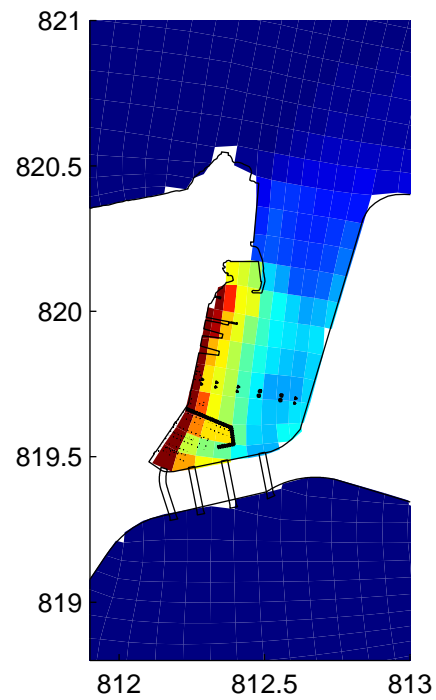
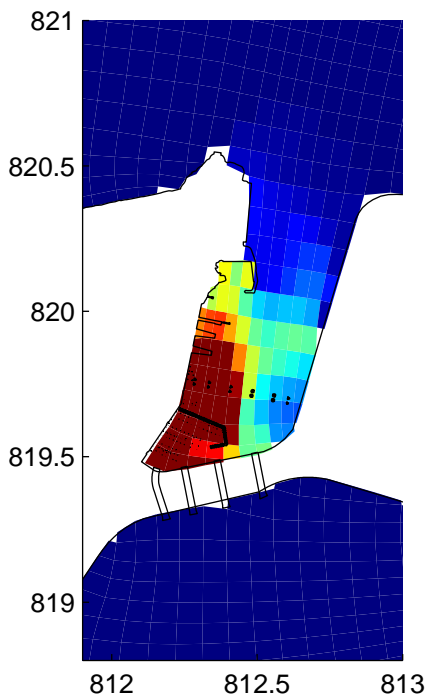
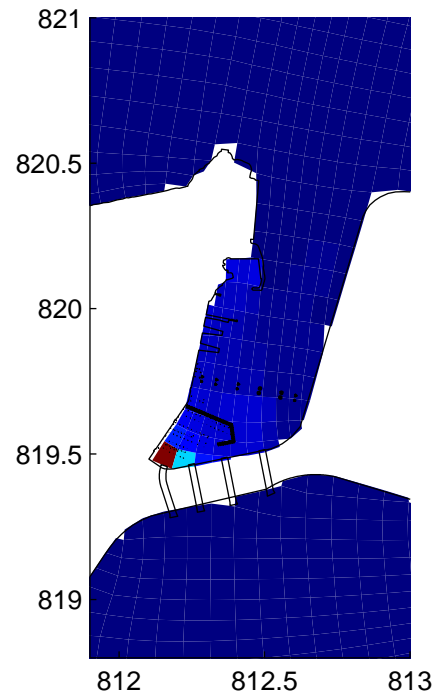
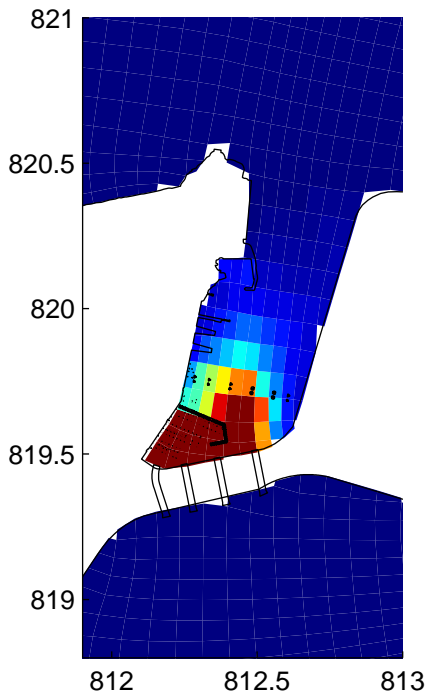

Tracer Concentration During Neap Low Water in Wet season at 16hr & 24 hr
 Top: Baseline; Bottom: Project; Left: 16hr; Right: 24hr

0622478

ERM

WQ/Tracer

Tracer₂.fig

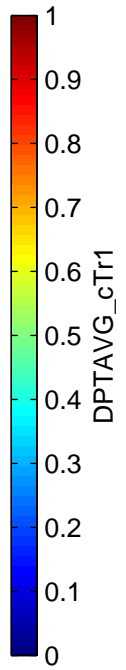
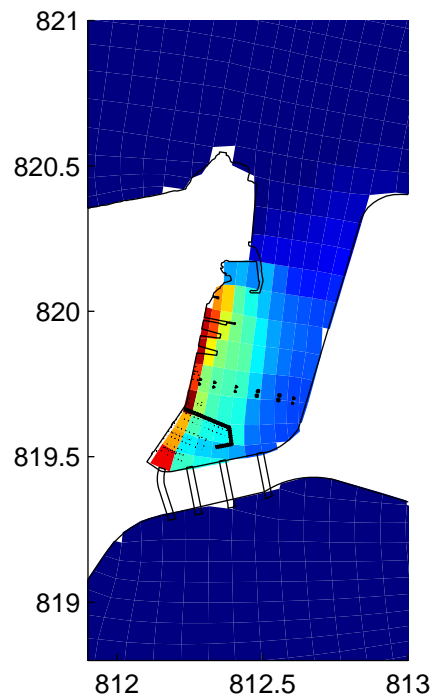
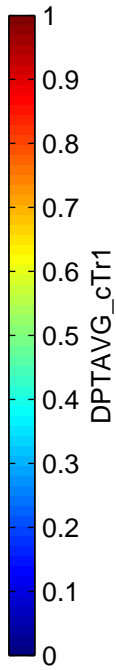
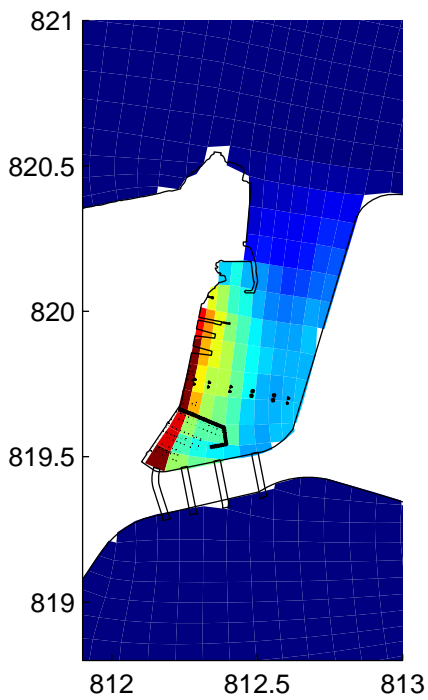
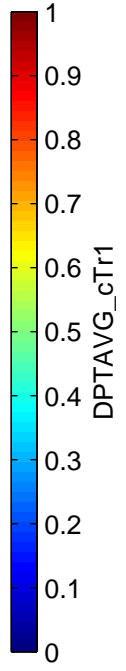
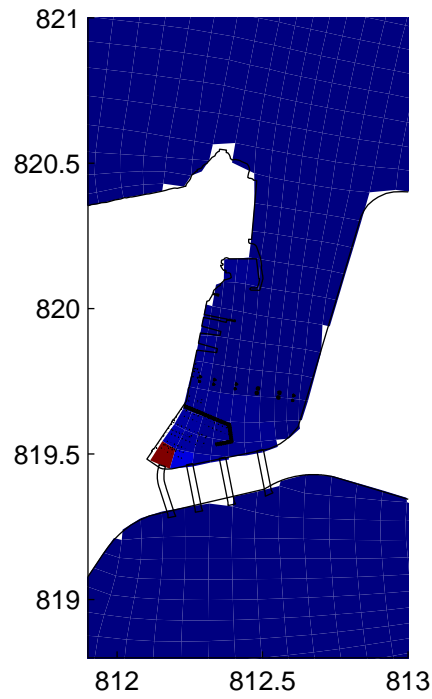
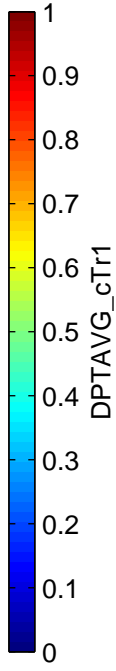
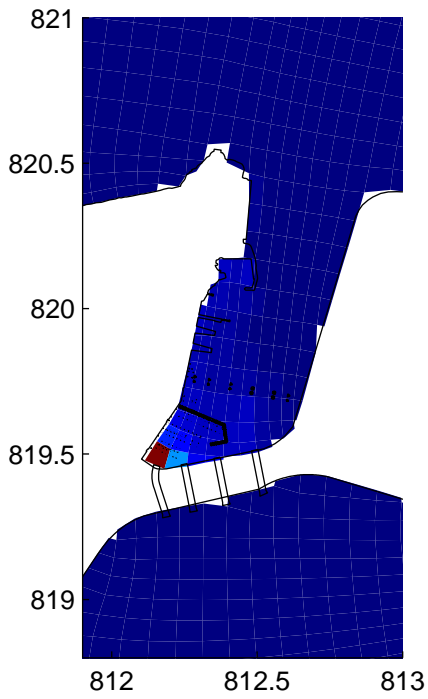

Tracer Concentration During Neap Low Water in Wet season at 36hr & 48 hr
 Top: Baseline; Bottom: Project; Left: 36hr; Right: 48hr

0622478

ERM

WQ/Tracer

Tracer₂.fig

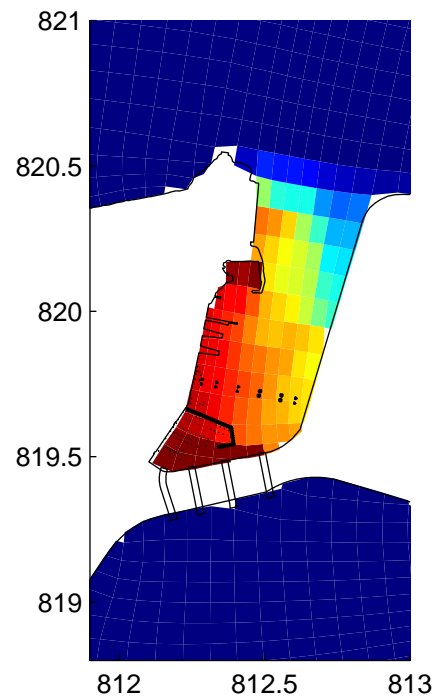
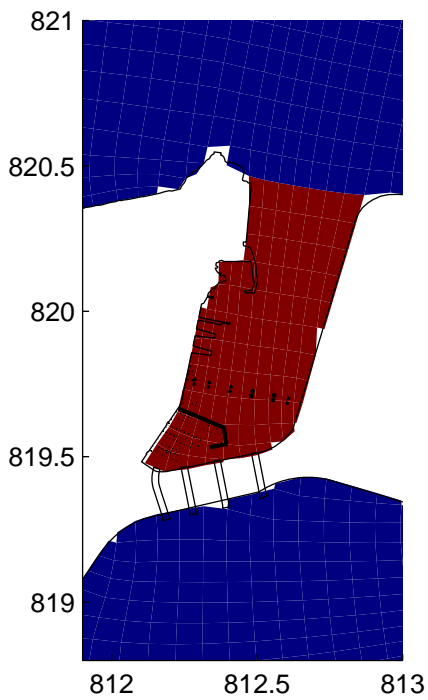
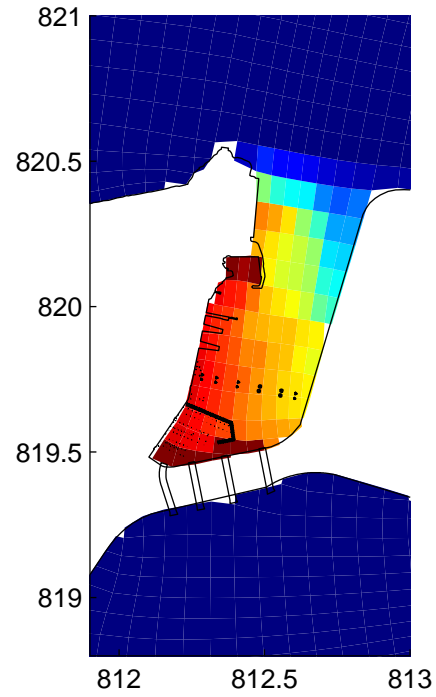
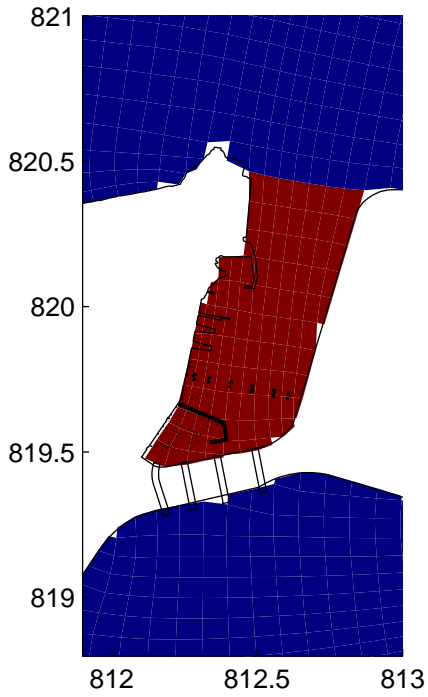

Tracer Concentration During Spring Ebb Tide in Wet season at 0hr & 1 hr
 Top: Baseline; Bottom: Project; Left: 0hr; Right: 1hr

0622478

ERM

WQ/Tracer

Tracer₂.fig

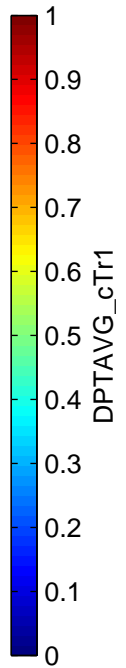
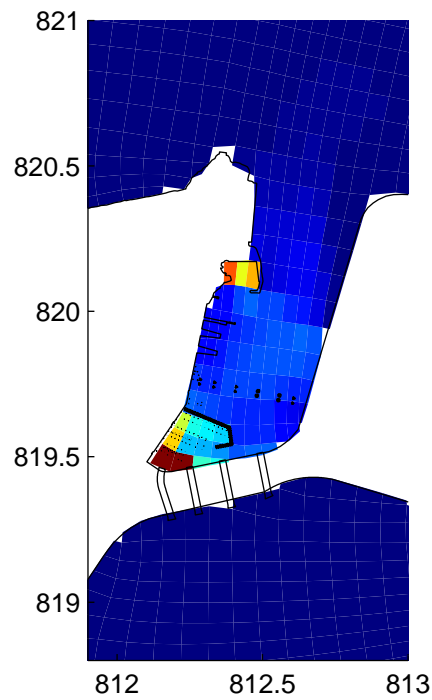
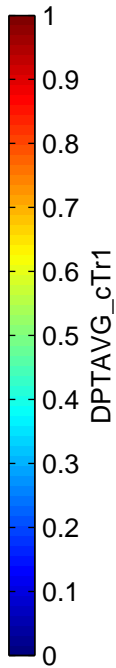
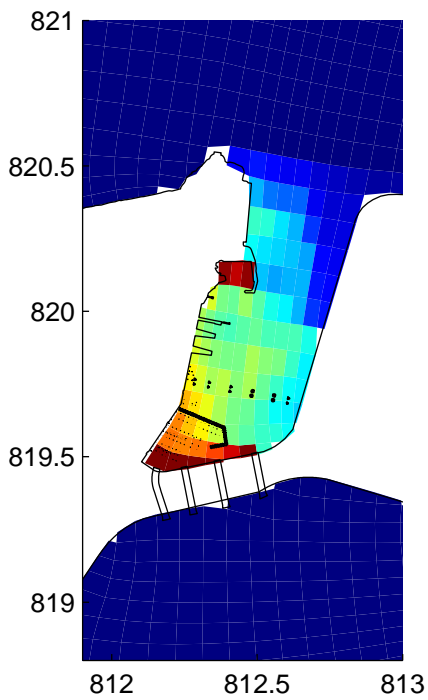
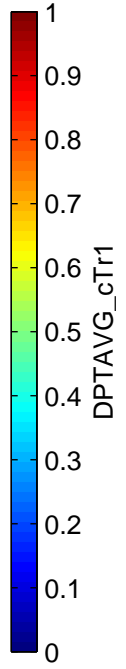
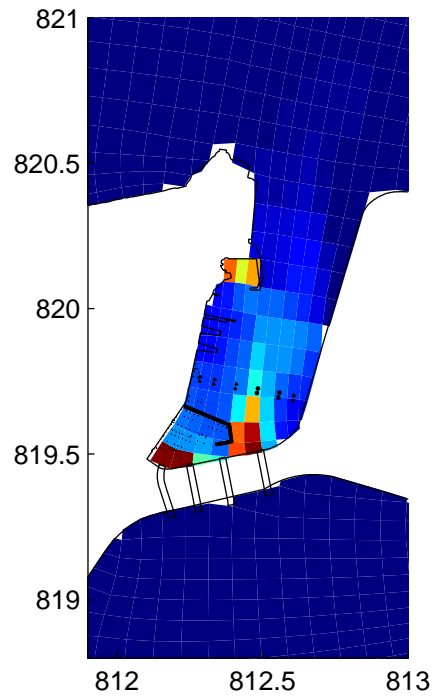
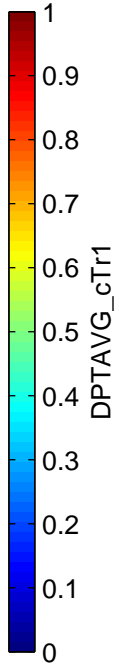
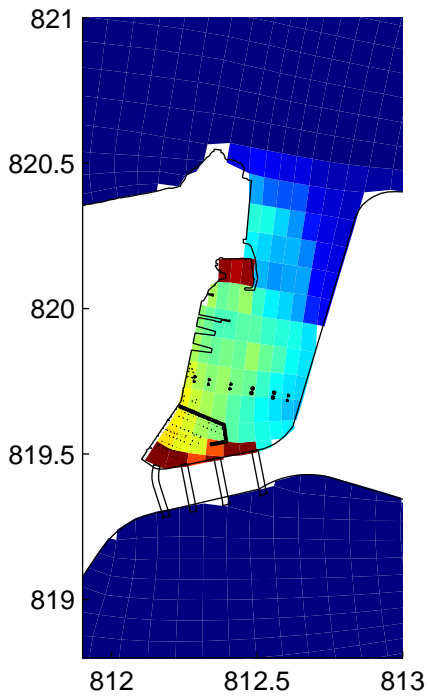

Tracer Concentration During Spring Ebb Tide in Wet season at 2hr & 4 hr
 Top: Baseline; Bottom: Project; Left: 2hr; Right: 4hr

0622478

ERM

WQ/Tracer

Tracer₂.fig

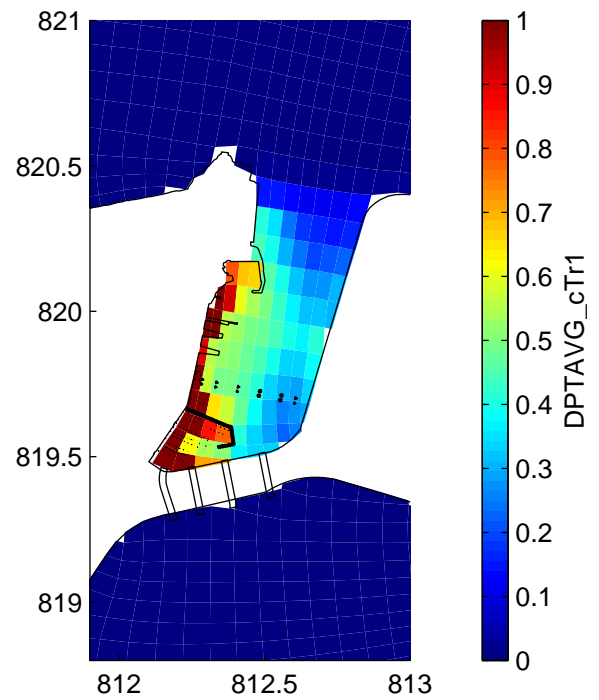
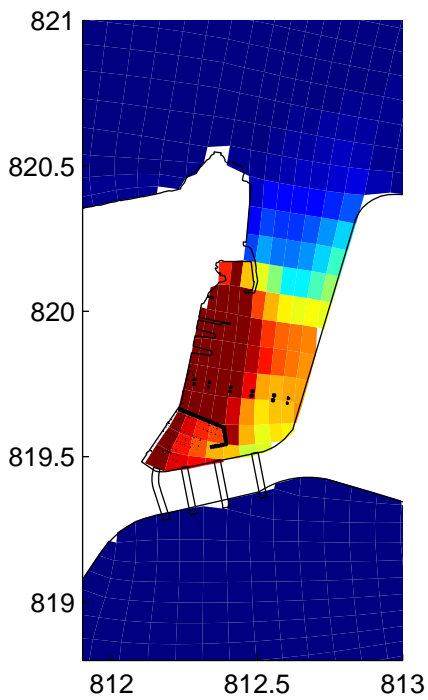
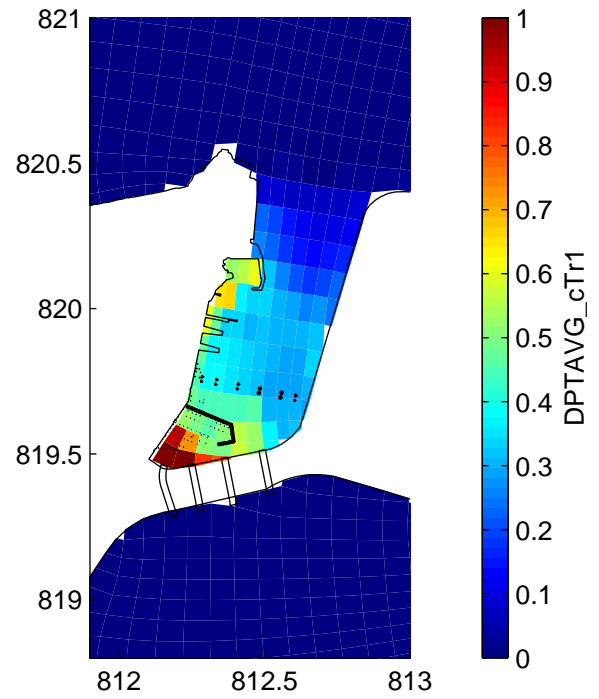
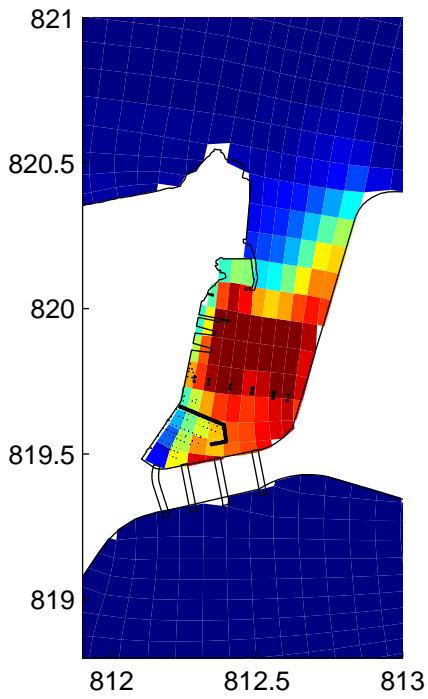

Tracer Concentration During Spring Ebb Tide in Wet season at 8hr & 12 hr
 Top: Baseline; Bottom: Project; Left: 8hr; Right: 12hr

0622478

ERM

WQ/Tracer

Tracer₂.fig

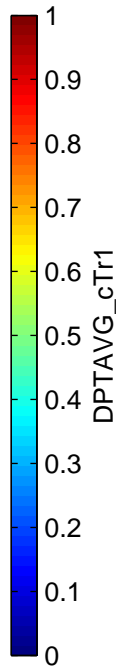
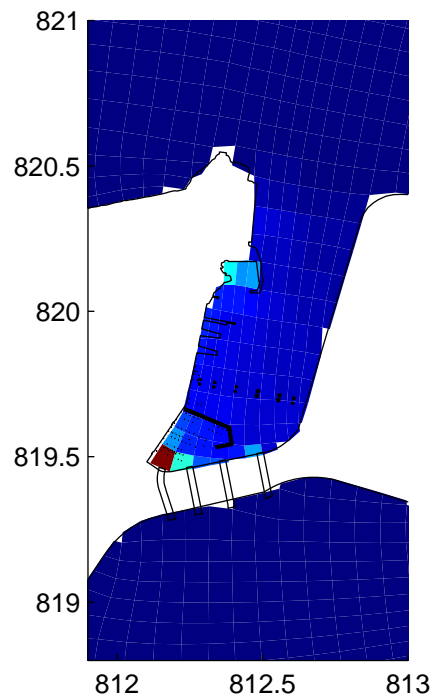
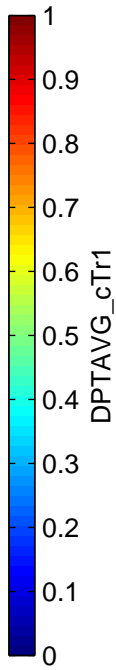
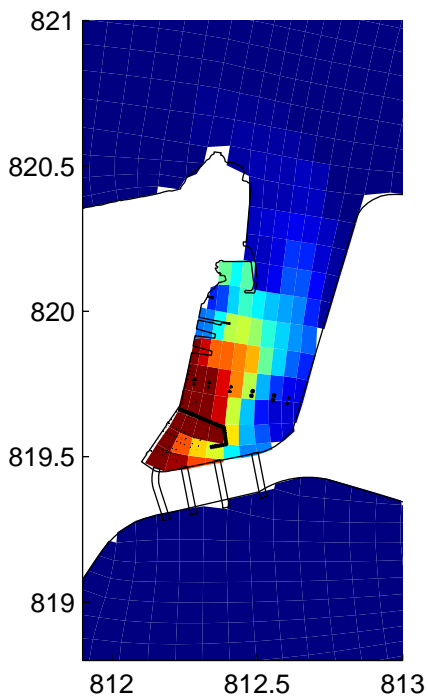
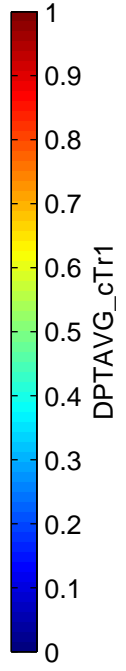
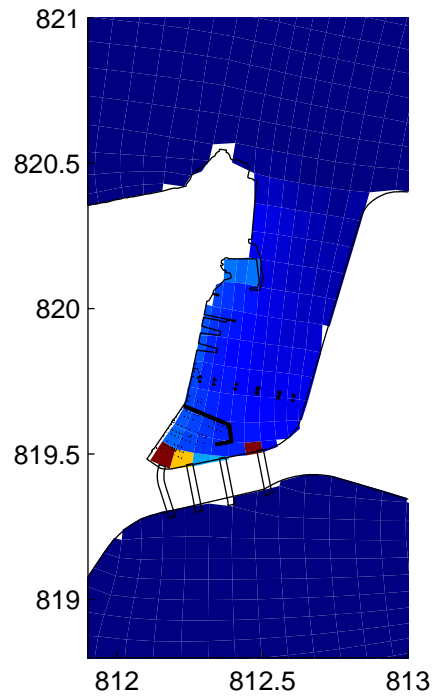
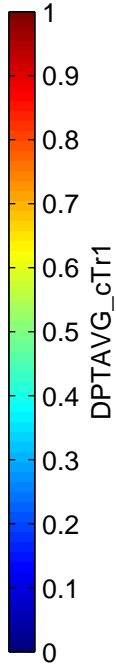
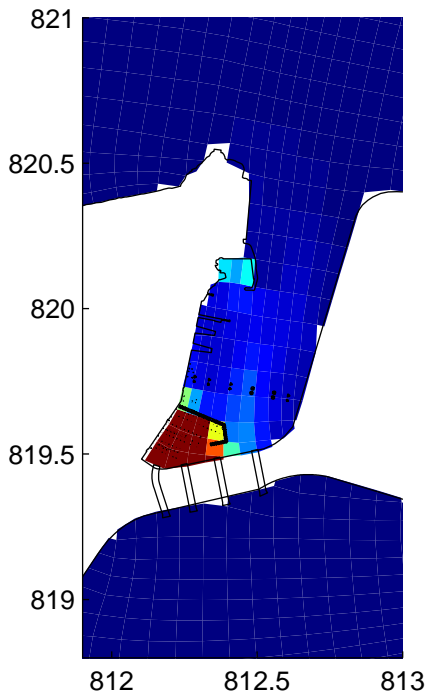

Tracer Concentration During Spring Ebb Tide in Wet season at 16hr & 24 hr
 Top: Baseline; Bottom: Project; Left: 16hr; Right: 24hr

0622478

ERM

WQ/Tracer

Tracer₂.fig

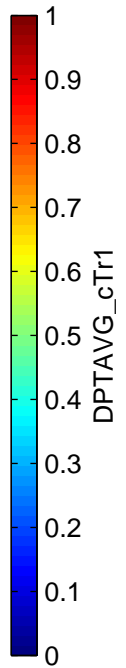
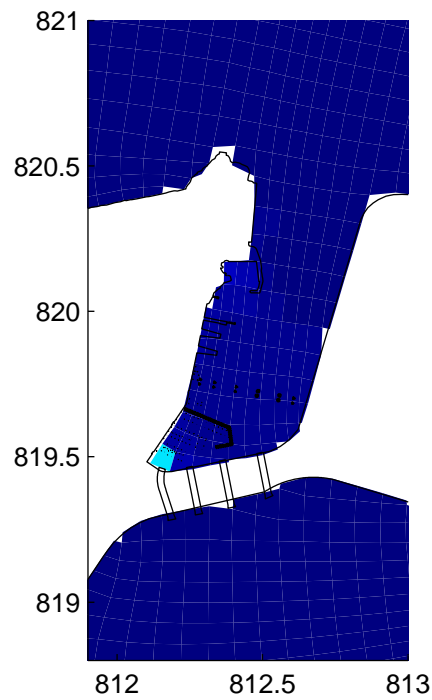
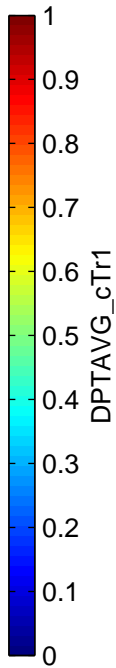
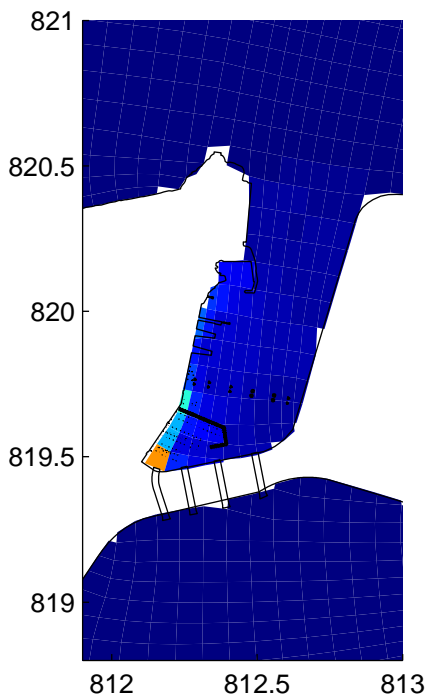
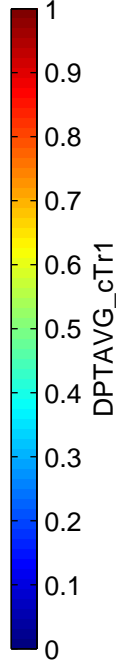
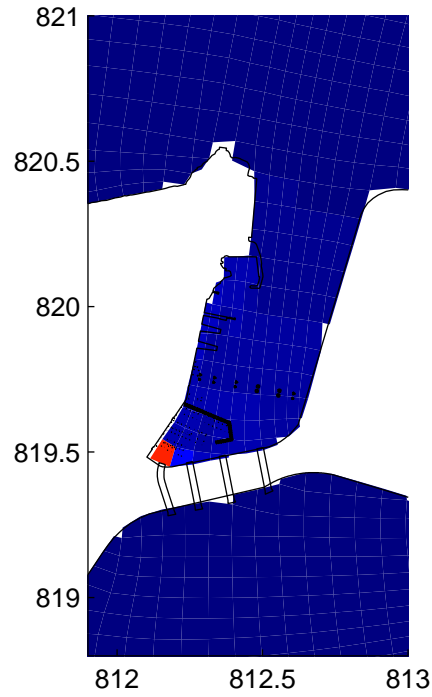
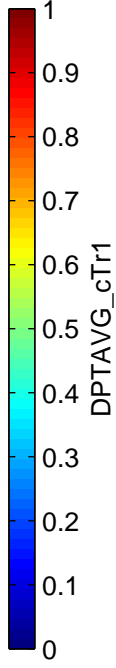
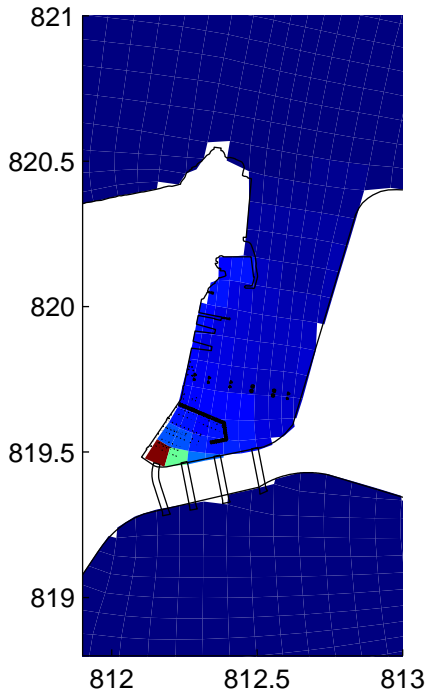

Tracer Concentration During Spring Ebb Tide in Wet season at 36hr & 48 hr
 Top: Baseline; Bottom: Project; Left: 36hr; Right: 48hr

0622478

ERM

WQ/Tracer

Tracer₂.fig

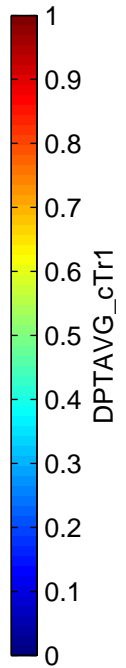
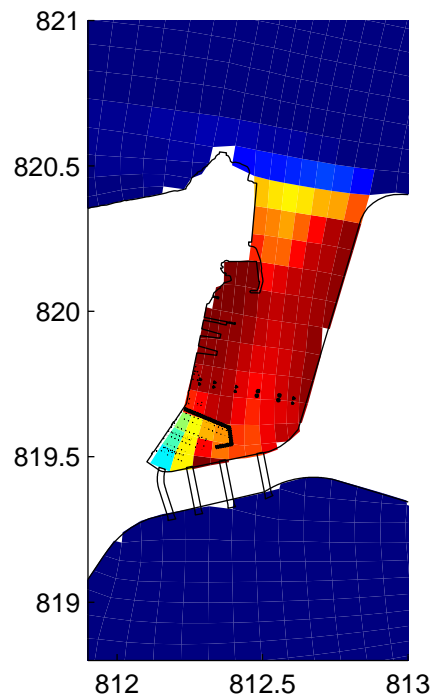
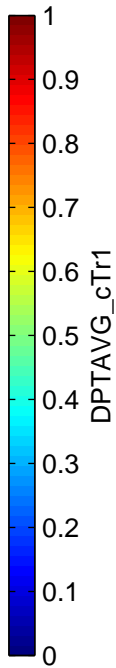
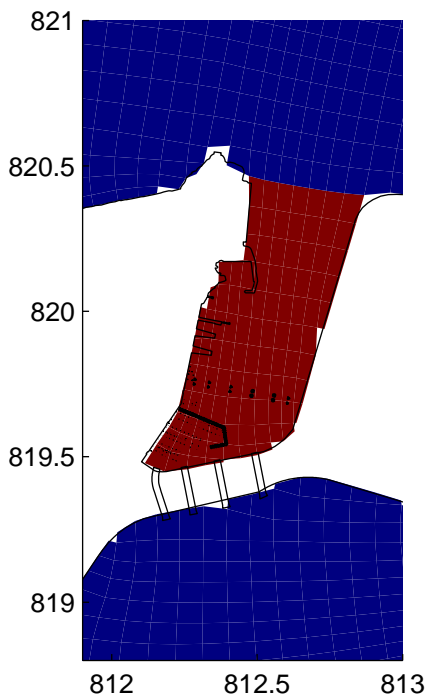
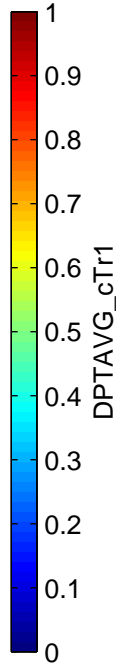
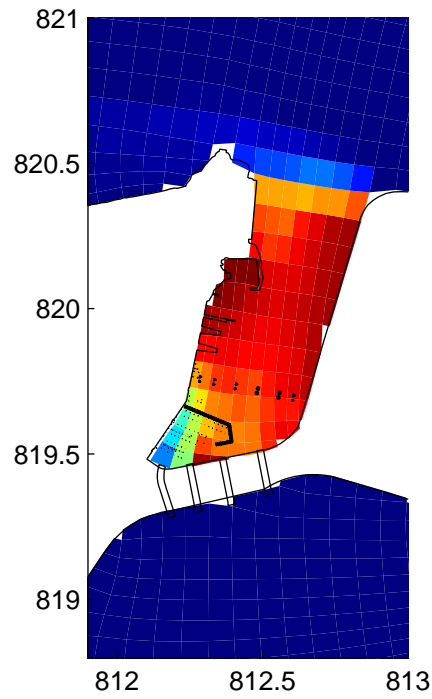
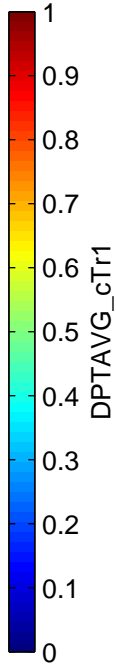
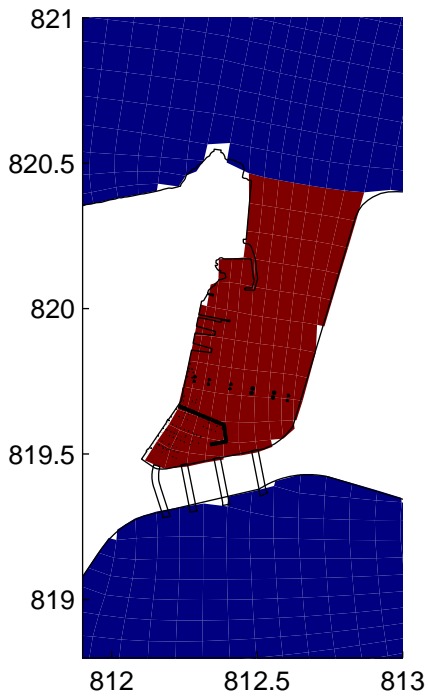

Tracer Concentration During Spring Flood Tide in Wet season at 0hr & 1 hr
 Top: Baseline; Bottom: Project; Left: 0hr; Right: 1hr

0622478

ERM

WQ/Tracer

Tracer₂.fig

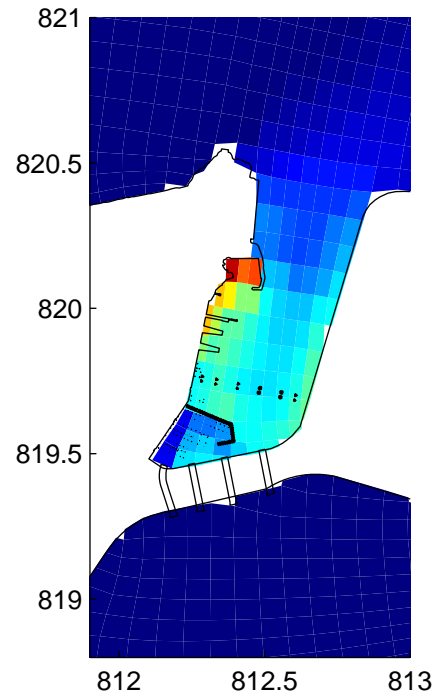
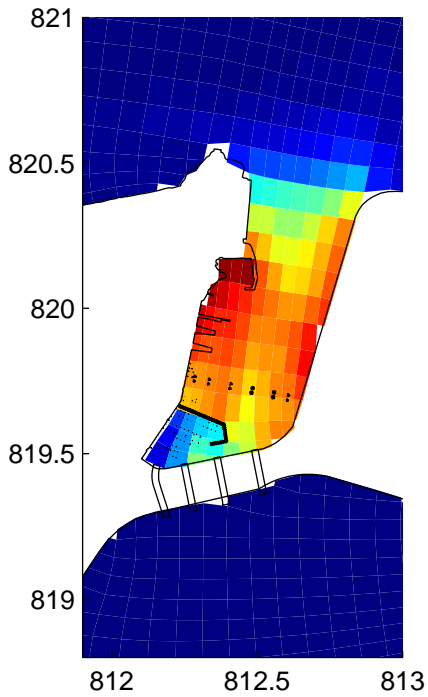
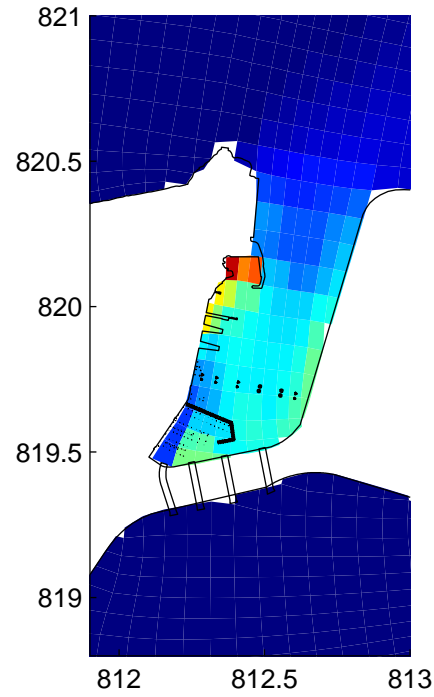
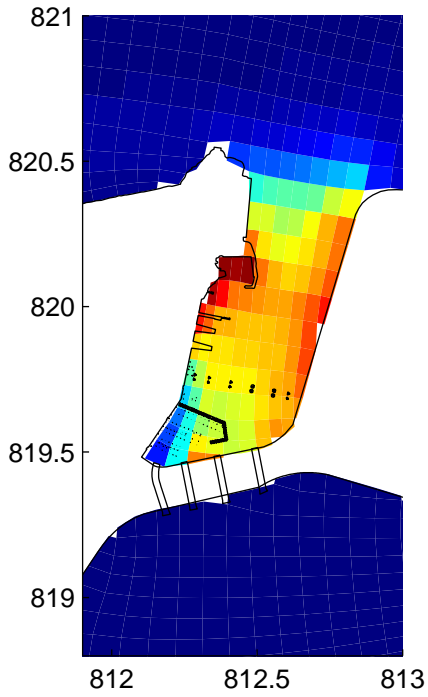

Tracer Concentration During Spring Flood Tide in Wet season at 2hr & 4 hr
 Top: Baseline; Bottom: Project; Left: 2hr; Right: 4hr

0622478

ERM

WQ/Tracer

Tracer₂.fig

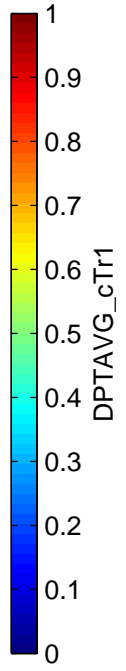
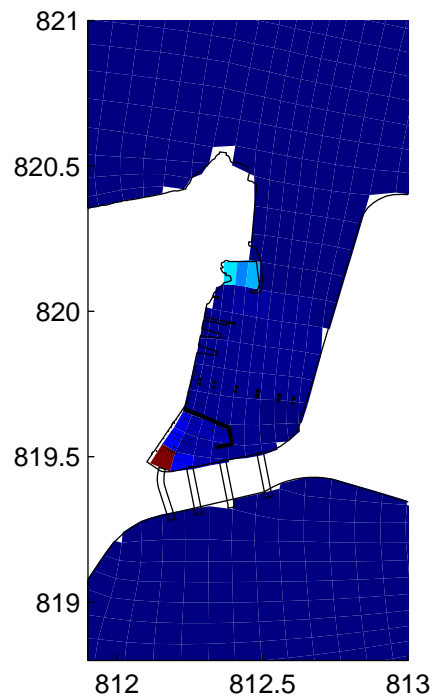
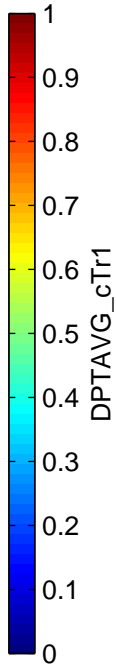
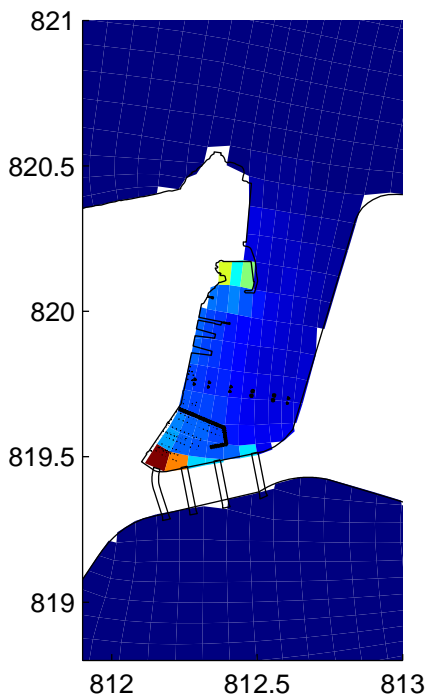
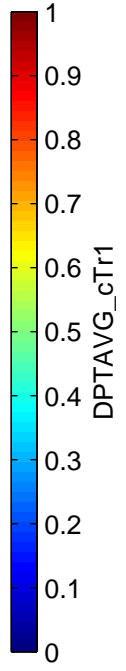
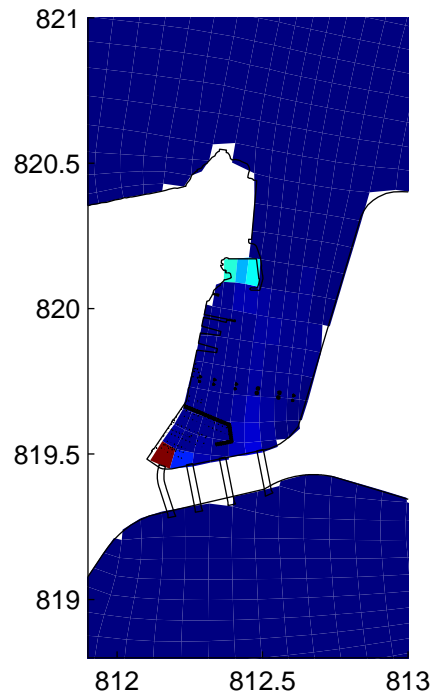
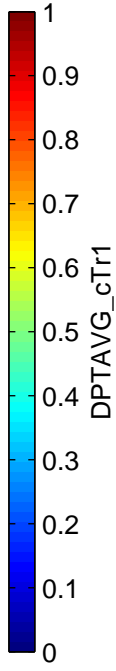
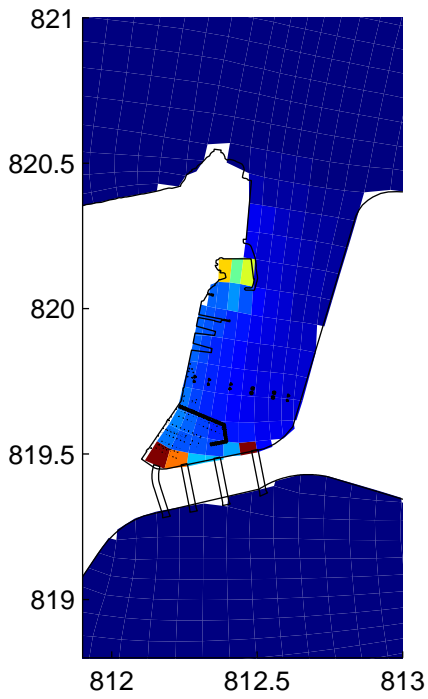

Tracer Concentration During Spring Flood Tide in Wet season at 8hr & 12 hr
 Top: Baseline; Bottom: Project; Left: 8hr; Right: 12hr

0622478

ERM

WQ/Tracer

Tracer₂.fig

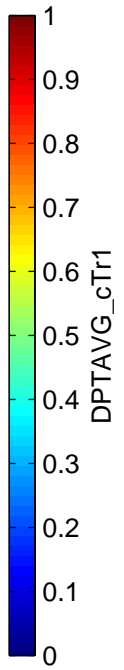
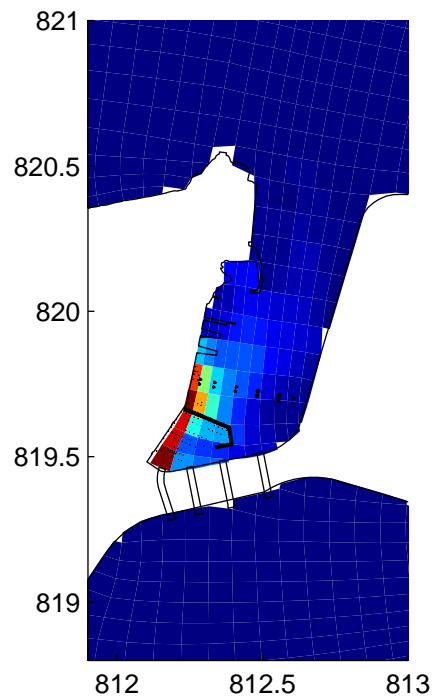
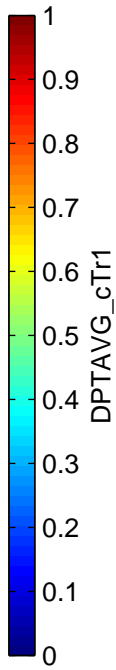
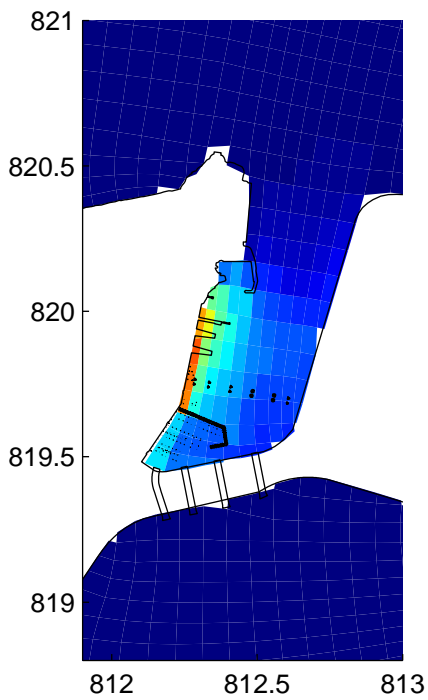
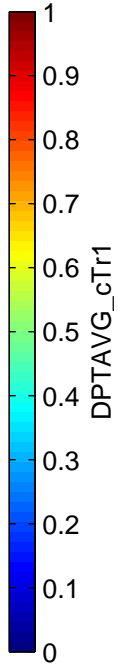
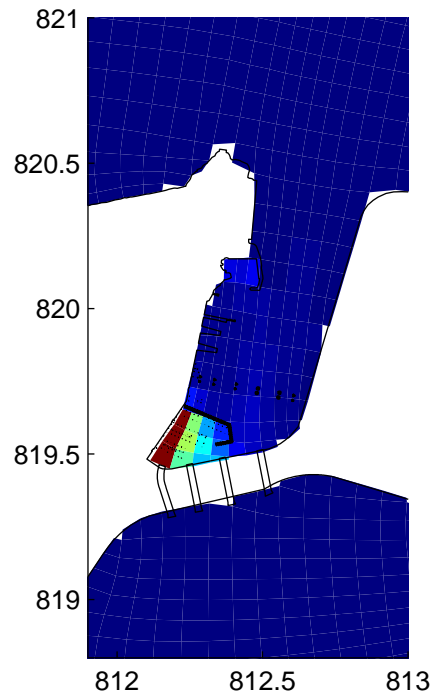
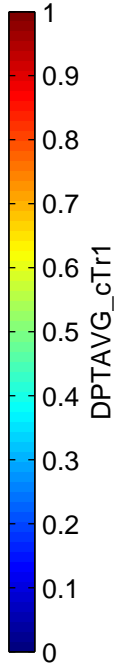
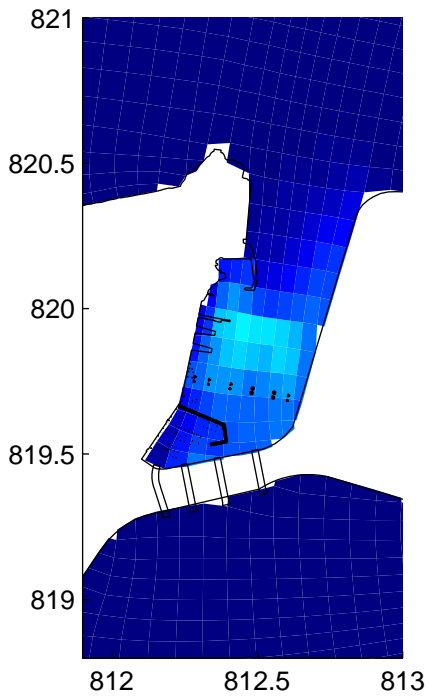

Tracer Concentration During Spring Flood Tide in Wet season at 16hr & 24 hr
 Top: Baseline; Bottom: Project; Left: 16hr; Right: 24hr

0622478

ERM

WQ/Tracer

Tracer₂.fig

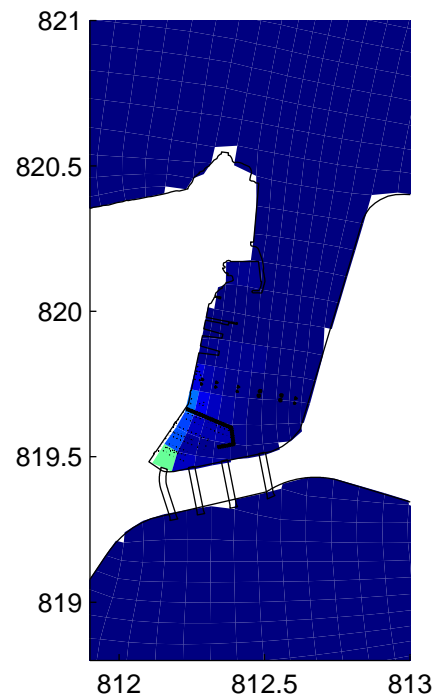
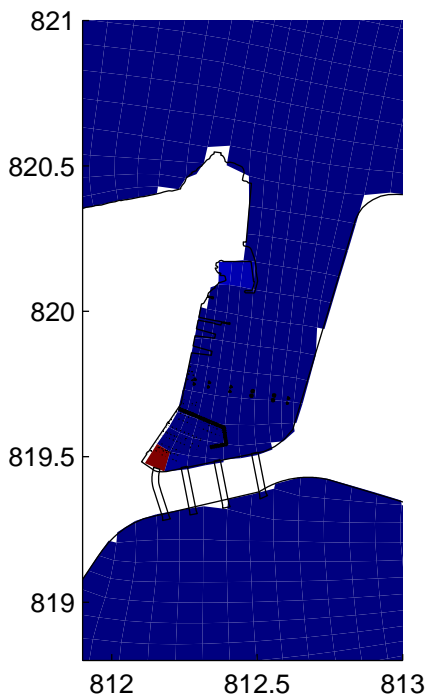
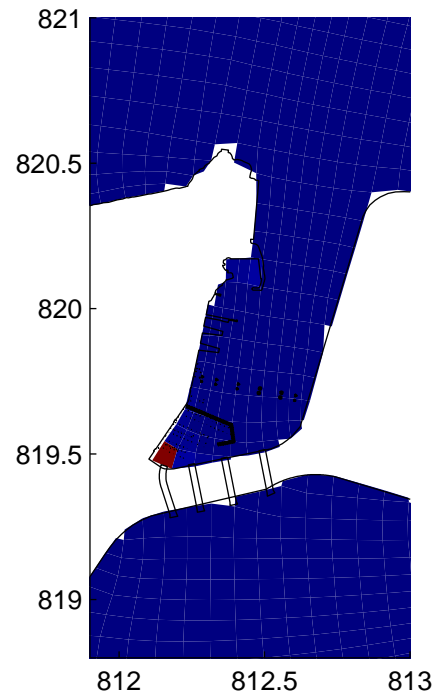
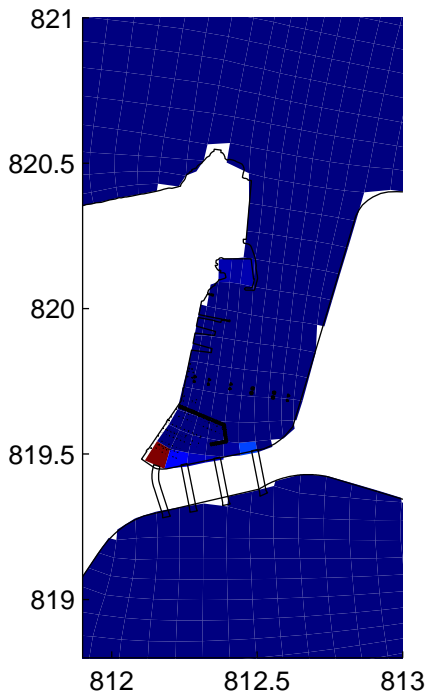

Tracer Concentration During Spring Flood Tide in Wet season at 36hr & 48 hr
 Top: Baseline; Bottom: Project; Left: 36hr; Right: 48hr

0622478

ERM

WQ/Tracer

Tracer₂.fig

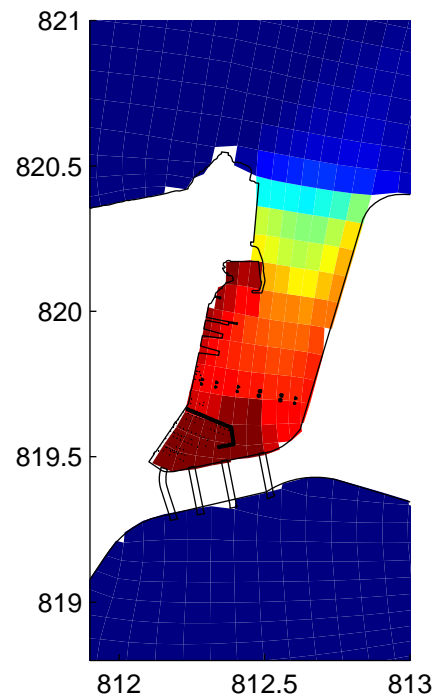
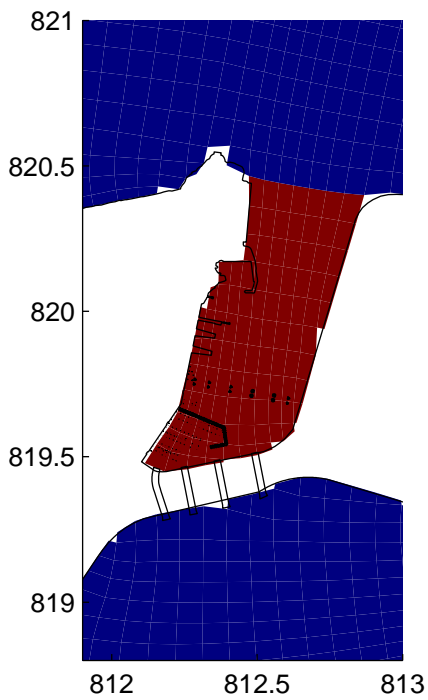
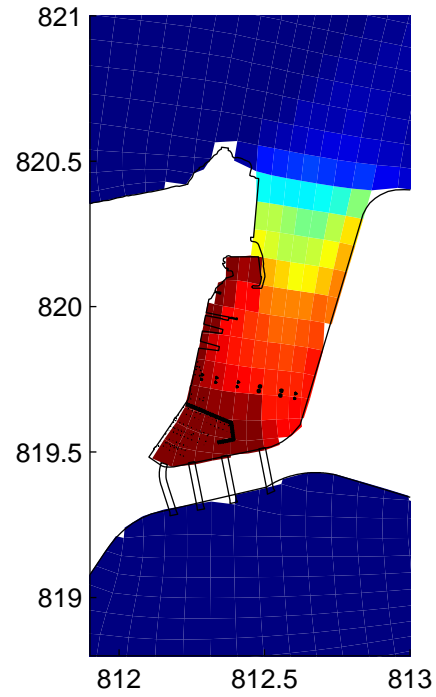
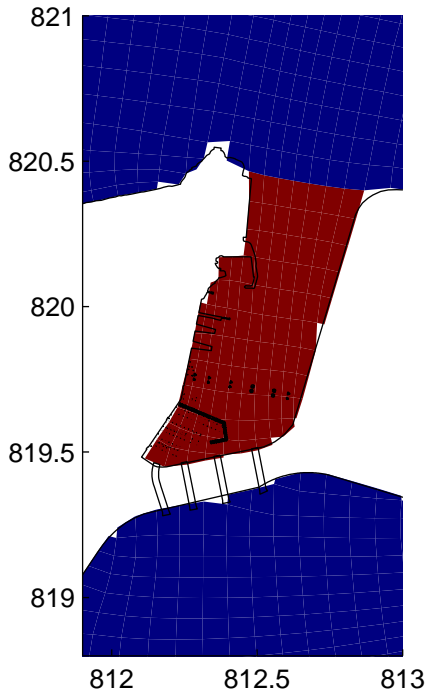

Tracer Concentration During Spring High Water in Wet season at 0hr & 1 hr
 Top: Baseline; Bottom: Project; Left: 0hr; Right: 1hr

0622478

ERM

WQ/Tracer

Tracer₂.fig

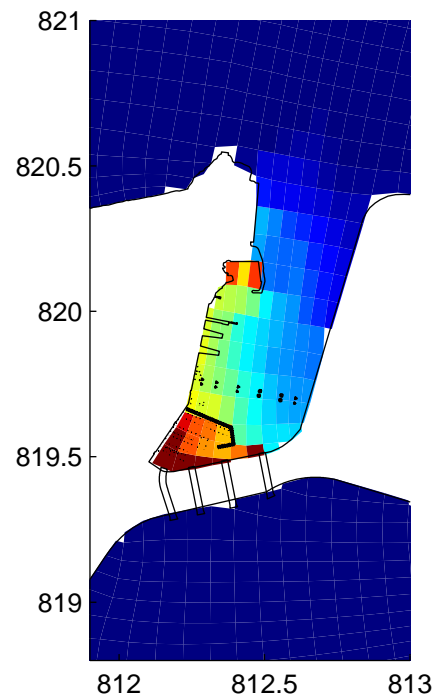
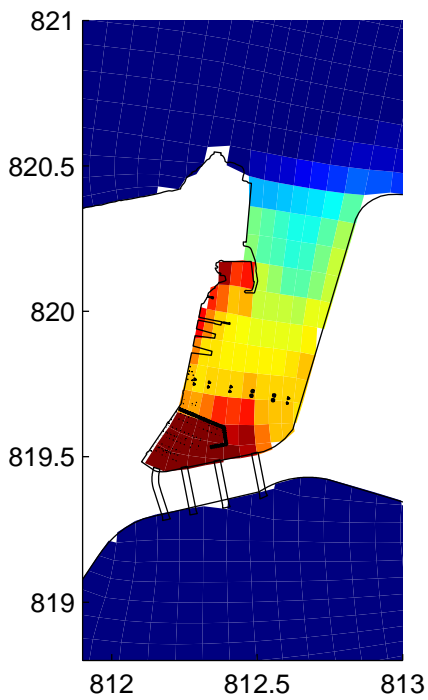
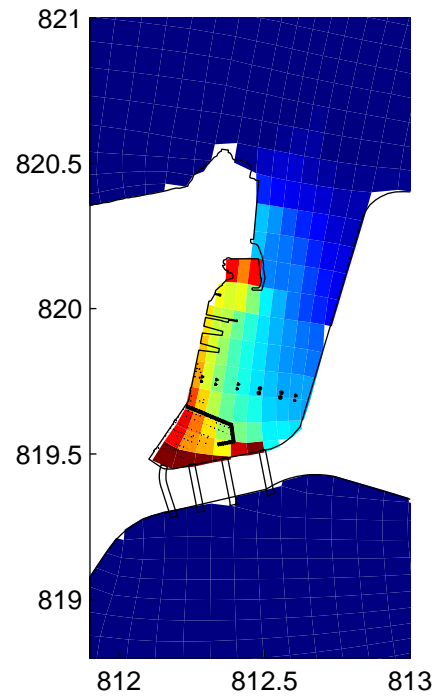
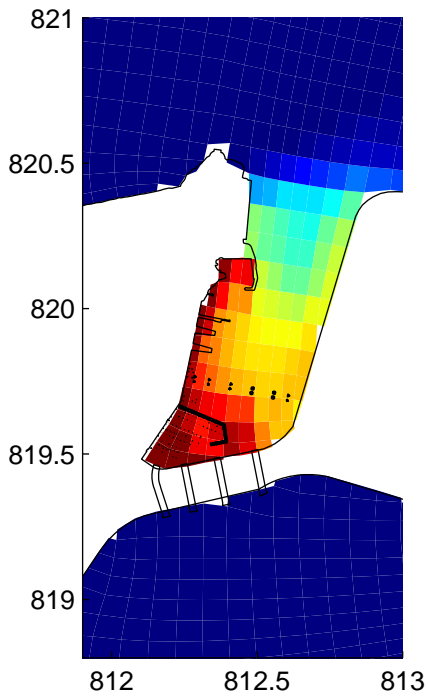

Tracer Concentration During Spring High Water in Wet season at 2hr & 4 hr
 Top: Baseline; Bottom: Project; Left: 2hr; Right: 4hr

0622478

ERM

WQ/Tracer

Tracer₂.fig

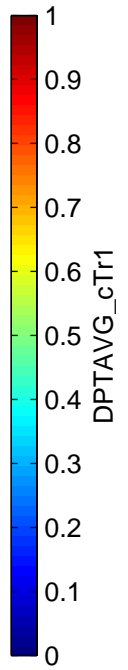
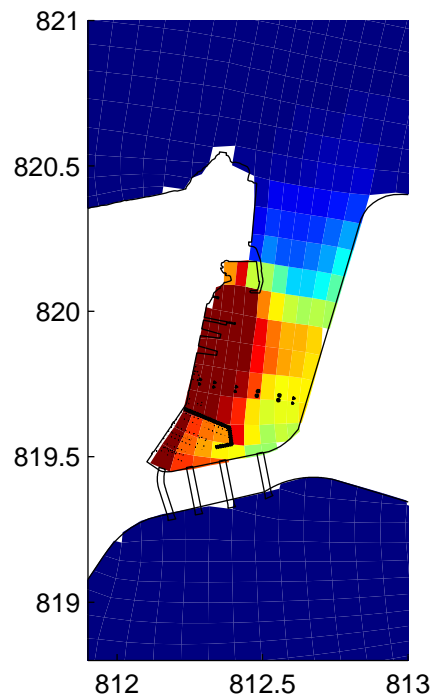
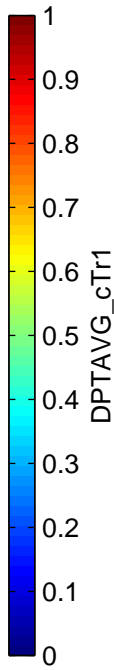
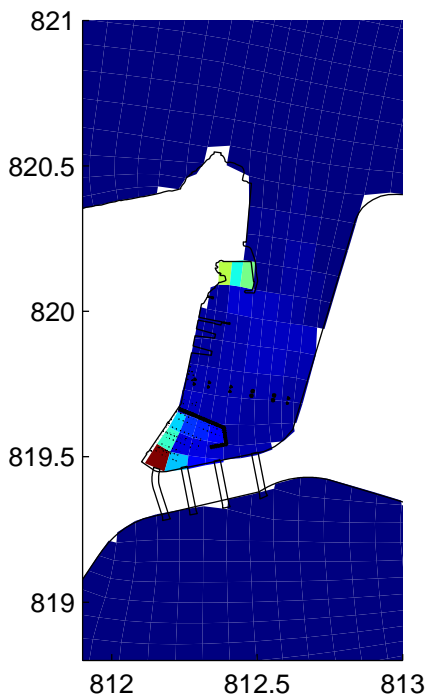
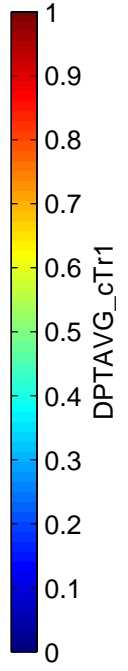
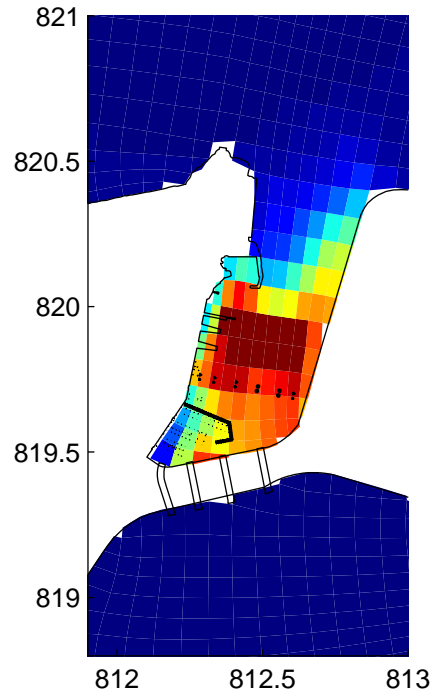
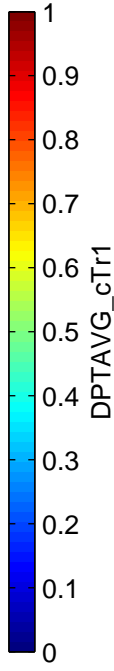
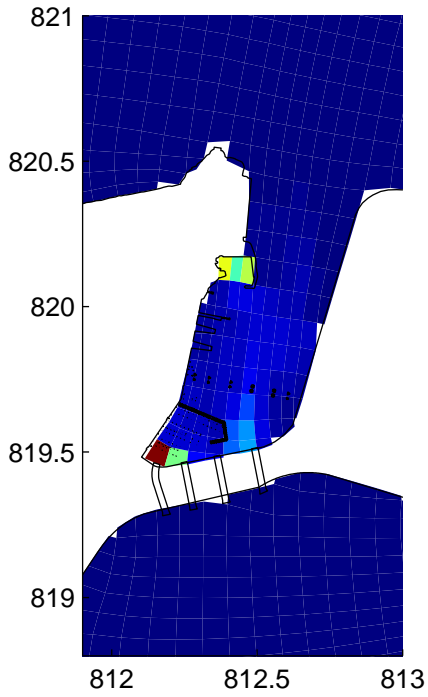

Tracer Concentration During Spring High Water in Wet season at 8hr & 12 hr
 Top: Baseline; Bottom: Project; Left: 8hr; Right: 12hr

0622478

ERM

WQ/Tracer

Tracer₂.fig

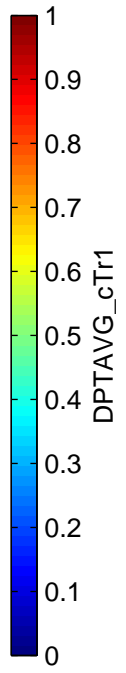
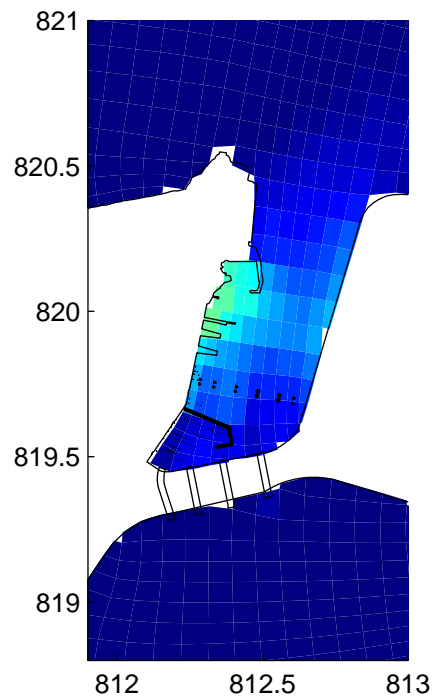
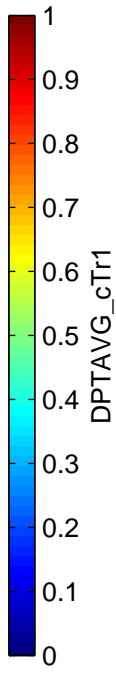
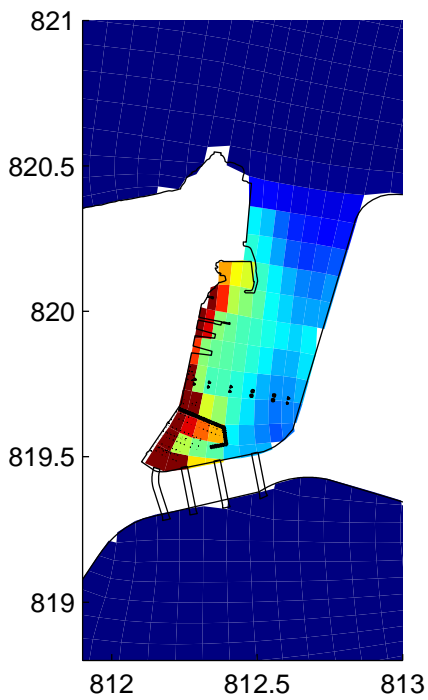
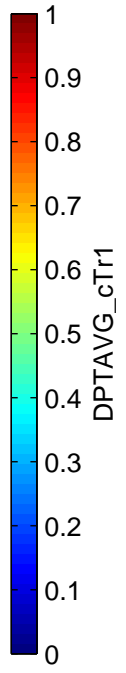
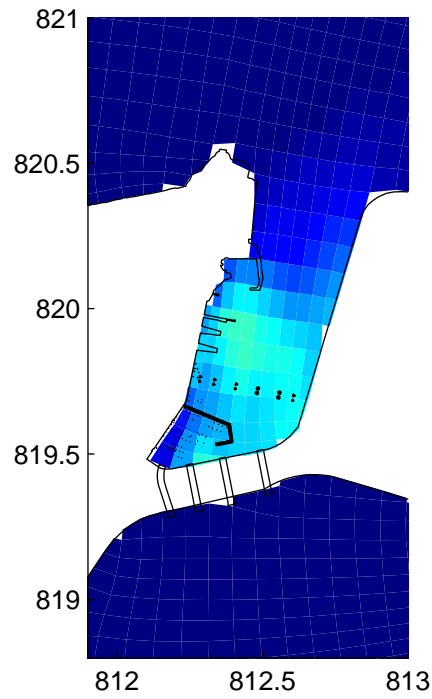
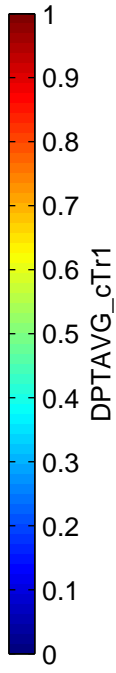
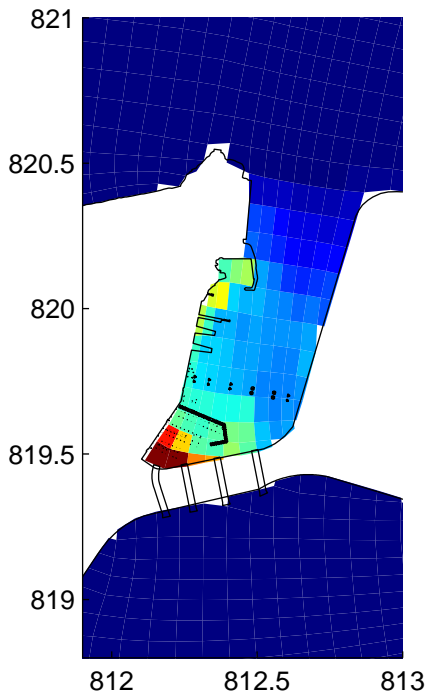

Tracer Concentration During Spring High Water in Wet season at 16hr & 24 hr
 Top: Baseline; Bottom: Project; Left: 16hr; Right: 24hr

0622478

ERM

WQ/Tracer

Tracer₂.fig

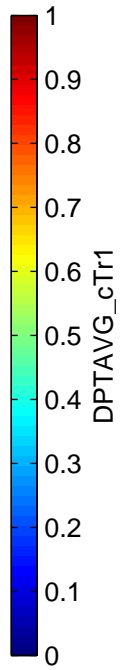
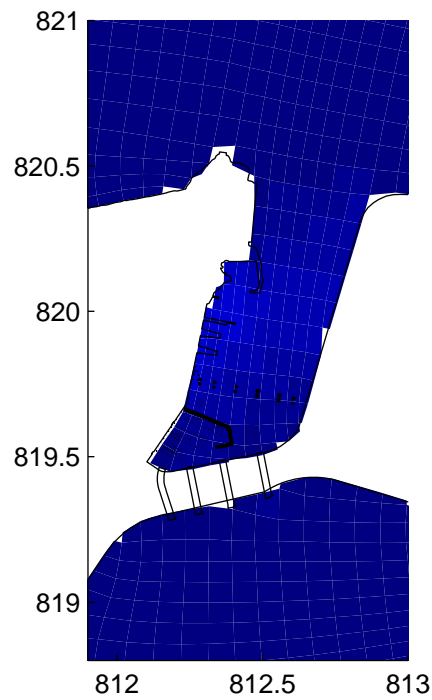
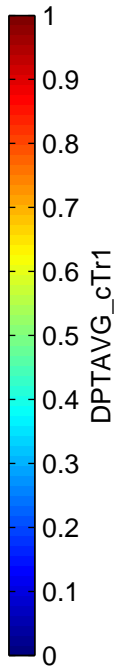
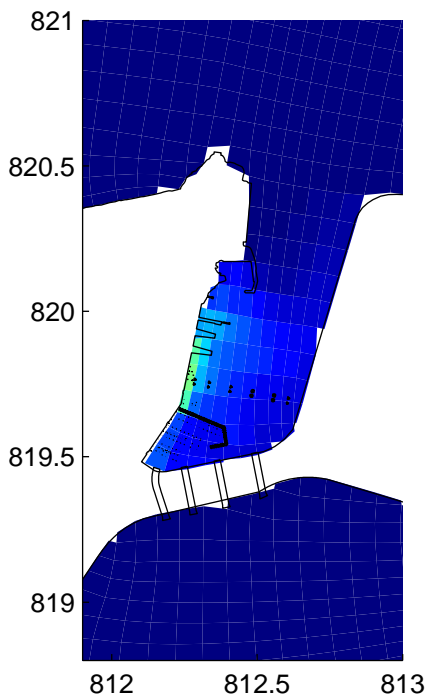
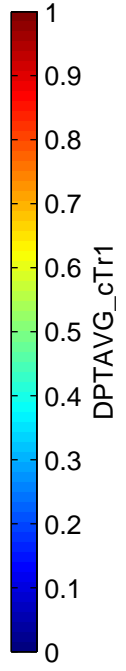
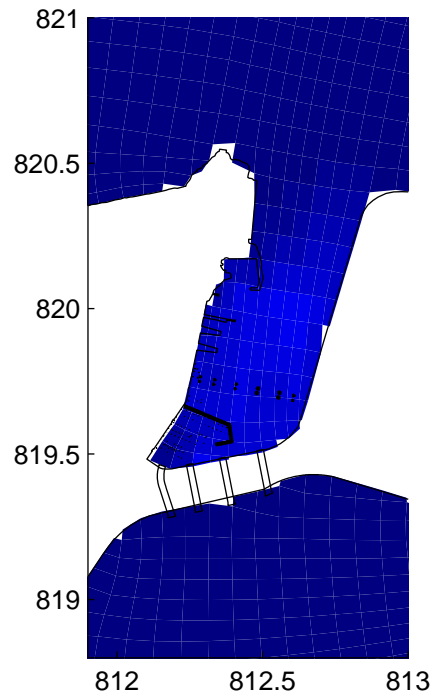
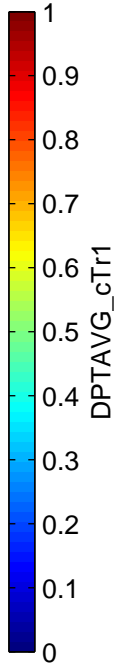
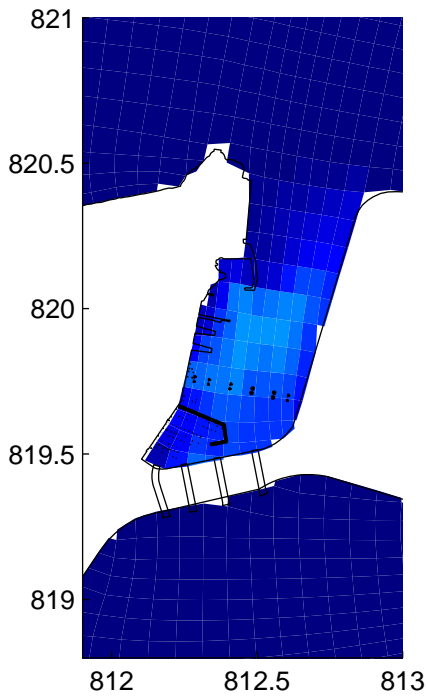

Tracer Concentration During Spring High Water in Wet season at 36hr & 48 hr
 Top: Baseline; Bottom: Project; Left: 36hr; Right: 48hr

0622478

ERM

WQ/Tracer

Tracer₂.fig

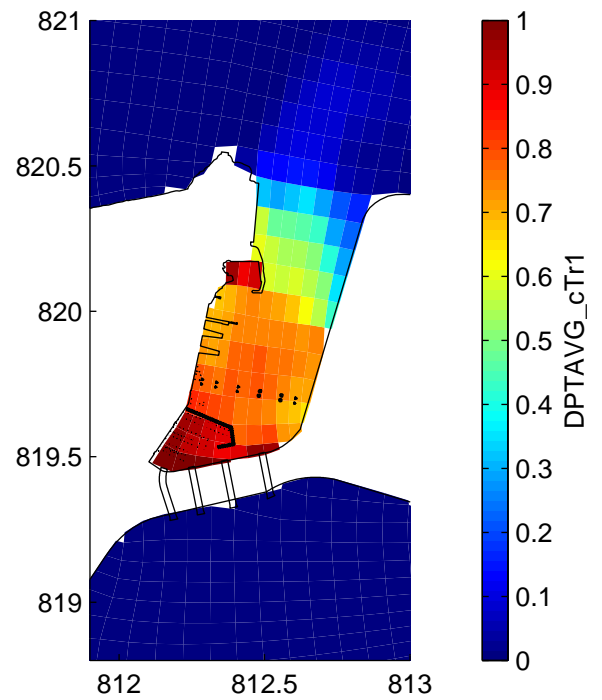
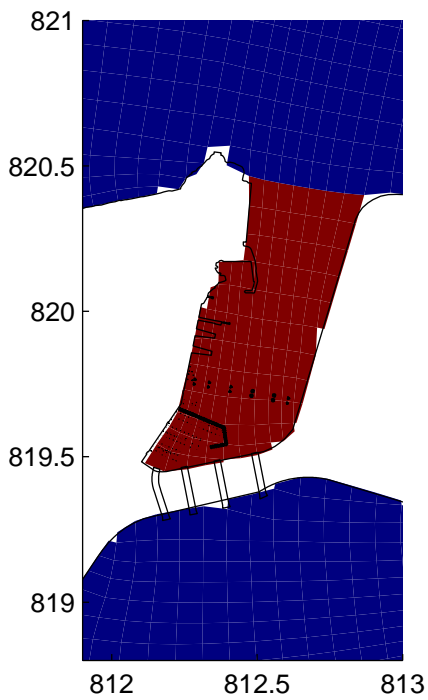
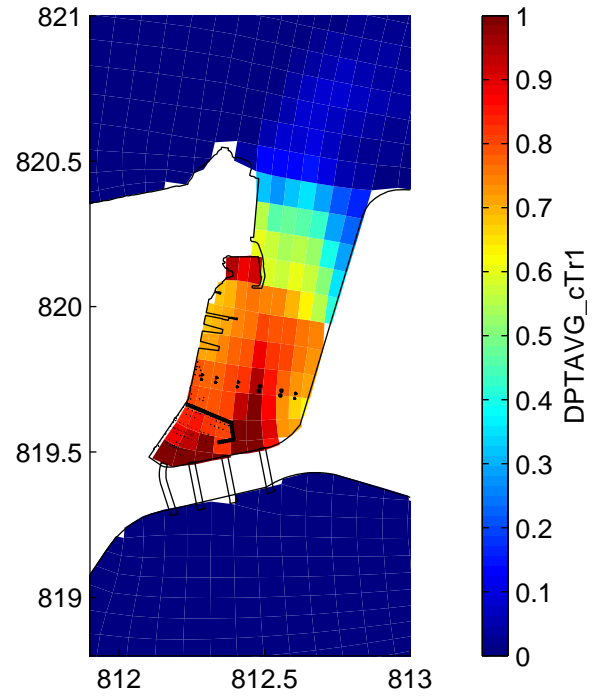
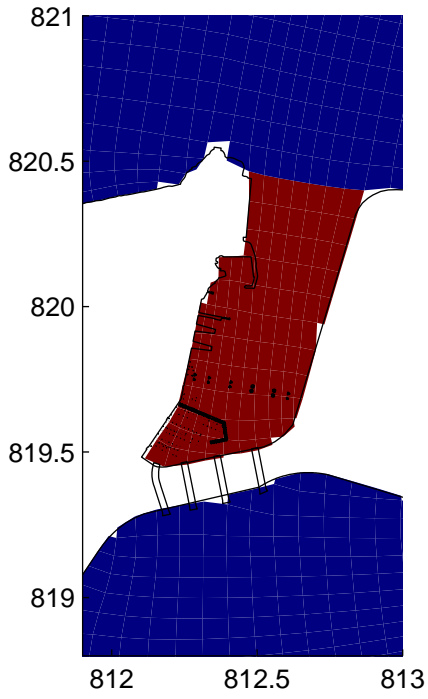

Tracer Concentration During Spring Low Water in Wet season at 0hr & 1 hr
 Top: Baseline; Bottom: Project; Left: 0hr; Right: 1hr

0622478

ERM

WQ/Tracer

Tracer₂.fig

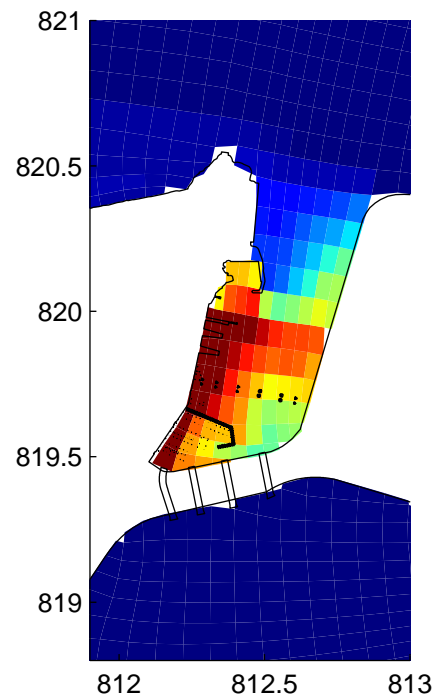
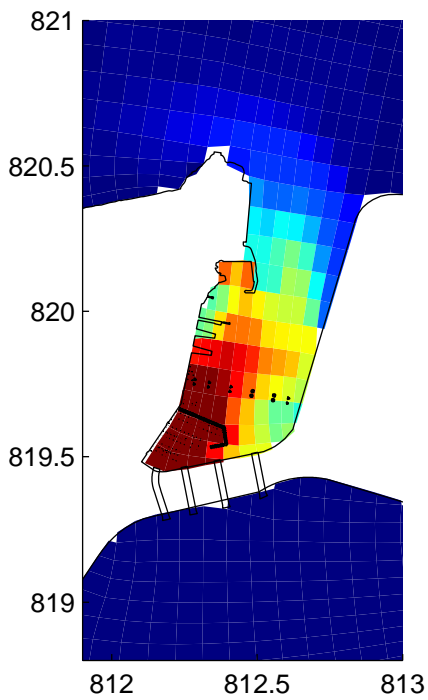
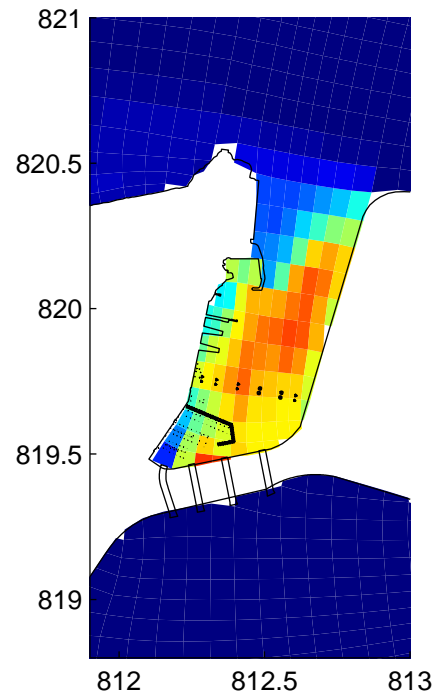
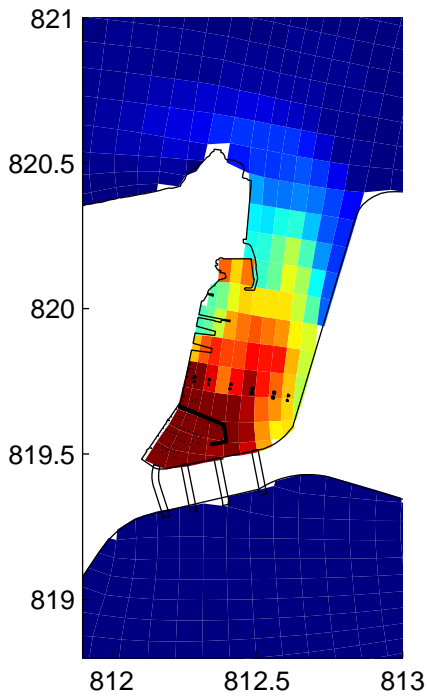

Tracer Concentration During Spring Low Water in Wet season at 2hr & 4 hr
 Top: Baseline; Bottom: Project; Left: 2hr; Right: 4hr

0622478

ERM

WQ/Tracer

Tracer₂.fig

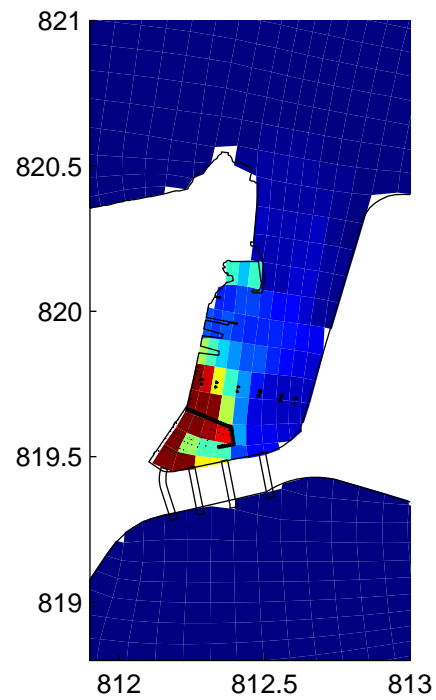
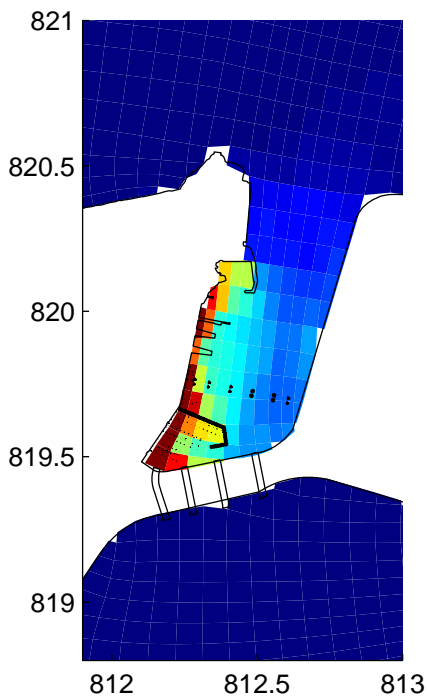
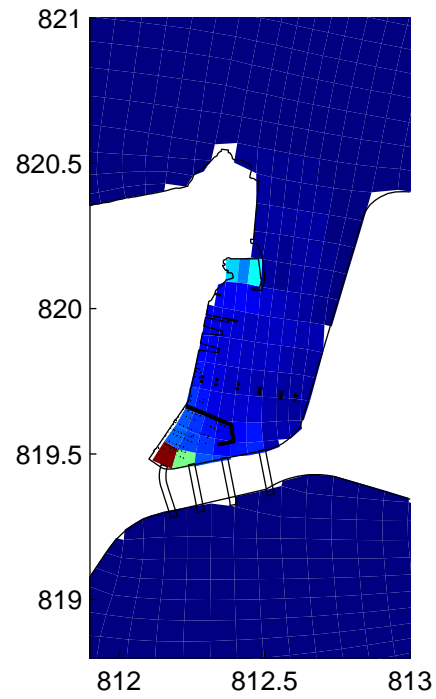
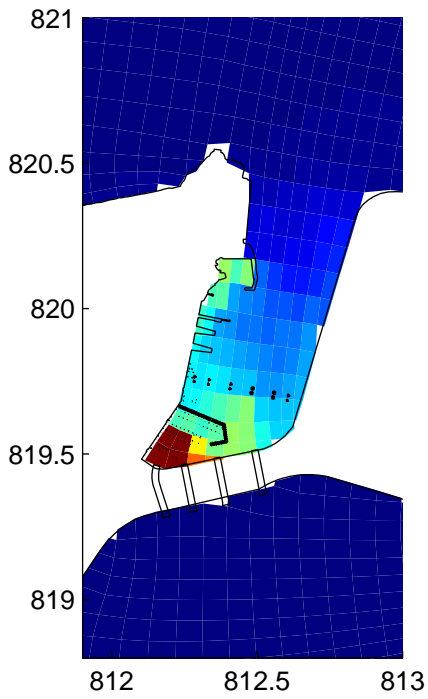

Tracer Concentration During Spring Low Water in Wet season at 8hr & 12 hr
 Top: Baseline; Bottom: Project; Left: 8hr; Right: 12hr

0622478

ERM

WQ/Tracer

Tracer₂.fig

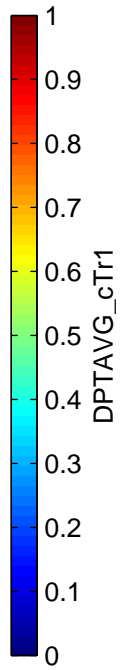
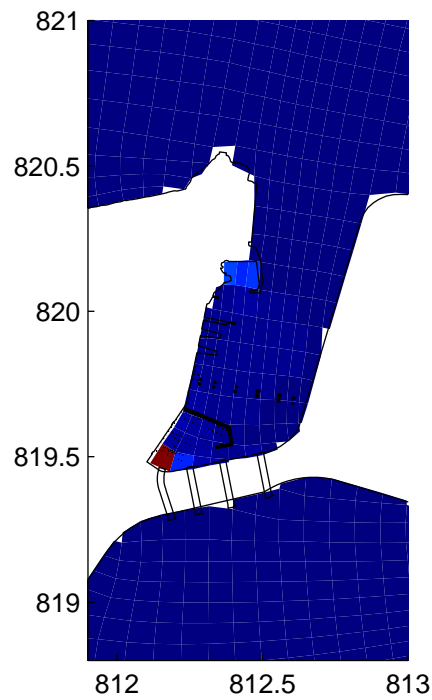
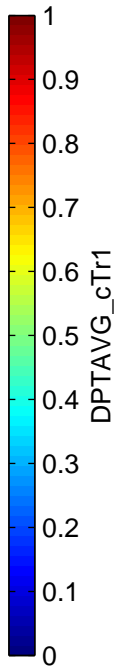
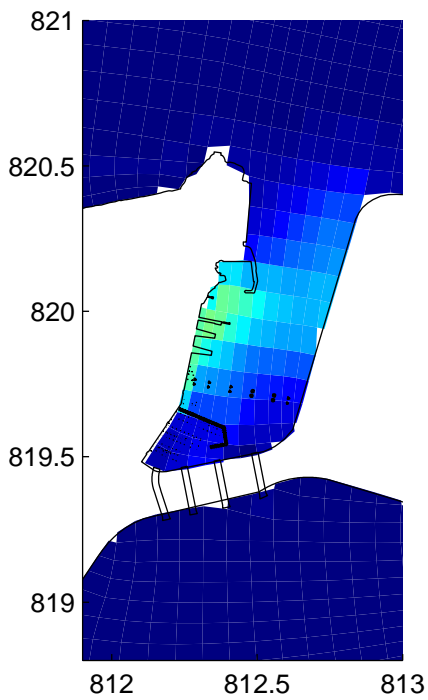
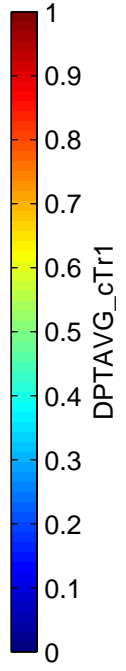
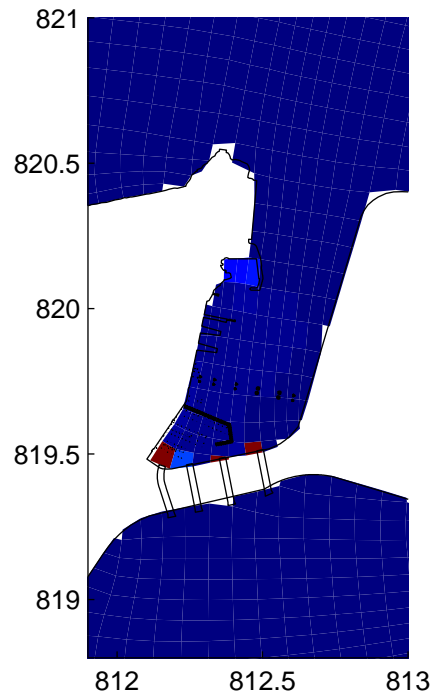
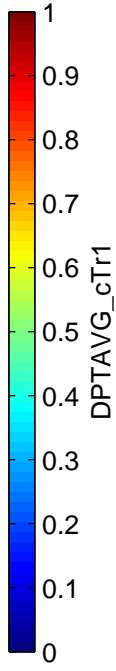
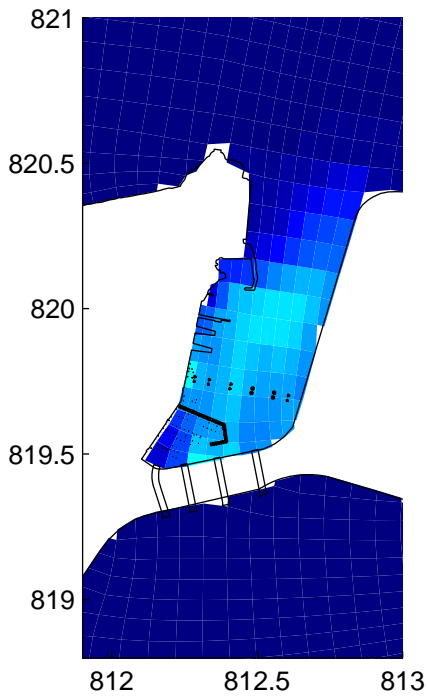

Tracer Concentration During Spring Low Water in Wet season at 16hr & 24 hr
 Top: Baseline; Bottom: Project; Left: 16hr; Right: 24hr

0622478

ERM

WQ/Tracer

Tracer₂.fig

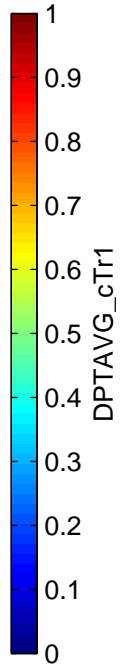
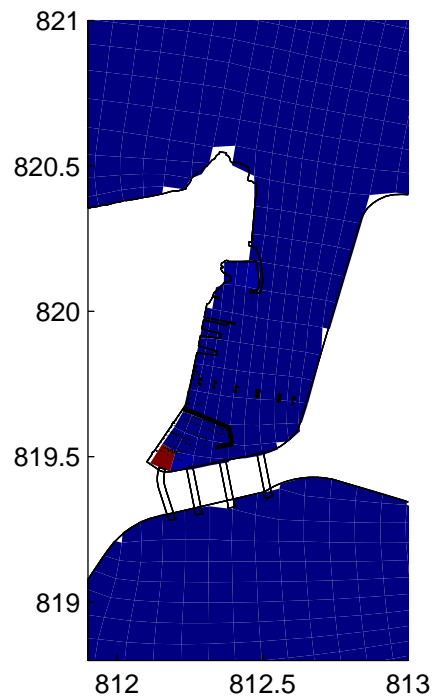
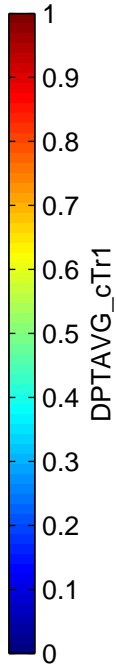
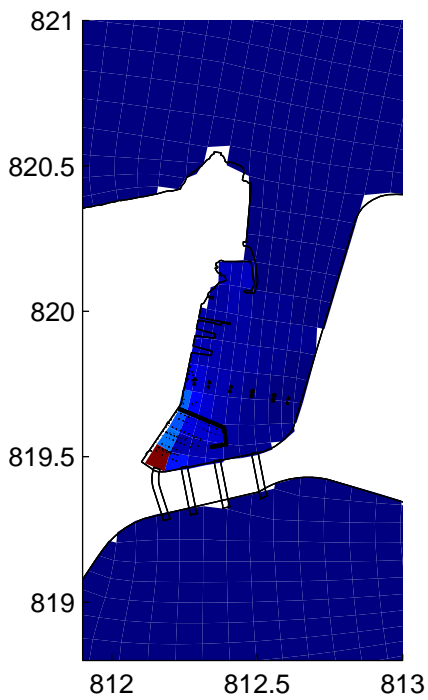
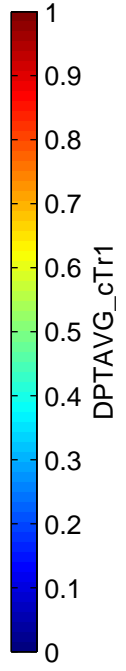
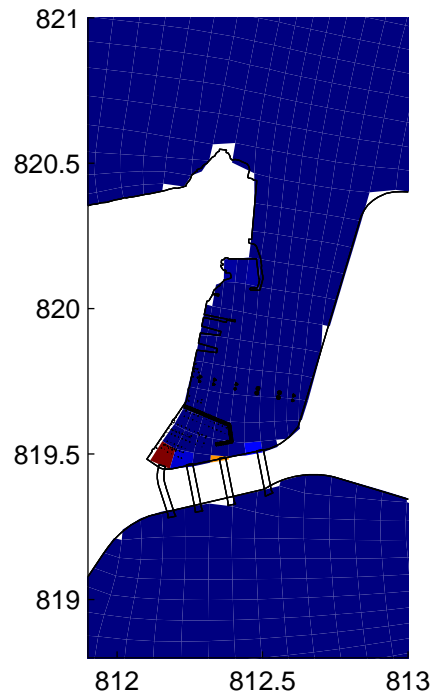
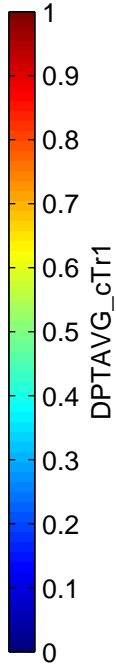
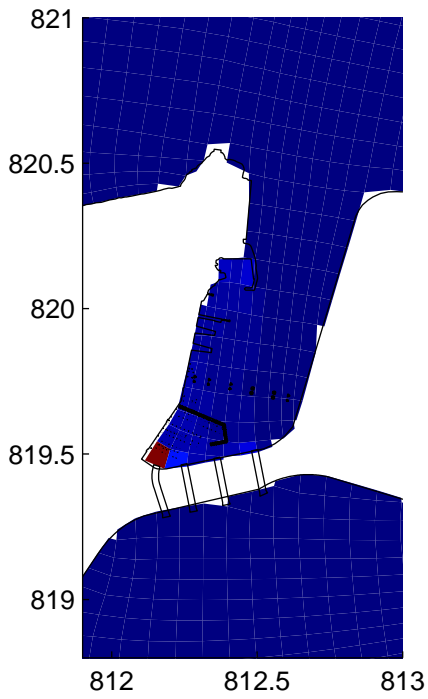

Tracer Concentration During Spring Low Water in Wet season at 36hr & 48 hr
 Top: Baseline; Bottom: Project; Left: 36hr; Right: 48hr

0622478

ERM

WQ/Tracer

Tracer₂.fig